

ZHENXIANG

SPACE CABIN
ACCOMMODATION
MODULE

Constellation Space Capsule
Product Brochure



FOCUS ON SPACE CAPSULE



Tangshan Zhenxiang International Trade Co., Ltd. has been dedicating itself to one-stop solution of prefabricated houses. The service ranges from architectural design, production, storage and transportation to installation instructions and after-sales service etc.

Zhenxiang Steel, located in Tianjin City, covering an area of 62,840 square meters, with more than 1500 employees. Since the establishment in 2005, our production emphasis has gone through the transformation from building structure to integrated housing production. After years of efforts, our products have been exported to Europe, Africa, Southeast Asia, North America, South America and the Middle East. Now, its main products can be divided into five categories, which are folding container house, corrugated container house, expandable container house, detachable container house, steel frame of container house. The annual production capacity for different types of buildings can reach 500,000 square meters. We will always do best to supply the good quality products and perfect service.

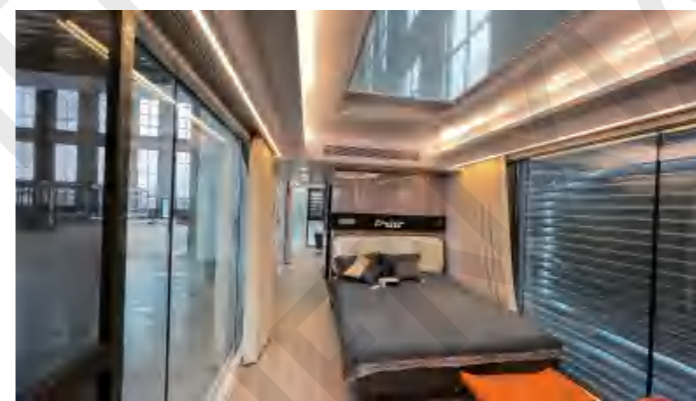

ZHENXIANG

SPACE CABIN ACCOMMODATION MODULE

01

Module Prefabrication,
Integrated Production,
Product Quality Assurance

02

Simple Foundation,
Fast Hoisting,
The most beautiful scenery

03

Removable, does not
harden the ground,
does not destroy plants and trees

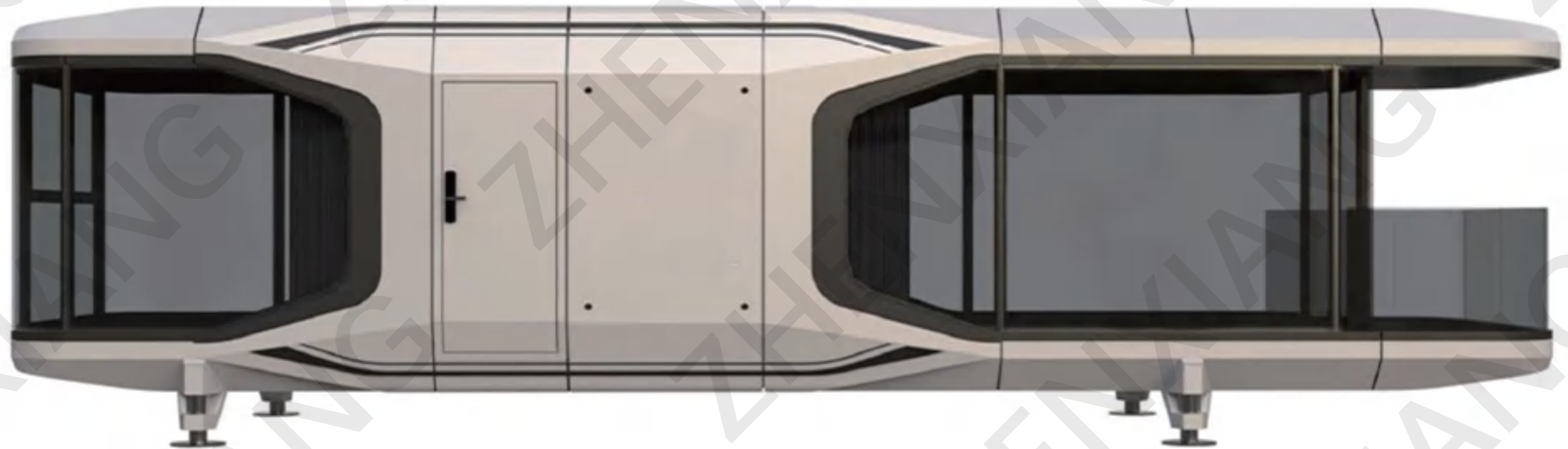

04

Ultra-low energy consumption,
Environmentally Friendly
Sewage Discharge,
0 Pollution to the environment

05

Exquisite Decoration,
Intelligent System,
Check-in with bags

06

Self-contained Traffic,
Online Celebrity IP,
in line with the novelty
hunting psychology

07

Controllable Investment,
High-yield,
Short Cycle, Nice return

ZHENXIANG

SPACE CABIN ACCOMMODATION MODULE

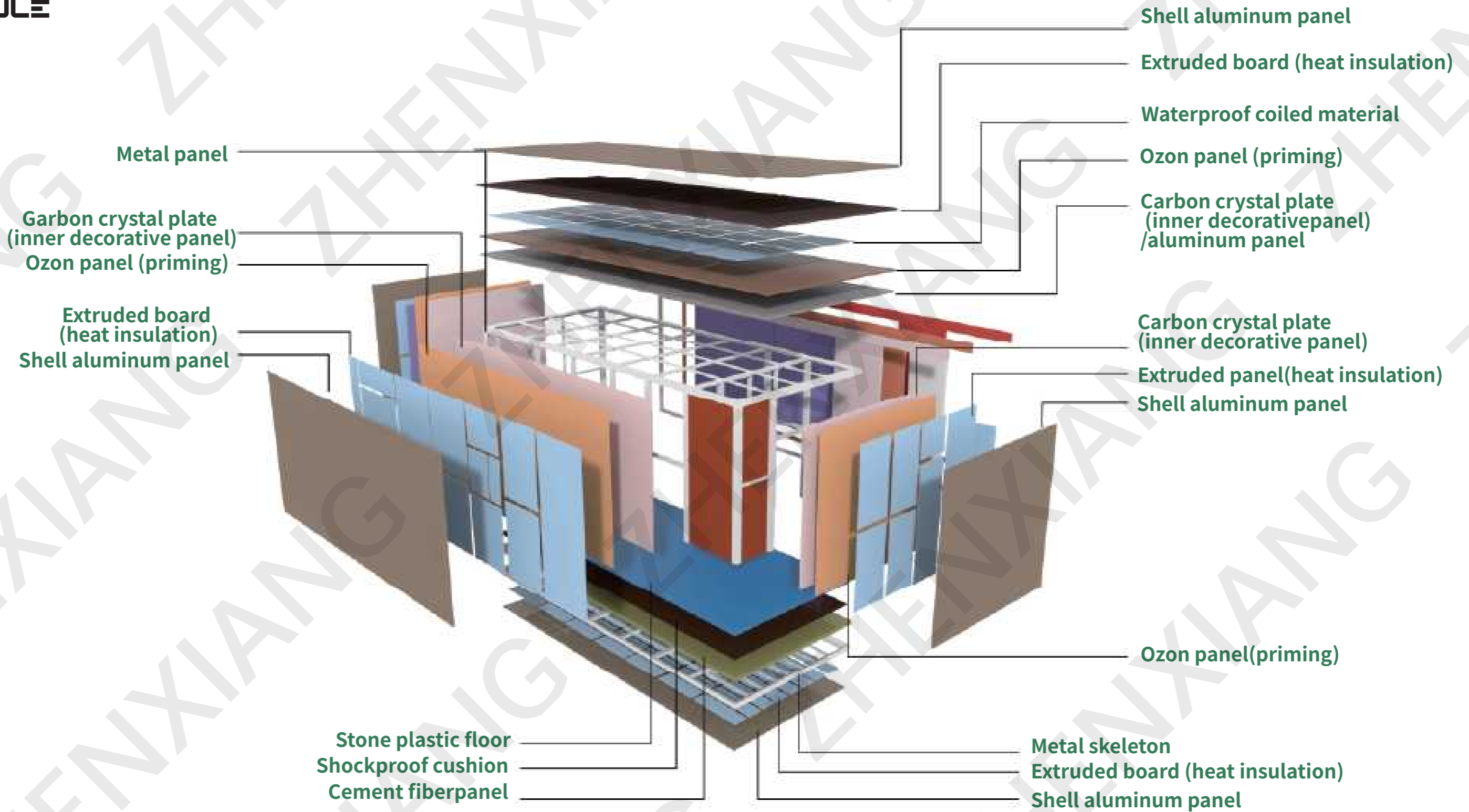

ZHENXIANG

SPACE CABIN ACCOMMODATION MODULE



Product overview

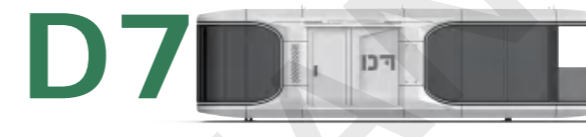
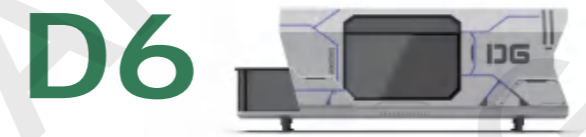

product introduction



DS

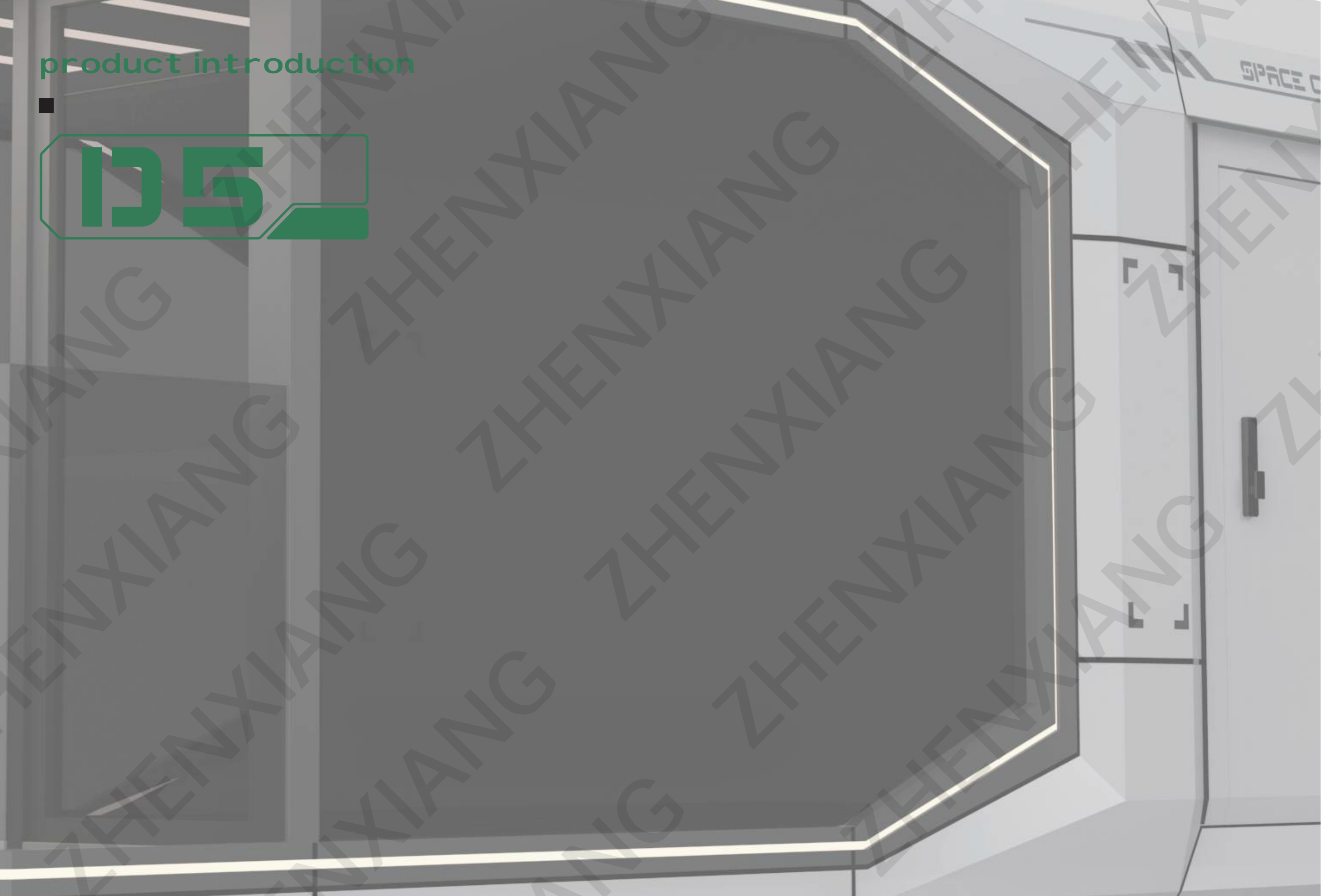

product Picture

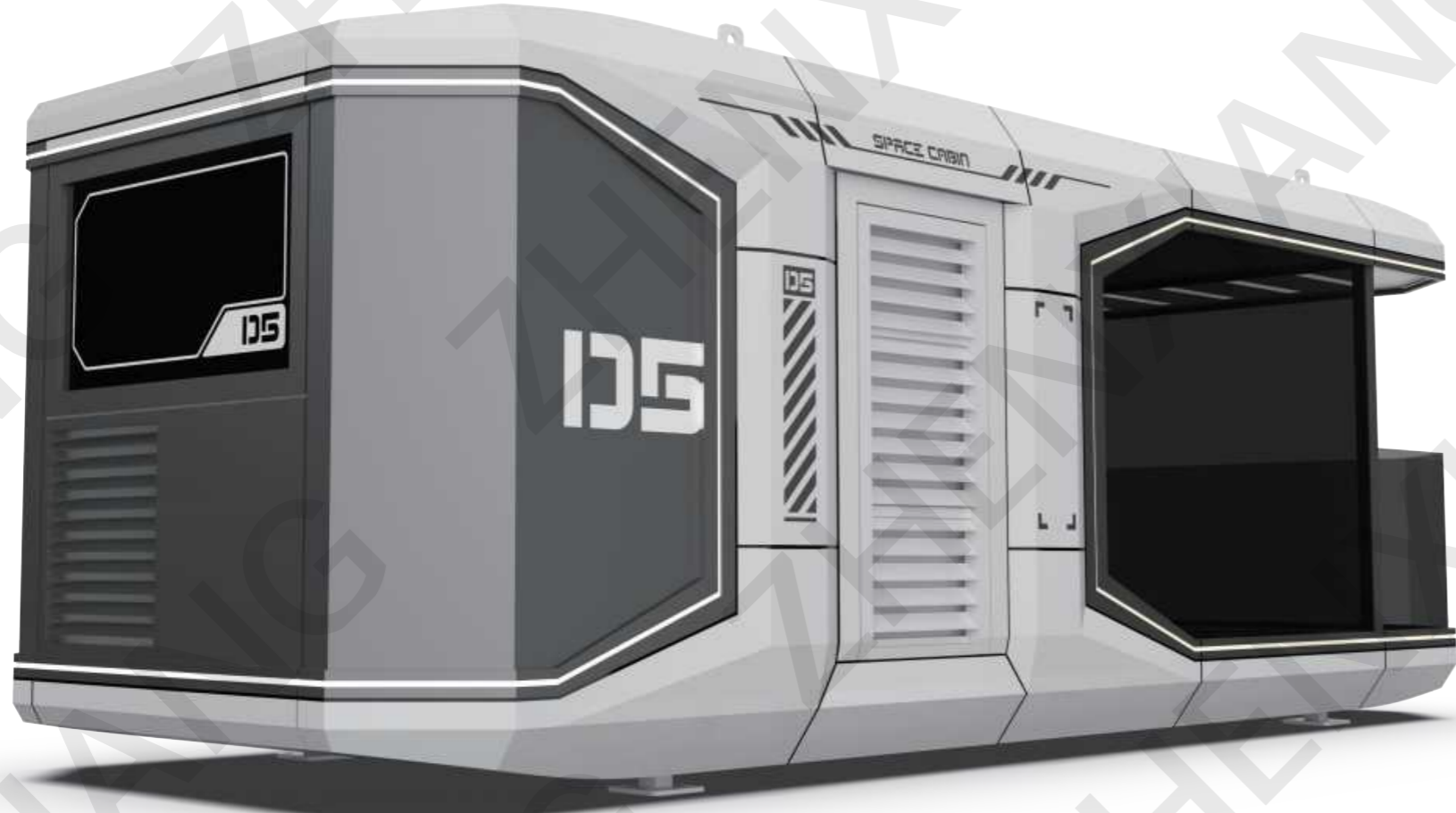

ZHENXIANG

SPACE CABIN
ACCOMMODATION
MODULE

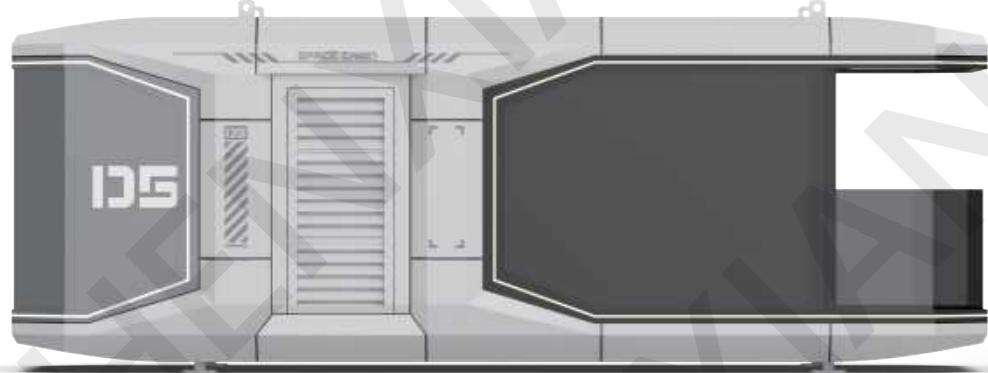

product interior



product interior



ZHENXIANG

SPACE CABIN
ACCOMMODATION MODULE



configuration instructions

ZHENXIANG

SPACE CABIN ACCOMMODATION MODULE

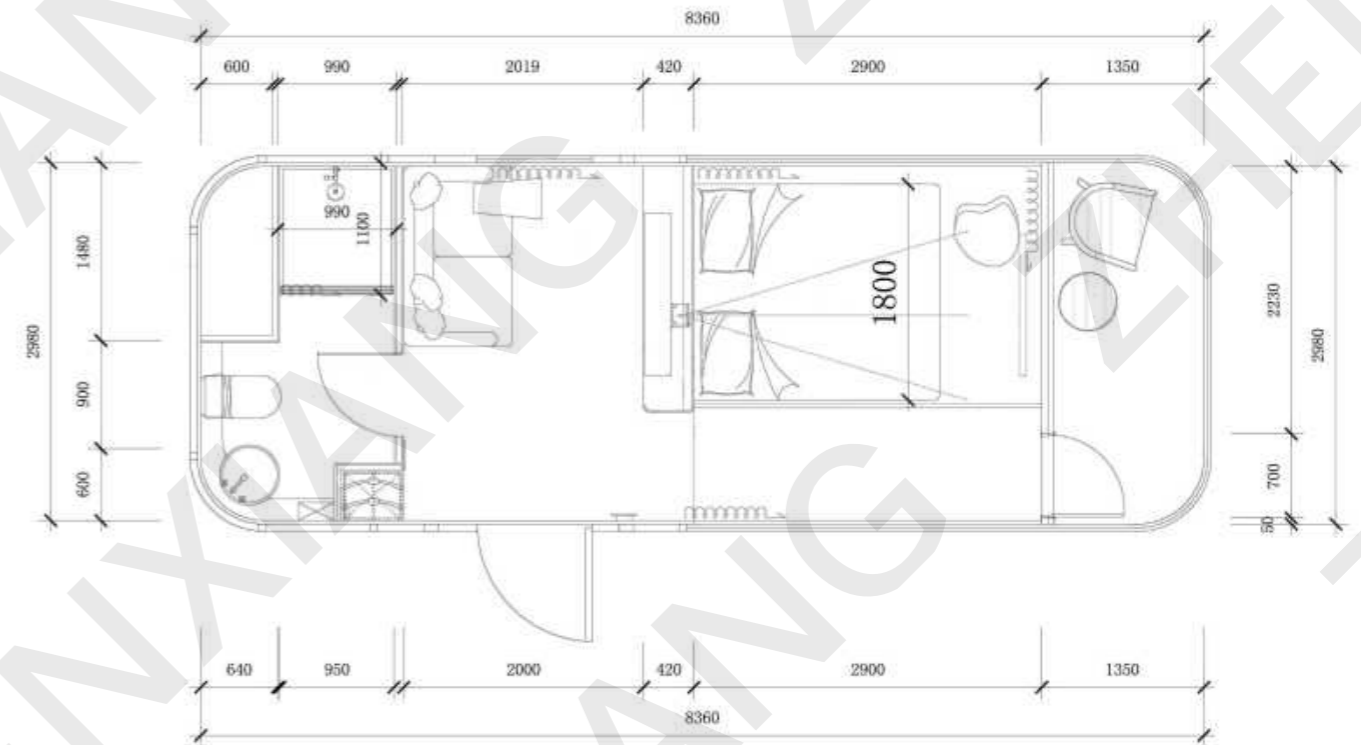
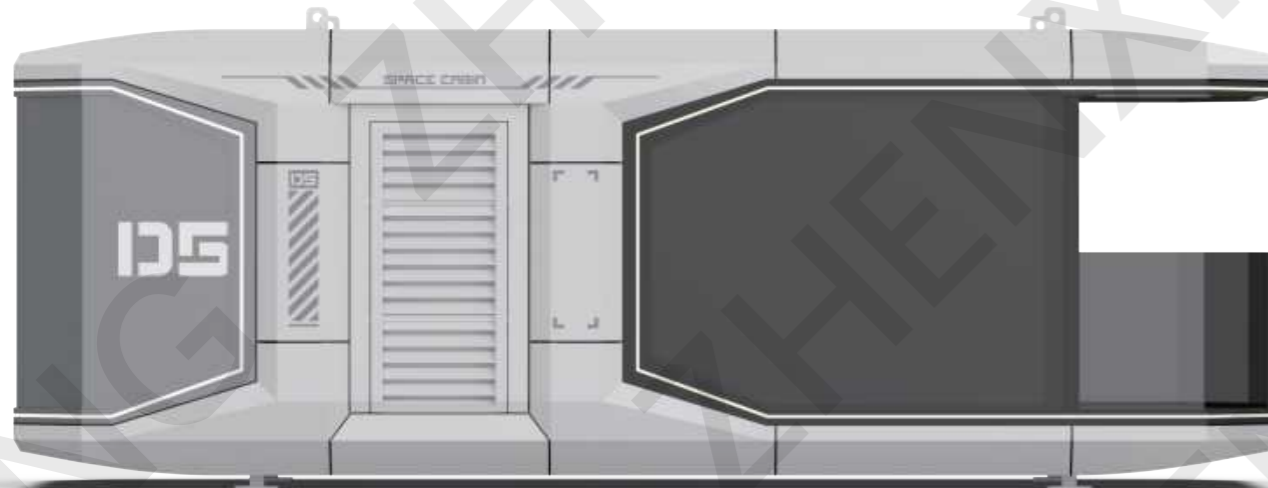

*Subject to The Actual Product

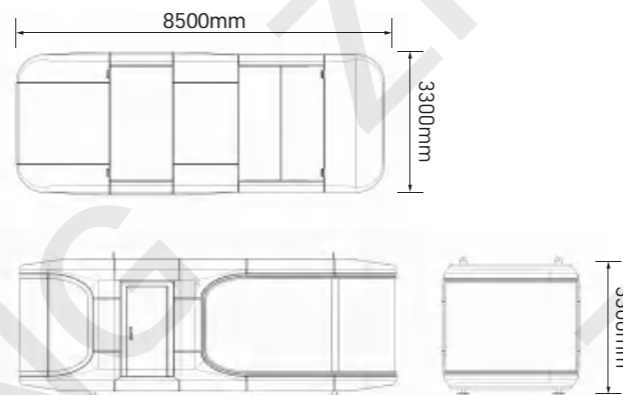

Configuration instructions	
Dimensions	8500mm*3300mm*3300mm
Floor Area	28.4m ²
Occupancy	2
Power consumption	12KW
Approximate total weight	5ton

Extracorporeal structure		
No.	Structure	Material
1	Steel structure frame	Steel structure frame
2	Exterior wall panels	Aluminum
3	Heat insulation	100mm polyurethane insulation layer
4	External wall glass	6+18A+6 hollow LOW-E glass or 6+6 amine insulating glass
5	Shell surface treatment	Metal fluorocarbon paint baking paint
6	Balcony	Panoramic balcony (10mm tempered glass)
7	Peripheral light strip	Peripheral light strip (surrounding ambient light strip)
8	Entrance door	Intelligent access control system

Eco-friendly fine decoration inside Structural materials		
No.	Structure	Material
9	Ceiling	Can be decorated with integrated board
10	Wall surface	Can be decorated with integrated board
11	Floor	High-grade wood grain lock floor
12	Indoor lighting effect	3000K warm yellow light
13	Outdoor lighting effect	4000K warm white light
14	Control system	The whole house integrated intelligent control system
15	Socket panel	Brand switch panel

Whole house equipment		
No.	Structure	Material
16	Air conditioner	Ducted air conditioner
17	Yuba	Air-heated three-in-one integrated bathroom

configuration instructions

ZHENXIANG

SPACE CABIN ACCOMMODATION MODULE

Bathroom Fittings		
No.	Structure	Material
18	Bathroom privacy door	Frosted tempered glass
19	Hanger Towel Rack	Hanger Towel Rack
20	Shower	50L bucket water heater
21	Basin	Above counter basin
22	Toilet	Smart toilet
23	Faucet	Tall faucet

Other Accessories	
No.	Structure
24	Shipping Fixtures/Connectors

Optional accessories	
No.	Structure
25	Curtain
26	Electric curtain
27	Plug in card power/take card power
28	Floor heating: Electric floor heating
29	Pipeline antifreeze: electric heat tracing
30	Audio-visual equipment: Projector
31	Skylight
32	Circulation ventilation system
33	Security alarm: smoke
34	Multi-scene mode function panel
35	Intelligent lighting control
36	Intelligent curtain control
37	Intelligent voice system
38	Hotel link system



PRODUCT INTRODUCTION

ZHENXIANG

SPACE CABIN ACCOMMODATION MODULE



PRODUCT INTRODUCTION

ZHENXIANG

SPACE CABIN ACCOMMODATION MODULE



product introduction



product Picture



ZHENXIANG

**SPACE CABIN
ACCOMMODATION
MODULE**



product interior



product interior

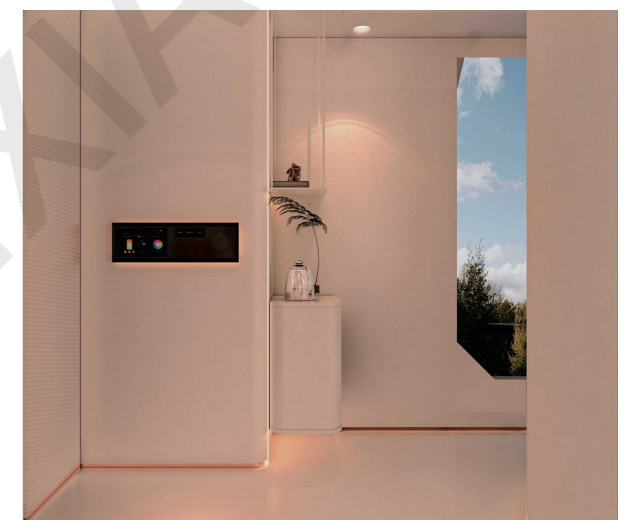

configuration instructions

ZHENXIANG

SPACE CABIN ACCOMMODATION MODULE

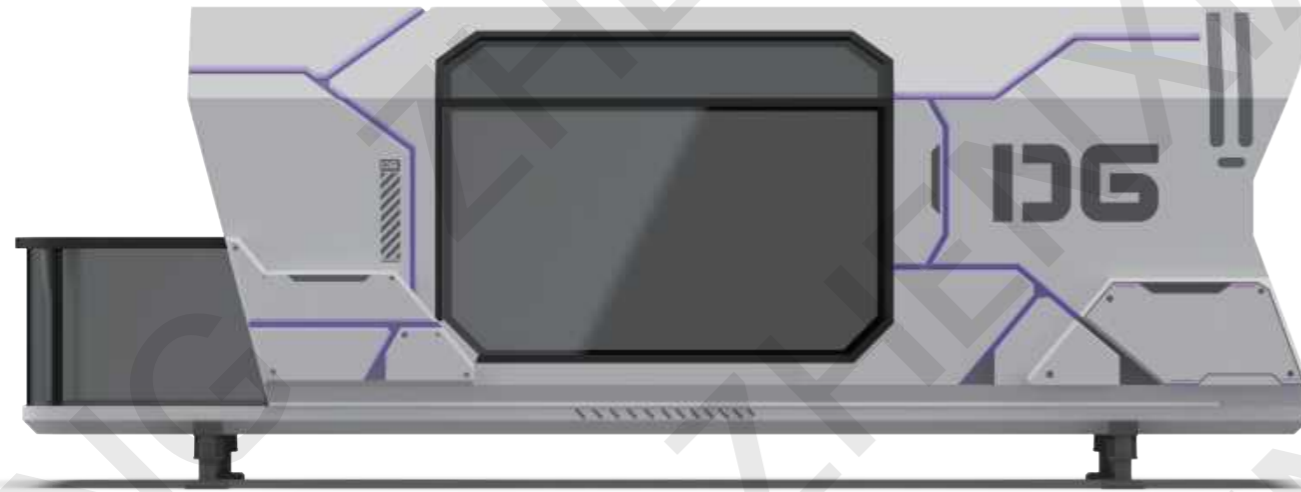

*Subject to The Actual Product

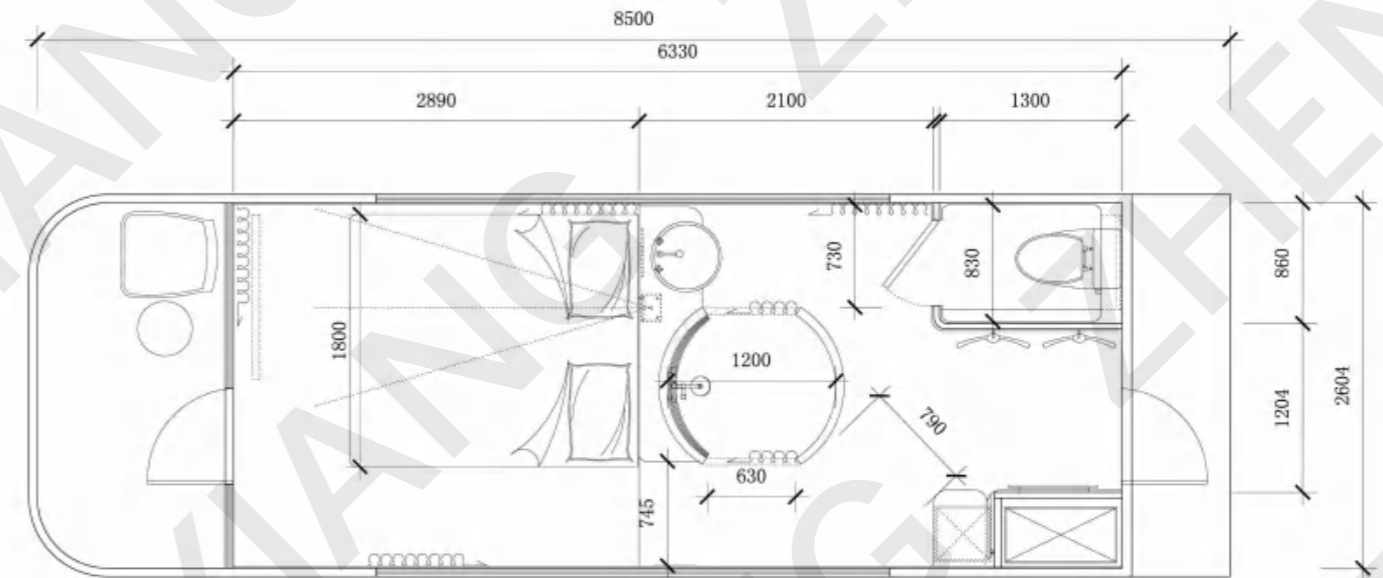

Configuration instructions	
Dimensions	8600mm*3300mm*3300mm
Floor Area	28.4m ²
Occupancy	2
Power consumption	12KW
Approximate total weight	5ton

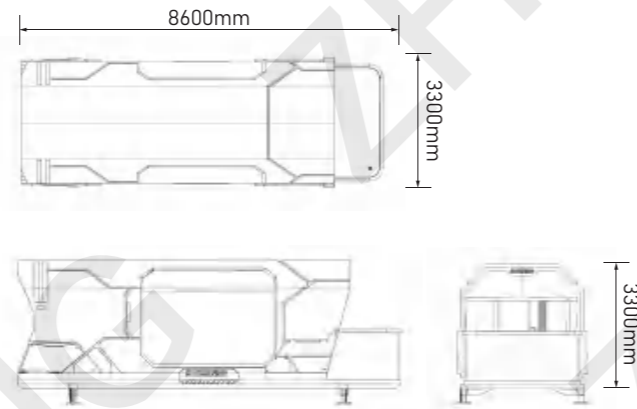

Extracorporeal structure		
No.	Structure	Material
1	Steel structure frame	Steel structure frame
2	Exterior wall panels	Aluminum
3	Heat insulation	100mm polyurethane insulation layer
4	External wall glass	6+18A+6 hollow LOW-E glass or 6+6 amine insulating glass
5	Shell surface treatment	Metal fluorocarbon paint baking paint
6	Balcony	Panoramic balcony (10mm tempered glass)
7	Peripheral light strip	Peripheral light strip (surrounding ambient light strip)
8	Entrance door	Intelligent access control system

Eco-friendly fine decoration inside Structural materials		
No.	Structure	Material
9	Ceiling	Can be decorated with integrated board
10	Wall surface	Can be decorated with integrated board
11	Floor	High-grade wood grain lock floor
12	Indoor lighting effect	3000K warm yellow light
13	Outdoor lighting effect	4000K warm white light
14	Control system	The whole house integrated intelligent control system
15	Socket panel	Brand switch panel

Whole house equipment		
No.	Structure	Material
16	Air conditioner	Ducted air conditioner
17	Yuba	Air-heated three-in-one integrated bathroom

configuration instructions



Bathroom Fittings		
No.	Structure	Material
18	Bathroom privacy door	Frosted tempered glass
19	Hanger Towel Rack	Hanger Towel Rack
20	Shower	50L bucket water heater
21	Basin	Above counter basin
22	Toilet	Smart toilet
23	Faucet	Tall faucet

Other Accessories	
No.	Structure
24	Shipping Fixtures/Connectors

Optional accessories			
No.	Structure	No.	Structure
25	Curtain	32	Circulation ventilation system
26	Electric curtain	33	Security alarm: smoke
27	Plug in card power/take card power	34	Multi-scene mode function panel
28	Floor heating: Electric floor heating	35	Intelligent lighting control
29	Pipeline antifreeze: electric heat tracing	36	Intelligent curtain control
30	Audio-visual equipment: Projector	37	Intelligent voice system
31	Skylight	38	Hotel link system

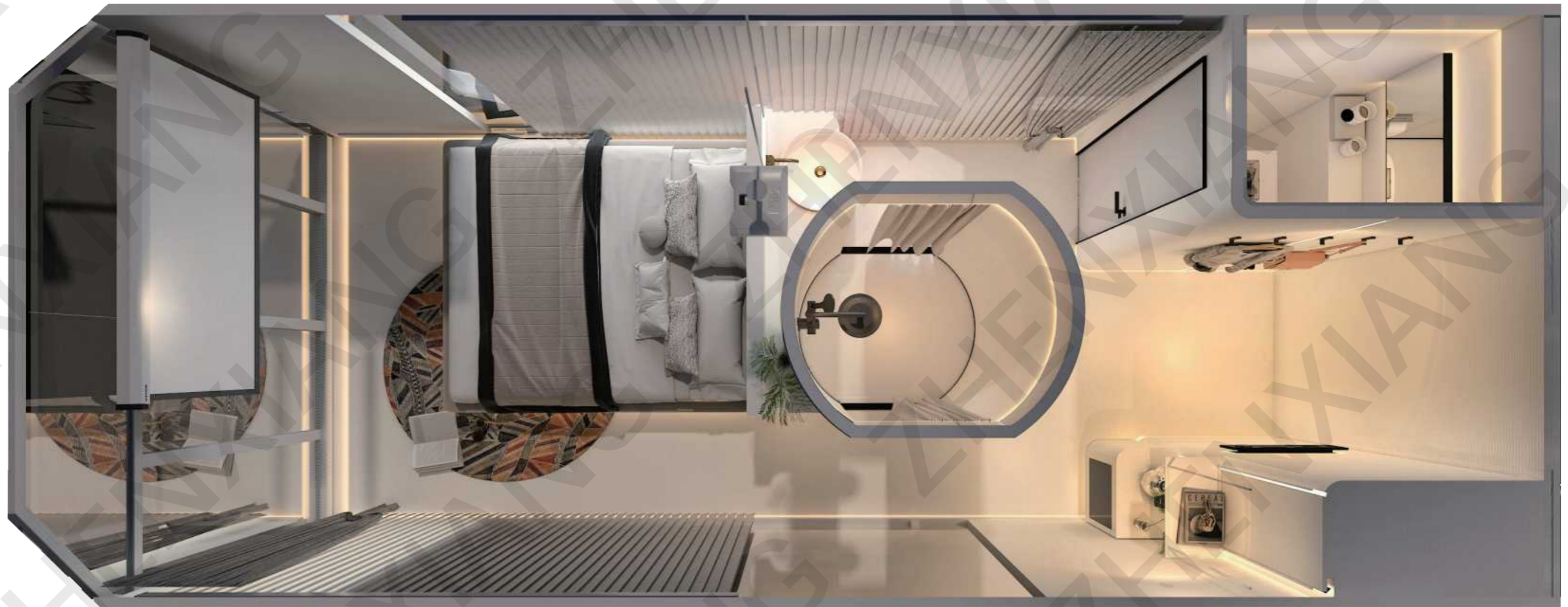

PRODUCT INTRODUCTION

ZHENXIANG

SPACE CABIN ACCOMMODATION MODULE



PRODUCT INTRODUCTION

ZHENXIANG

SPACE CABIN ACCOMMODATION MODULE



product introduction

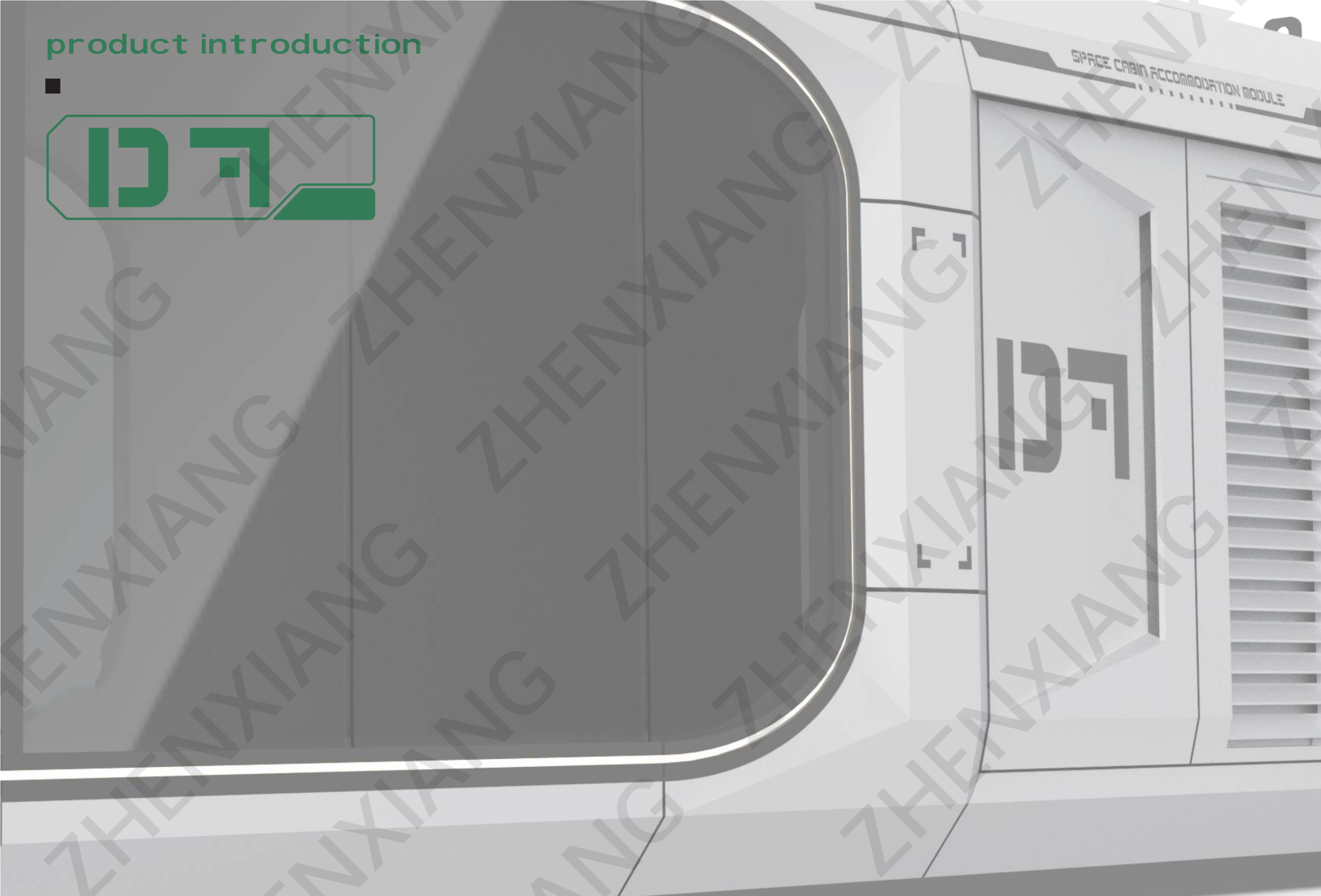

product Picture

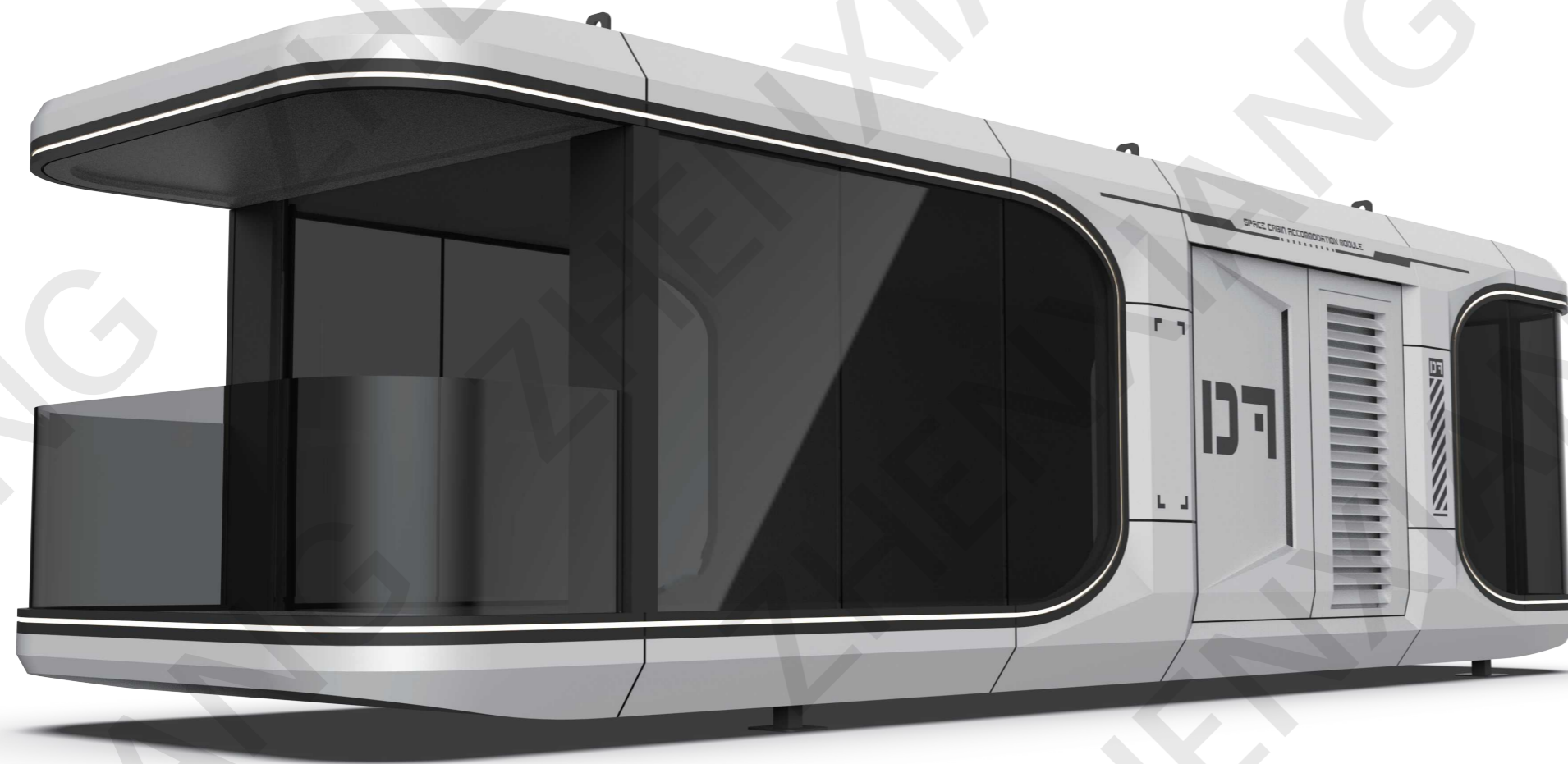

ZHENXIANG

**SPACE CABIN
ACCOMMODATION
MODULE**

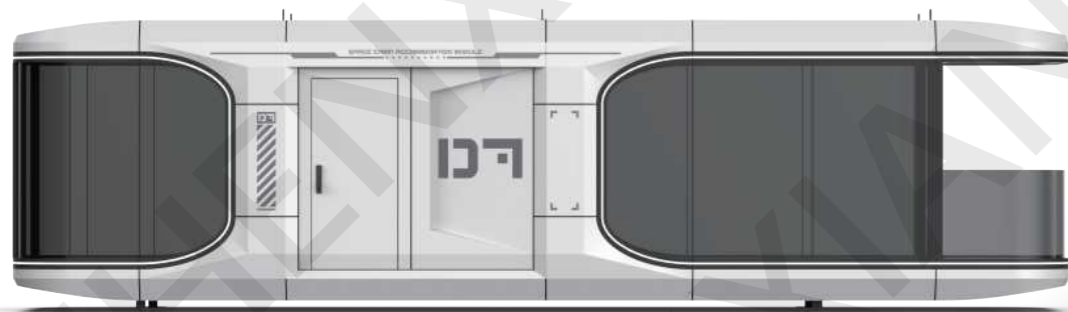

product interior



product interior



configuration instructions

ZHENXIANG

SPACE CABIN ACCOMMODATION MODULE

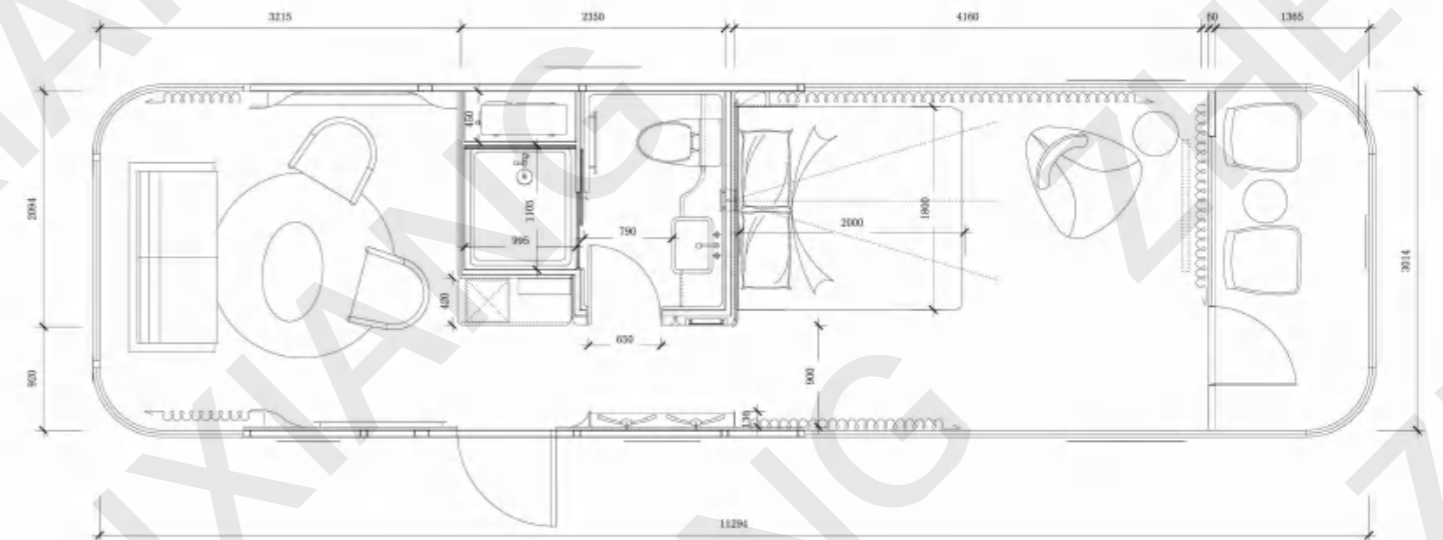

*Subject to The Actual Product

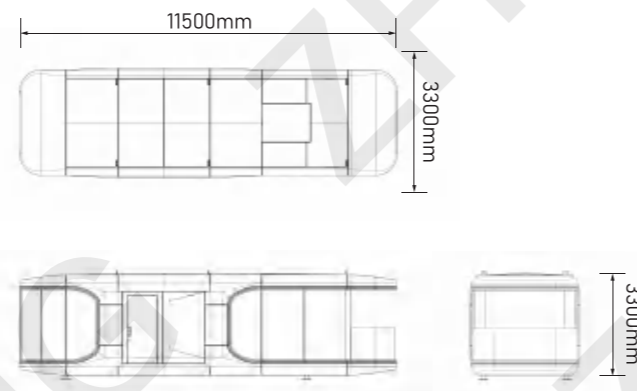

Configuration instructions	
Dimensions	11500mm*3300mm*3300mm
Floor Area	38m ²
Occupancy	2
Power consumption	12KW
Approximate total weight	9.5ton

Extracorporeal structure		
No.	Structure	Material
1	Steel structure frame	Steel structure frame
2	Exterior wall panels	Aluminum
3	Heat insulation	100mm polyurethane insulation layer
4	External wall glass	6+18A+6 hollow LOW-E glass or 6+6 amine insulating glass
5	Shell surface treatment	Metal fluorocarbon paint baking paint
6	Balcony	Panoramic balcony (10mm tempered glass)
7	Peripheral light strip	Peripheral light strip (surrounding ambient light strip)
8	Entrance door	Intelligent access control system

Eco-friendly fine decoration inside Structural materials		
No.	Structure	Material
9	Ceiling	Can be decorated with integrated board
10	Wall surface	Can be decorated with integrated board
11	Floor	High-grade wood grain lock floor
12	Indoor lighting effect	3000K warm yellow light
13	Outdoor lighting effect	4000K warm white light
14	Control system	The whole house integrated intelligent control system
15	Socket panel	Brand switch panel

Whole house equipment		
No.	Structure	Material
16	Air conditioner	Ducted air conditioner
17	Yuba	Air-heated three-in-one integrated bathroom

configuration instructions

ZHENXIANG

SPACE CABIN ACCOMMODATION MODULE

Bathroom Fittings		
No.	Structure	Material
18	Bathroom privacy door	Frosted tempered glass
19	Hanger Towel Rack	Hanger Towel Rack
20	Shower	50L bucket water heater
21	Basin	Above counter basin
22	Toilet	Smart toilet
23	Faucet	Tall faucet

Other Accessories	
No.	Structure
24	Shipping Fixtures/Connectors

Optional accessories			
No.	Structure	No.	Structure
25	Curtain	32	Circulation ventilation system
26	Electric curtain	33	Security alarm: smoke
27	Plug in card power/take card power	34	Multi-scene mode function panel
28	Floor heating: Electric floor heating	35	Intelligent lighting control
29	Pipeline antifreeze: electric heat tracing	36	Intelligent curtain control
30	Audio-visual equipment: Projector	37	Intelligent voice system
31	Skylight	38	Hotel link system



PRODUCT INTRODUCTION

ZHENXIANG

SPACE CABIN ACCOMMODATION MODULE



PRODUCT INTRODUCTION

ZHENXIANG

SPACE CABIN ACCOMMODATION MODULE



product introduction



D9

X-Inspace

Science fiction-like life
Technology inspiration Beyond time and space
Technology / Intelligent caravan

CAUTION

MOBILE CAPSULE RESIDENCE

product Picture



product interior



product interior



configuration instructions

ZHENXIANG

SPACE CABIN ACCOMMODATION MODULE

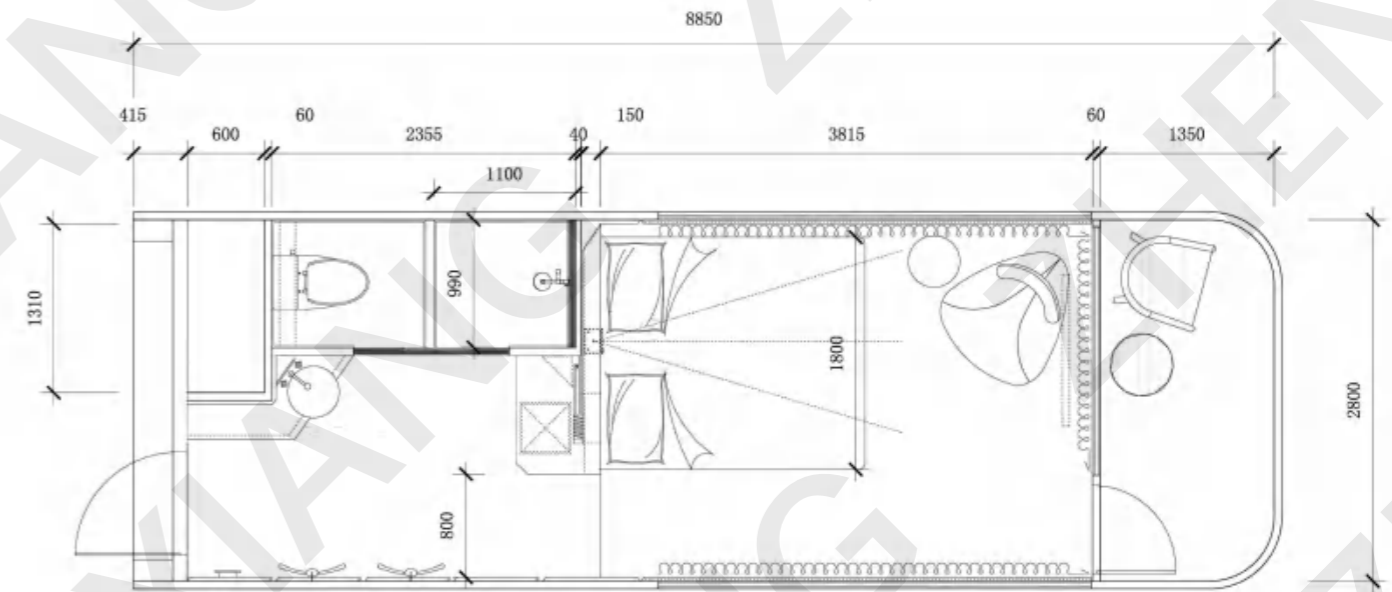
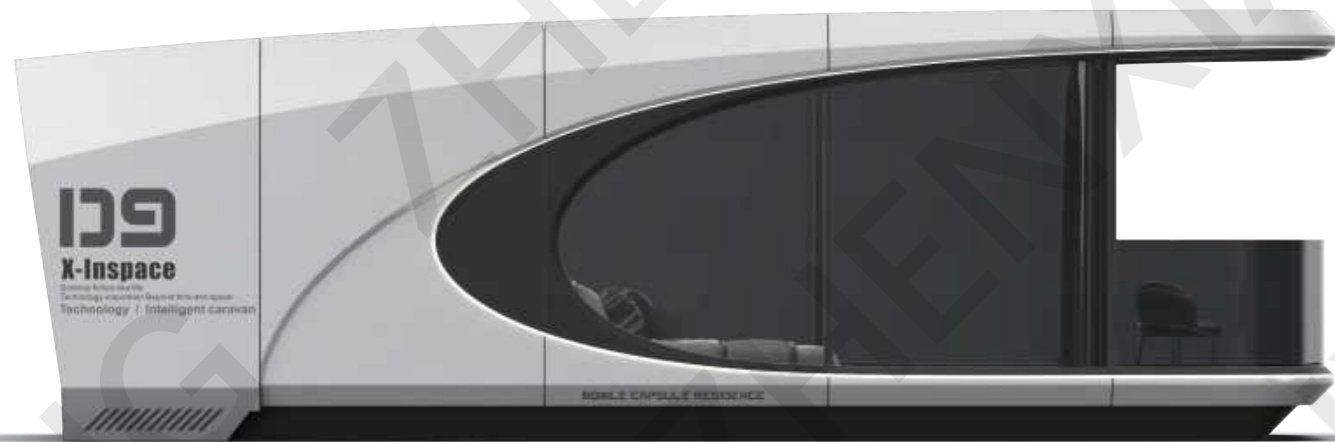

*Subject to The Actual Product

产品信息 (Configuration instructions)	
Dimensions	9400mm*3100mm*3300mm
Floor Area	29.7m ²
Occupancy	2
Power consumption	12KW
Approximate total weight	8 ton

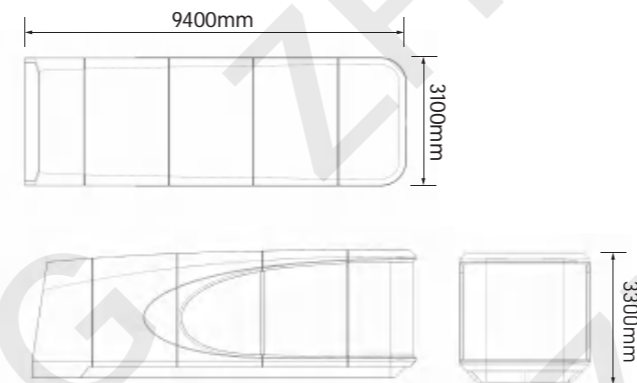

Extracorporeal structure		
No.	Structure	Material
1	Steel structure frame	Steel structure frame
2	Exterior wall panels	Aluminum
3	Heat insulation	100mm polyurethane insulation layer
4	External wall glass	6+18A+6 hollow LOW-E glass or 6+6 amine insulating glass
5	Shell surface treatment	Metal fluorocarbon paint baking paint
6	Balcony	Panoramic balcony (10mm tempered glass)
7	Peripheral light strip	Peripheral light strip (surrounding ambient light strip)
8	Entrance door	Intelligent access control system

Eco-friendly fine decoration inside Structural materials		
No.	Structure	Material
9	Ceiling	Can be decorated with integrated board
10	Wall surface	Can be decorated with integrated board
11	Floor	High-grade wood grain lock floor
12	Indoor lighting effect	3000K warm yellow light
13	Outdoor lighting effect	4000K warm white light
14	Control system	The whole house integrated intelligent control system
15	Socket panel	Brand switch panel

Whole house equipment		
No.	Structure	Material
16	Air conditioner	Ducted air conditioner
17	Yuba	Air-heated three-in-one integrated bathroom

configuration instructions

ZHENXIANG

SPACE CABIN ACCOMMODATION MODULE



Other Accessories	
No.	Structure
24	Shipping Fixtures/Connectors

Optional accessories			
No.	Structure	No.	Structure
25	Curtain	32	Circulation ventilation system
26	Electric curtain	33	Security alarm: smoke
27	Plug in card power/take card power	34	Multi-scene mode function panel
28	Floor heating: Electric floor heating	35	Intelligent lighting control
29	Pipeline antifreeze: electric heat tracing	36	Intelligent curtain control
30	Audio-visual equipment: Projector	37	Intelligent voice system
31	Skylight	38	Hotel link system

Bathroom Fittings		
No.	Structure	Material
18	Bathroom privacy door	Frosted tempered glass
19	Hanger Towel Rack	Hanger Towel Rack
20	Shower	50L bucket water heater
21	Basin	Above counter basin
22	Toilet	Smart toilet
23	Faucet	Tall faucet

PRODUCT INTRODUCTION

ZHENXIANG

SPACE CABIN ACCOMMODATION MODULE



01

X-Inspace

Science fiction-like life
Technology inspiration Beyond time and space
Technology Intelligent caravan

PRODUCT INTRODUCTION

ZHENXIANG

SPACE CABIN ACCOMMODATION MODULE



01

X-Inspace

Science fiction-like life
Technology Inspiration Beyond time and space
Technology / Intelligent caravan

SPACE CABIN

product introduction

02

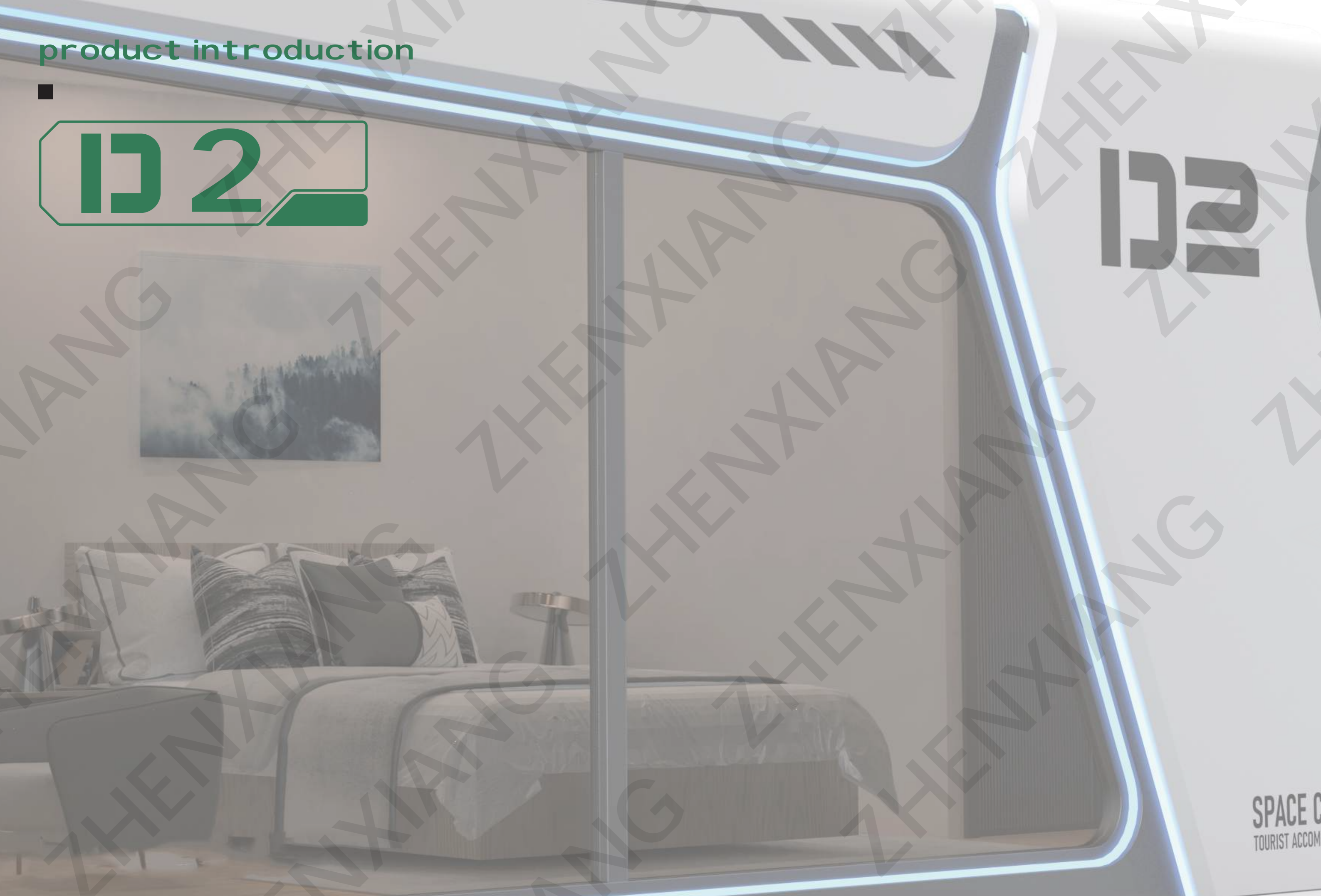

SPACE C
TOURIST ACCOM

product Picture



NANXIANG

SPACE CABIN ACCOMMODATION MODULE



configuration instructions

NANXIANG

SPACE CABIN ACCOMMODATION MODULE

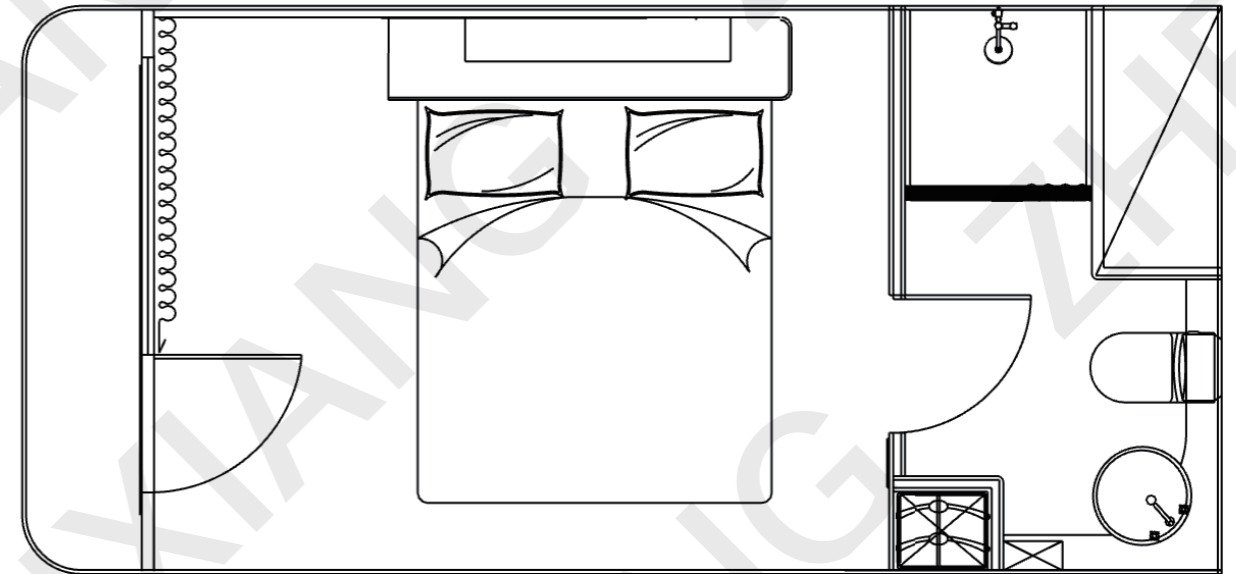

*Subject to The Actual Product

Configuration instructions	
Dimensions	7000mm*3000mm*3200mm
Floor Area	22.4m ²
Occupancy	2
Power consumption	12KW
Approximate total weight	6ton

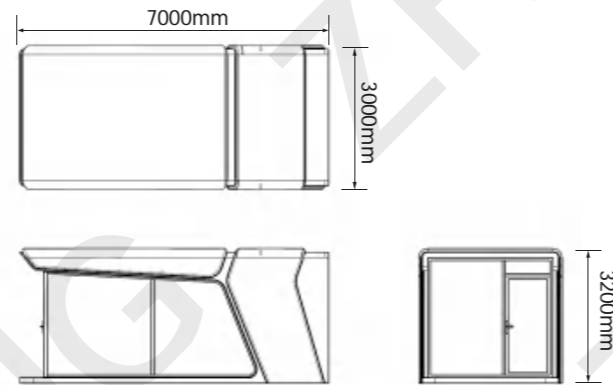

Extracorporeal structure		
No.	Structure	Material
1	Steel structure frame	Steel structure frame
2	Exterior wall panels	Aluminum
3	Heat insulation	100mm polyurethane insulation layer
4	External wall glass	6+18A+6 hollow LOW-E glass or 6+6 amine insulating glass
5	Shell surface treatment	Metal fluorocarbon paint baking paint
6	Balcony	Panoramic balcony (10mm tempered glass)
7	Peripheral light strip	Peripheral light strip (surrounding ambient light strip)
8	Entrance door	Intelligent access control system

Eco-friendly fine decoration inside Structural materials		
No.	Structure	Material
9	Ceiling	Can be decorated with integrated board
10	Wall surface	Can be decorated with integrated board
11	Floor	High-grade wood grain lock floor
12	Indoor lighting effect	3000K warm yellow light
13	Outdoor lighting effect	4000K warm white light
14	Control system	The whole house integrated intelligent control system
15	Socket panel	Brand switch panel

Whole house equipment		
No.	Structure	Material
16	Air conditioner	Ducted air conditioner
17	Yuba	Air-heated three-in-one integrated bathroom

configuration instructions

NANXIANG

SPACE CABIN ACCOMMODATION MODULE

Bathroom Fittings		
No.	Structure	Material
18	Bathroom privacy door	Frosted tempered glass
19	Hanger Towel Rack	Hanger Towel Rack
20	Shower	50L bucket water heater
21	Basin	Above counter basin
22	Toilet	Smart toilet
23	Faucet	Tall faucet

Other Accessories	
No.	Structure
24	Shipping Fixtures/Connectors

Optional accessories			
No.	Structure	No.	Structure
25	Curtain	32	Circulation ventilation system
26	Electric curtain	33	Security alarm: smoke
27	Plug in card power/take card power	34	Multi-scene mode function panel
28	Floor heating: Electric floor heating	35	Intelligent lighting control
29	Pipeline antifreeze: electric heat tracing	36	Intelligent curtain control
30	Audio-visual equipment: Projector	37	Intelligent voice system
31	Skylight	38	Hotel link system



product introduction



18

18



product Picture



NANXIANG

**SPACE CABIN
ACCOMMODATION
MODULE**



configuration instructions

NANXIANG

SPACE CABIN ACCOMMODATION MODULE

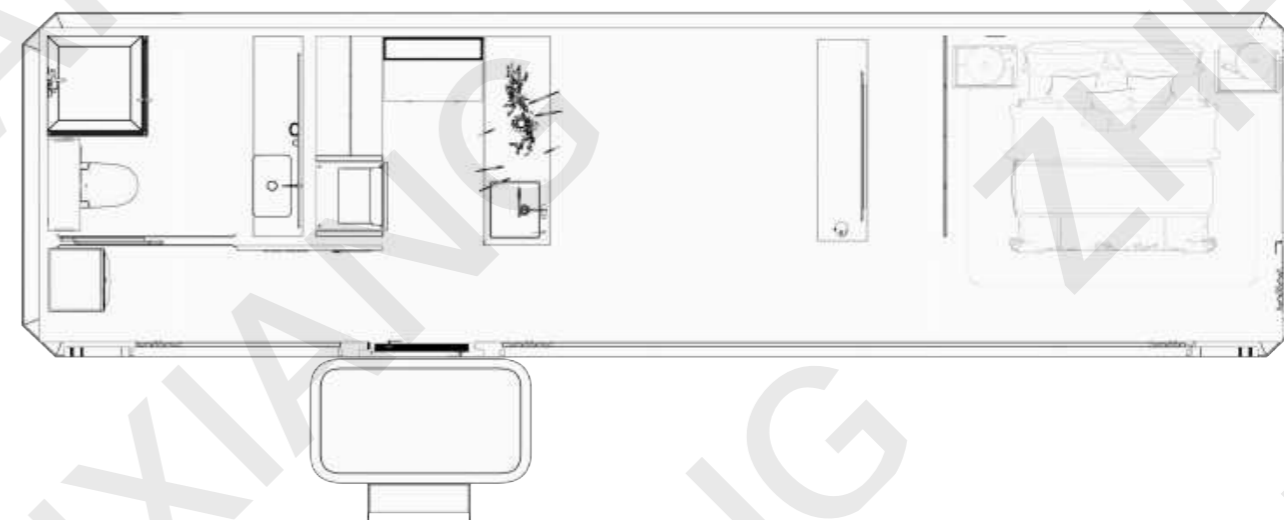

*Subject to The Actual Product

Configuration instructions	
Dimensions	12000mm*3000mm*3200mm
Floor Area	29.7m ²
Occupancy	2
Power consumption	12KW
Approximate total weight	8ton

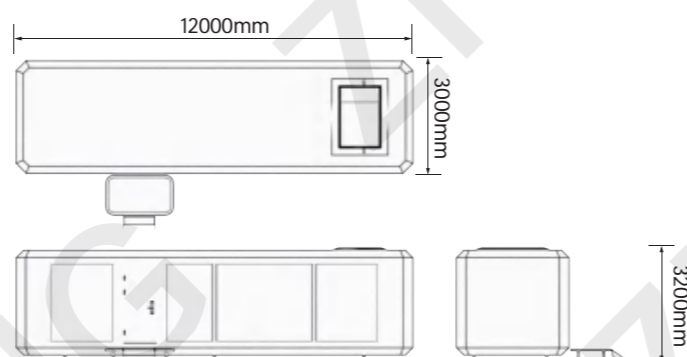

Extracorporeal structure		
No.	Structure	Material
1	Steel structure frame	Steel structure frame
2	Exterior wall panels	Aluminum
3	Heat insulation	100mm polyurethane insulation layer
4	External wall glass	6+18A+6 hollow LOW-E glass or 6+6 amine insulating glass
5	Shell surface treatment	Metal fluorocarbon paint baking paint
6	Balcony	Panoramic balcony (10mm tempered glass)
7	Peripheral light strip	Peripheral light strip (surrounding ambient light strip)
8	Entrance door	Intelligent access control system

Eco-friendly fine decoration inside Structural materials		
No.	Structure	Material
9	Ceiling	Can be decorated with integrated board
10	Wall surface	Can be decorated with integrated board
11	Floor	High-grade wood grain lock floor
12	Indoor lighting effect	3000K warm yellow light
13	Outdoor lighting effect	4000K warm white light
14	Control system	The whole house integrated intelligent control system
15	Socket panel	Brand switch panel

Whole house equipment		
No.	Structure	Material
16	Air conditioner	Ducted air conditioner
17	Yuba	Air-heated three-in-one integrated bathroom

configuration instructions

NANXIANG

SPACE CABIN ACCOMMODATION MODULE

Bathroom Fittings		
No.	Structure	Material
18	Bathroom privacy door	Frosted tempered glass
19	Hanger Towel Rack	Hanger Towel Rack
20	Shower	50L bucket water heater
21	Basin	Above counter basin
22	Toilet	Smart toilet
23	Faucet	Tall faucet

Other Accessories	
No.	Structure
24	Shipping Fixtures/Connectors

Optional accessories			
No.	Structure	No.	Structure
25	Curtain	32	Circulation ventilation system
26	Electric curtain	33	Security alarm: smoke
27	Plug in card power/take card power	34	Multi-scene mode function panel
28	Floor heating: Electric floor heating	35	Intelligent lighting control
29	Pipeline antifreeze: electric heat tracing	36	Intelligent curtain control
30	Audio-visual equipment: Projector	37	Intelligent voice system
31	Skylight	38	Hotel link system



product introduction

Y90

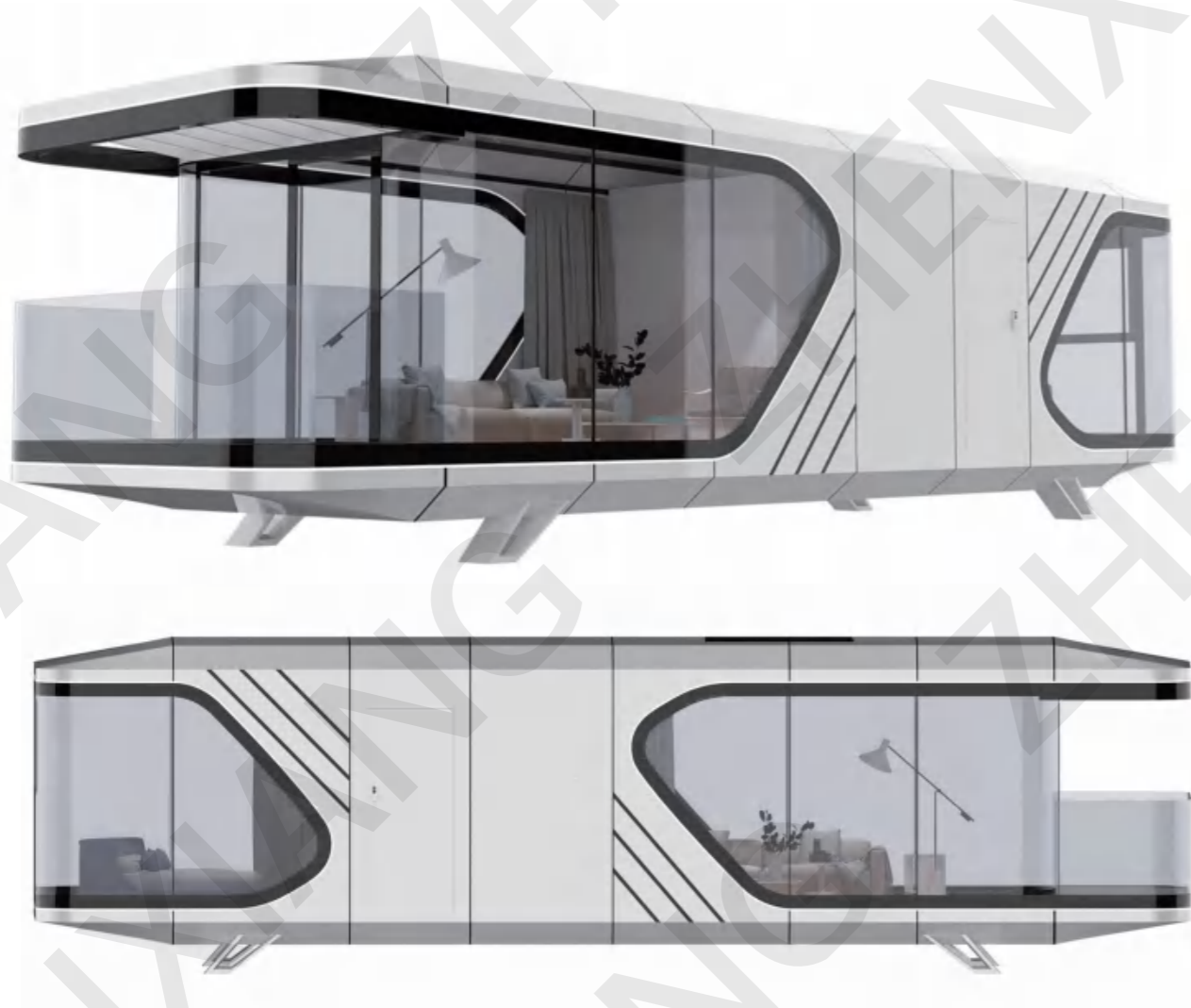

*Subject to The Actual Product

Configuration instructions	
Dimensions	12000mm*3300mm*3400mm
Occupancy	2
Power consumption	10KW
Approximate total weight	10ton

ZHENXIANG

SPACE CABIN ACCOMMODATION MODULE

Extracorporeal structure		
No.	Structure	Material
1	Steel structure frame	Steel structure frame
2	Exterior wall panels	Aluminum
3	Heat insulation	100mm polyurethane insulation layer
4	External wall glass	6+12A+6 hollow LOW-E glass or 6+6 amine insulating glass
5	Shell surface treatment	Metal fluorocarbon paint baking paint
6	Balcony	Panoramic balcony (10mm tempered glass)
7	Peripheral light strip	Peripheral light strip (surrounding ambient light strip)
8	Entrance door	Intelligent access control system

Eco-friendly fine decoration inside Structural materials		
No.	Structure	Material
9	Ceiling	Can be decorated with integrated board
10	Wall surface	Can be decorated with integrated board
11	Floor	High-grade wood grain lock floor
12	Indoor lighting effect	3000K warm yellow light
13	Outdoor lighting effect	4000K warm white light
14	Control system	The whole house integrated intelligent control system
15	Socket panel	Brand switch panel

Whole house equipment		
No.	Structure	Material
16	Air conditioner	Ducted air conditioner
17	Yuba	Air-heated three-in-one integrated bathroom

product introduction

ZHENXIANG

SPACE CABIN ACCOMMODATION MODULE

Bathroom Fittings		
No.	Structure	Material
18	Bathroom privacy door	Frosted tempered glass
19	Hanger Towel Rack	Hanger Towel Rack
20	Shower	50L bucket water heater
21	Basin	Above counter basin
22	Toilet	Smart toilet
23	Faucet	Tall faucet

Other Accessories	
No.	Structure
24	Shipping Fixtures/Connectors

Optional accessories			
No.	Structure	No.	Structure
25	Curtain	32	Circulation ventilation system
26	Electric curtain	33	Security alarm: smoke
27	Plug in card power/take card power	34	Multi-scene mode function panel
28	Floor heating: Electric floor heating	35	Intelligent lighting control
29	Pipeline antifreeze: electric heat tracing	36	Intelligent curtain control
30	Audio-visual equipment: Projector	37	Intelligent voice system
31	Skylight	38	Hotel link system



PRODUCT INTRODUCTION

ZHENXIANG

SPACE CABIN ACCOMMODATION MODULE



PRODUCT INTRODUCTION

ZHENXIANG

SPACE CABIN ACCOMMODATION MODULE



product introduction

Y60



*Subject to The Actual Product

Configuration instructions	
Dimensions	10000mm*3300mm*3400mm
Occupancy	2
Power consumption	9KW
Approximate total weight	8ton

ZHENXIANG

SPACE CABIN ACCOMMODATION MODULE

Extracorporeal structure		
No.	Structure	Material
1	Steel structure frame	Steel structure frame
2	Exterior wall panels	Aluminum
3	Heat insulation	100mm polyurethane insulation layer
4	External wall glass	6+12A+6 hollow LOW-E glass or 6+6 amine insulating glass
5	Shell surface treatment	Metal fluorocarbon paint baking paint
6	Balcony	Panoramic balcony (10mm tempered glass)
7	Peripheral light strip	Peripheral light strip (surrounding ambient light strip)
8	Entrance door	Intelligent access control system

Eco-friendly fine decoration inside Structural materials		
No.	Structure	Material
9	Ceiling	Can be decorated with integrated board
10	Wall surface	Can be decorated with integrated board
11	Floor	High-grade wood grain lock floor
12	Indoor lighting effect	3000K warm yellow light
13	Outdoor lighting effect	4000K warm white light
14	Control system	The whole house integrated intelligent control system
15	Socket panel	Brand switch panel

Whole house equipment		
No.	Structure	Material
16	Air conditioner	Ducted air conditioner
17	Yuba	Air-heated three-in-one integrated bathroom

product introduction

ZHENXIANG

SPACE CABIN ACCOMMODATION MODULE

Bathroom Fittings		
No.	Structure	Material
18	Bathroom privacy door	Frosted tempered glass
19	Hanger Towel Rack	Hanger Towel Rack
20	Shower	50L bucket water heater
21	Basin	Above counter basin
22	Toilet	Smart toilet
23	Faucet	Tall faucet

Other Accessories	
No.	Structure
24	Shipping Fixtures/Connectors

Optional accessories			
No.	Structure	No.	Structure
25	Curtain	32	Circulation ventilation system
26	Electric curtain	33	Security alarm: smoke
27	Plug in card power/take card power	34	Multi-scene mode function panel
28	Floor heating: Electric floor heating	35	Intelligent lighting control
29	Pipeline antifreeze: electric heat tracing	36	Intelligent curtain control
30	Audio-visual equipment: Projector	37	Intelligent voice system
31	Skylight	38	Hotel link system



PRODUCT INTRODUCTION

ZHENXIANG

SPACE CABIN ACCOMMODATION MODULE



PRODUCT INTRODUCTION

ZHENXIANG

SPACE CABIN ACCOMMODATION MODULE



product introduction



Y30

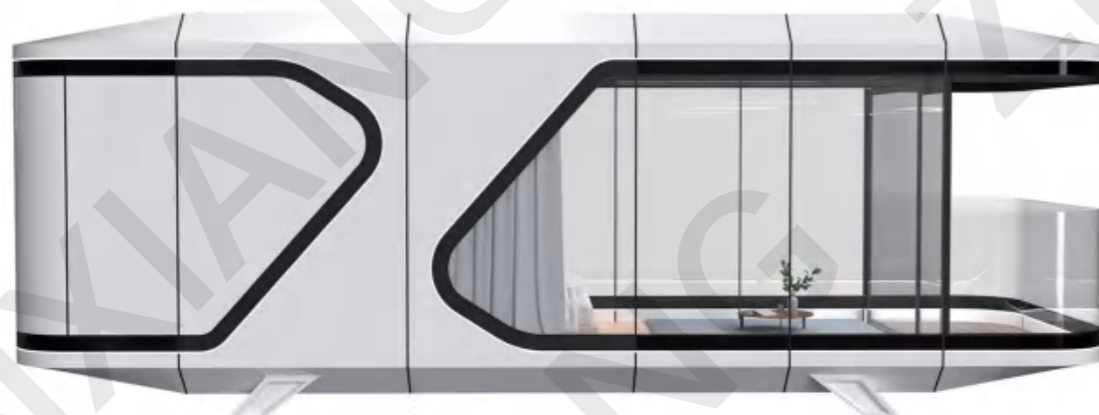
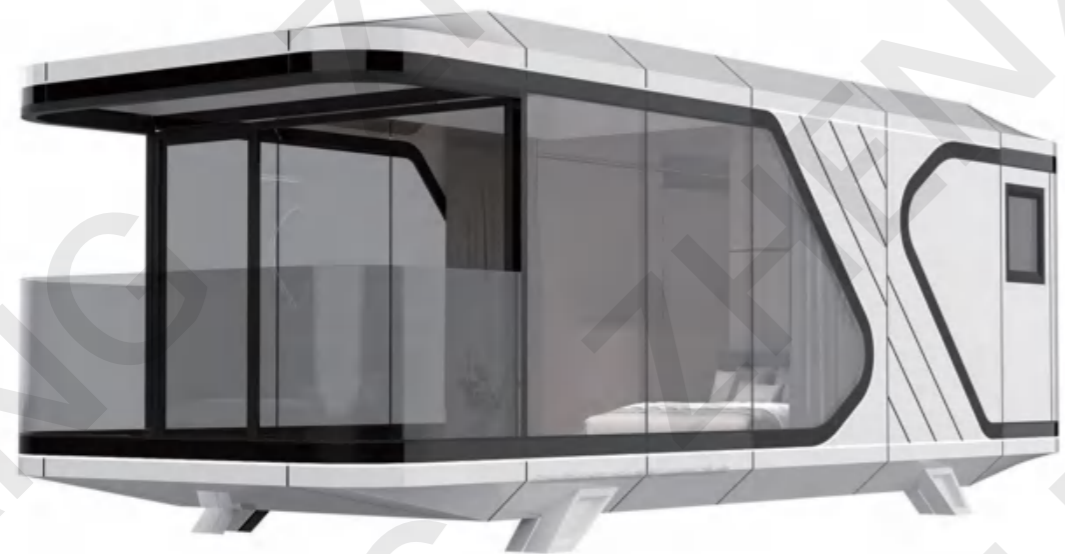

*Subject to The Actual Product

Configuration instructions	
Dimensions	9000mm*3300mm*3400mm
Occupancy	2
Power consumption	9KW
Approximate total weight	8ton

ZHENXIANG

SPACE CABIN ACCOMMODATION MODULE

Extracorporeal structure		
No.	Structure	Material
1	Steel structure frame	Steel structure frame
2	Exterior wall panels	Aluminum
3	Heat insulation	100mm polyurethane insulation layer
4	External wall glass	6+12A+6 hollow LOW-E glass or 6+6 amine insulating glass
5	Shell surface treatment	Metal fluorocarbon paint baking paint
6	Balcony	Panoramic balcony (10mm tempered glass)
7	Peripheral light strip	Peripheral light strip (surrounding ambient light strip)
8	Entrance door	Intelligent access control system

Eco-friendly fine decoration inside Structural materials		
No.	Structure	Material
9	Ceiling	Can be decorated with integrated board
10	Wall surface	Can be decorated with integrated board
11	Floor	High-grade wood grain lock floor
12	Indoor lighting effect	3000K warm yellow light
13	Outdoor lighting effect	4000K warm white light
14	Control system	The whole house integrated intelligent control system
15	Socket panel	Brand switch panel

Whole house equipment		
No.	Structure	Material
16	Air conditioner	Ducted air conditioner
17	Yuba	Air-heated three-in-one integrated bathroom

product introduction

ZHENXIANG

SPACE CABIN ACCOMMODATION MODULE

Bathroom Fittings		
No.	Structure	Material
18	Bathroom privacy door	Frosted tempered glass
19	Hanger Towel Rack	Hanger Towel Rack
20	Shower	50L bucket water heater
21	Basin	Above counter basin
22	Toilet	Smart toilet
23	Faucet	Tall faucet

Other Accessories	
No.	Structure
24	Shipping Fixtures/Connectors

Optional accessories			
No.	Structure	No.	Structure
25	Curtain	32	Circulation ventilation system
26	Electric curtain	33	Security alarm: smoke
27	Plug in card power/take card power	34	Multi-scene mode function panel
28	Floor heating: Electric floor heating	35	Intelligent lighting control
29	Pipeline antifreeze: electric heat tracing	36	Intelligent curtain control
30	Audio-visual equipment: Projector	37	Intelligent voice system
31	Skylight	38	Hotel link system



PRODUCT INTRODUCTION

ZHENXIANG

SPACE CABIN ACCOMMODATION MODULE



PRODUCT INTRODUCTION

ZHENXIANG

SPACE CABIN ACCOMMODATION MODULE



product introduction



Y10

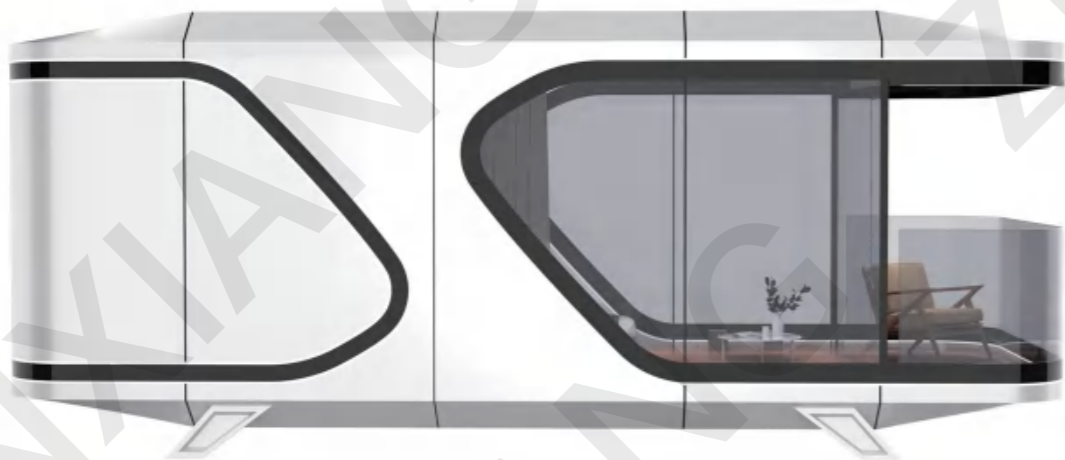

*Subject to The Actual Product

Configuration instructions	
Dimensions	7920mm*3300mm*3400mm
Occupancy	2
Power consumption	9KW
Approximate total weight	6ton

ZHENXIANG

SPACE CABIN ACCOMMODATION MODULE

Extracorporeal structure		
No.	Structure	Material
1	Steel structure frame	Steel structure frame
2	Exterior wall panels	Aluminum
3	Heat insulation	100mm polyurethane insulation layer
4	External wall glass	6+12A+6 hollow LOW-E glass or 6+6 amine insulating glass
5	Shell surface treatment	Metal fluorocarbon paint baking paint
6	Balcony	Panoramic balcony (10mm tempered glass)
7	Peripheral light strip	Peripheral light strip (surrounding ambient light strip)
8	Entrance door	Intelligent access control system

Eco-friendly fine decoration inside Structural materials		
No.	Structure	Material
9	Ceiling	Can be decorated with integrated board
10	Wall surface	Can be decorated with integrated board
11	Floor	High-grade wood grain lock floor
12	Indoor lighting effect	3000K warm yellow light
13	Outdoor lighting effect	4000K warm white light
14	Control system	The whole house integrated intelligent control system
15	Socket panel	Brand switch panel

Whole house equipment		
No.	Structure	Material
16	Air conditioner	Ducted air conditioner
17	Yuba	Air-heated three-in-one integrated bathroom

product introduction

ZHENXIANG

SPACE CABIN ACCOMMODATION MODULE

Bathroom Fittings		
No.	Structure	Material
18	Bathroom privacy door	Frosted tempered glass
19	Hanger Towel Rack	Hanger Towel Rack
20	Shower	50L bucket water heater
21	Basin	Above counter basin
22	Toilet	Smart toilet
23	Faucet	Tall faucet

Other Accessories	
No.	Structure
24	Shipping Fixtures/Connectors

Optional accessories			
No.	Structure	No.	Structure
25	Curtain	32	Circulation ventilation system
26	Electric curtain	33	Security alarm: smoke
27	Plug in card power/take card power	34	Multi-scene mode function panel
28	Floor heating: Electric floor heating	35	Intelligent lighting control
29	Pipeline antifreeze: electric heat tracing	36	Intelligent curtain control
30	Audio-visual equipment: Projector	37	Intelligent voice system
31	Skylight	38	Hotel link system



PRODUCT INTRODUCTION

ZHENXIANG

SPACE CABIN ACCOMMODATION MODULE



PRODUCT INTRODUCTION

ZHENXIANG

SPACE CABIN ACCOMMODATION MODULE



product introduction

c90

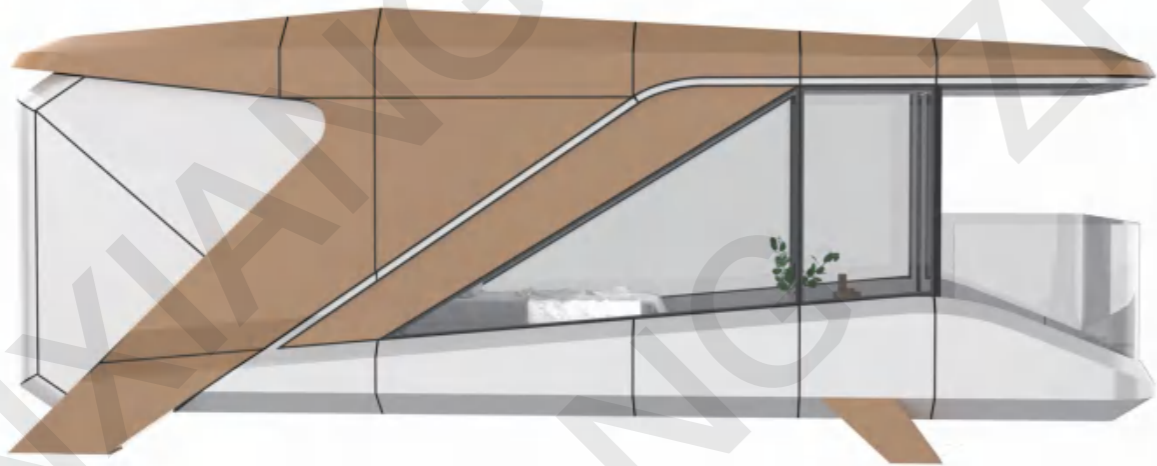
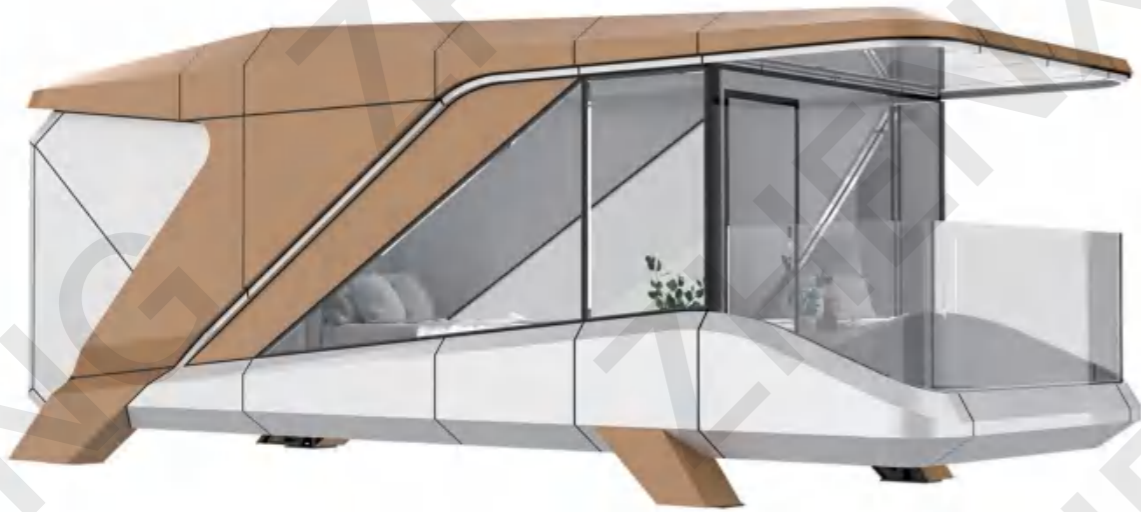

*Subject to The Actual Product

Configuration instructions	
Dimensions	9000mm*3300mm*3500mm
Occupancy	2
Power consumption	9KW
Approximate total weight	8ton

ZHENXIANG

SPACE CABIN ACCOMMODATION MODULE

Extracorporeal structure		
No.	Structure	Material
1	Steel structure frame	Steel structure frame
2	Exterior wall panels	Aluminum
3	Heat insulation	100mm polyurethane insulation layer
4	External wall glass	6+12A+6 hollow LOW-E glass or 6+6 amine insulating glass
5	Shell surface treatment	Metal fluorocarbon paint baking paint
6	Balcony	Panoramic balcony (10mm tempered glass)
7	Peripheral light strip	Peripheral light strip (surrounding ambient light strip)
8	Entrance door	Intelligent access control system

Eco-friendly fine decoration inside Structural materials		
No.	Structure	Material
9	Ceiling	Can be decorated with integrated board
10	Wall surface	Can be decorated with integrated board
11	Floor	High-grade wood grain lock floor
12	Indoor lighting effect	3000K warm yellow light
13	Outdoor lighting effect	4000K warm white light
14	Control system	The whole house integrated intelligent control system
15	Socket panel	Brand switch panel

Whole house equipment		
No.	Structure	Material
16	Air conditioner	Ducted air conditioner
17	Yuba	Air-heated three-in-one integrated bathroom

product introduction

ZHENXIANG

SPACE CABIN ACCOMMODATION MODULE

Bathroom Fittings		
No.	Structure	Material
18	Bathroom privacy door	Frosted tempered glass
19	Hanger Towel Rack	Hanger Towel Rack
20	Shower	50L bucket water heater
21	Basin	Above counter basin
22	Toilet	Smart toilet
23	Faucet	Tall faucet

Other Accessories	
No.	Structure
24	Shipping Fixtures/Connectors

Optional accessories			
No.	Structure	No.	Structure
25	Curtain	32	Circulation ventilation system
26	Electric curtain	33	Security alarm: smoke
27	Plug in card power/take card power	34	Multi-scene mode function panel
28	Floor heating: Electric floor heating	35	Intelligent lighting control
29	Pipeline antifreeze: electric heat tracing	36	Intelligent curtain control
30	Audio-visual equipment: Projector	37	Intelligent voice system
31	Skylight	38	Hotel link system



PRODUCT INTRODUCTION

ZHENXIANG

SPACE CABIN ACCOMMODATION MODULE



PRODUCT INTRODUCTION

ZHENXIANG

SPACE CABIN ACCOMMODATION MODULE



product introduction



d80

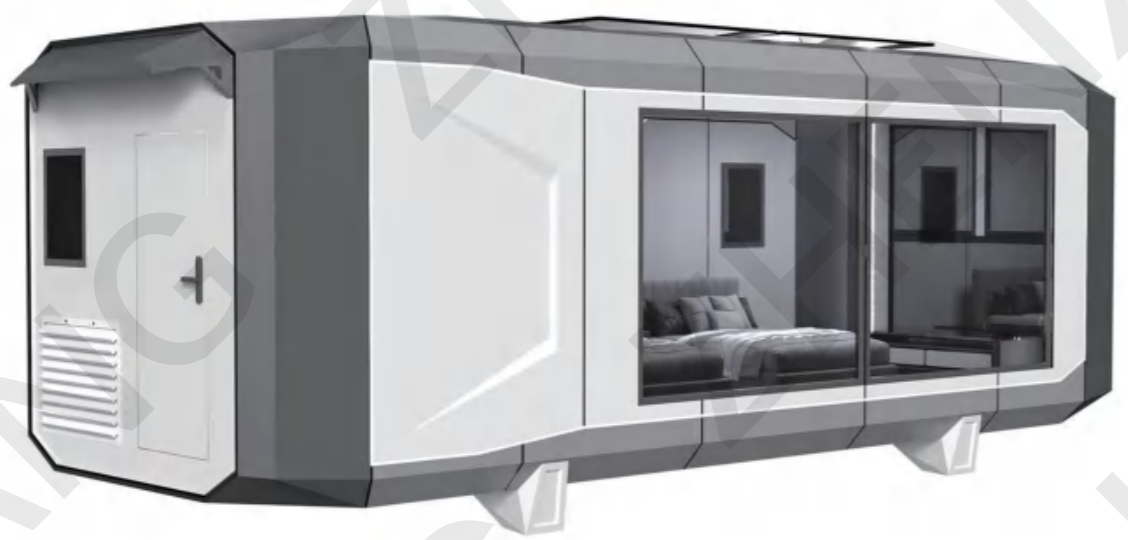

*Subject to The Actual Product

Configuration instructions	
Dimensions	9320mm*3300mm*3500mm
Occupancy	2
Power consumption	9KW
Approximate total weight	8ton

ZHENXIANG

SPACE CABIN ACCOMMODATION MODULE

Extracorporeal structure		
No.	Structure	Material
1	Steel structure frame	Steel structure frame
2	Exterior wall panels	Aluminum
3	Heat insulation	100mm polyurethane insulation layer
4	External wall glass	6+12A+6 hollow LOW-E glass or 6+6 amine insulating glass
5	Shell surface treatment	Metal fluorocarbon paint baking paint
6	Balcony	Panoramic balcony (10mm tempered glass)
7	Peripheral light strip	Peripheral light strip (surrounding ambient light strip)
8	Entrance door	Intelligent access control system

Eco-friendly fine decoration inside Structural materials		
No.	Structure	Material
9	Ceiling	Can be decorated with integrated board
10	Wall surface	Can be decorated with integrated board
11	Floor	High-grade wood grain lock floor
12	Indoor lighting effect	3000K warm yellow light
13	Outdoor lighting effect	4000K warm white light
14	Control system	The whole house integrated intelligent control system
15	Socket panel	Brand switch panel

Whole house equipment		
No.	Structure	Material
16	Air conditioner	Ducted air conditioner
17	Yuba	Air-heated three-in-one integrated bathroom

product introduction

ZHENXIANG

SPACE CABIN ACCOMMODATION MODULE

Bathroom Fittings		
No.	Structure	Material
18	Bathroom privacy door	Frosted tempered glass
19	Hanger Towel Rack	Hanger Towel Rack
20	Shower	50L bucket water heater
21	Basin	Above counter basin
22	Toilet	Smart toilet
23	Faucet	Tall faucet

Other Accessories	
No.	Structure
24	Shipping Fixtures/Connectors

Optional accessories			
No.	Structure	No.	Structure
25	Curtain	32	Circulation ventilation system
26	Electric curtain	33	Security alarm: smoke
27	Plug in card power/take card power	34	Multi-scene mode function panel
28	Floor heating: Electric floor heating	35	Intelligent lighting control
29	Pipeline antifreeze: electric heat tracing	36	Intelligent curtain control
30	Audio-visual equipment: Projector	37	Intelligent voice system
31	Skylight	38	Hotel link system



product introduction

ZHENXIANG

SPACE CABIN ACCOMMODATION MODULE

a60

a50



*Subject to The Actual Product

*Subject to The Actual Product

Configuration instructions	
Dimensions	8500mm*3360mm*3300mm
Occupancy	2
Power consumption	9KW
Approximate total weight	8ton

Configuration instructions	
Dimensions	10000mm*3300mm*3040mm
Occupancy	2
Power consumption	9KW
Approximate total weight	10ton

product introduction



a30



*Subject to The Actual Product

Configuration instructions	
Dimensions	8000mm*3500mm*3040mm
Occupancy	2
Power consumption	10KW
Approximate total weight	10ton

ZHENXIANG

SPACE CABIN ACCOMMODATION MODULE

