

YIY

AVR

VOLTAGE REGULATOR
SERVO TYPE / RELAY TYPE /
IGBT TYPE / OTHERS

Start Digital Power Supply



ZHEJIANG YIYEN HOLDING GROUP

ZHEJIANG YIYEN HOLDING GROUP is a high-tech company that focuses on researching and manufacturing power electronic technology, integrating design, research and development, manufacturing, sales and service. YIYEN is dedicated to reducing electricity costs, improving electricity efficiency, and providing core power equipment and system solutions for the energy Internet of Things. With electrochemical energy storage and energy efficiency management as its core industry, YIYEN provides energy-saving service for power system, communication system, financial system, education system, medical system, and large industrial and mining enterprises.

Energy storage and energy efficiency management are critical reducing carbon emissions and promoting sustainable development. YIYEN's mission is to help make energy and ecology more harmonious by providing advanced energy storage and power quality solutions which improve efficiency, reduce costs, and promote clean energy. YIYEN will always continue to devote ourselves to the research and development and manufacturing of power electronic technology, and be committed to delivering cutting-edge solutions helping customers meet their energy management goals while contributing to a more sustainable future for all.

300+
Staff



30000m²+
Plant Area



15 year +
Years Experience



100,000+ /year
Unit Shipments



ENTERPRISE ARCHITECTURE



Headquarters

ZHEJIANG YIYEN HOLDING GROUP



Intelligent
Manufacturing

Lishui Yiyen Technology
CO.,LTD



Factory



Globalization
Channel

Wenzhou Yiyen Supply Chain
Management CO.,LTD



Marketing/Sales/Sourcing
Total Solutions and Technical Services



Investment
Operation

Wenzhou Yiyen Energy
Development CO.,LTD



EPC Service Provider for New Energy and
Energy Storage Plants
Contract Energy Management
(Domestic Only)



R&D

Nanjing Branch
Shenzhen Branch
Hangzhou Branch



R&D Center

50+

R&D Staff



130+

Export Countries



100+

Intellectual Properties



Qualification Certification

ISO9001



QUALITY MANAGEMENT SYSTEM CERTIFICATE

Certificate No. : 2022Q21193R0S

We hereby certify that the organization:
LISHUI YIYEN TECHNOLOGY COMPANY LIMITED
Unified social credit code: 91331127MA2E079Y8T

is in conformity with Quality Management System Standard:
GB/T19001-2016 idt ISO9001:2015

The certificate is valid to the following products/service:

The assembling of Voltage Stabilizer, Inverter, Photovoltaic Equipment (MPPT Solar Charger, PCS), Uninterruptible Power Supply, Emergency Power Supply, Battery Pack Energy Storage System, Battery Management System (BMS)

Registration Address/Audit Address: No.77,Xiang Long Road,Lian Du Zone,Lishui City,Zhejiang Province, China.

Date of Issue: 26-09-2022
Date of Expiry: 25-09-2025
Date of Initial: 26-09-2022

Issued By: 



中国认可
国际互认
管理体系
MANAGEMENT SYSTEM
CNAS C197-M



The audit of validity of the certificate, the certificate shall be at least once a year.
The effectiveness of the Certificate is subject to QR Code in the lower left corner.
Meanwhile, you can search the website of certification body: www.qpc.org.cn
or search the CNCA website: www.cnca.gov.cn

ZHEJIANG QUANPIN CERTIFICATION CO.,LTD.
Room 603, Floor 6, Building 1, No.74, Puyan Road, Puyan Street, Binjiang District, Hangzhou City,
Zhejiang Province, China 310053 WEB: <http://www.qpc.org.cn>

ISO45001



OCCUPATIONAL HEALTH AND SAFETY MANAGEMENT SYSTEM CERTIFICATE

Certificate No. : 2022S20467R0S

We hereby certify that the organization:
LISHUI YIYEN TECHNOLOGY COMPANY LIMITED
Unified social credit code: 91331127MA2E079Y8T

is in conformity with Occupational Health Safety Management System Standard:
GB/T45001-2020 idt ISO45001:2018

The certificate is valid to the following products/service:

The assembly and related management activities of Voltage Stabilizer, Inverter, Photovoltaic Equipment (MPPT Solar Charger, PCS), Uninterruptible Power Supply, Emergency Power Supply, Battery Pack Energy Storage System, Battery Management System (BMS)

Registration Address/Audit Address: No.77,Xiang Long Road,Lian Du Zone,Lishui City,Zhejiang Province, China.

Date of Issue: 26-09-2022
Date of Expiry: 25-09-2025
Date of Initial: 26-09-2022

Issued By: 



中国认可
国际互认
管理体系
MANAGEMENT SYSTEM
CNAS C197-M



The audit of validity of the certificate, the certificate shall be at least once a year.
The effectiveness of the Certificate is subject to QR Code in the lower left corner.
Meanwhile, you can search the website of certification body: www.qpc.org.cn
or search the CNCA website: www.cnca.gov.cn

ZHEJIANG QUANPIN CERTIFICATION CO.,LTD.
Room 603, Floor 6, Building 1, No.74, Puyan Road, Puyan Street, Binjiang District, Hangzhou City,
Zhejiang Province, China 310053 WEB: <http://www.qpc.org.cn>

ISO14001



ENVIRONMENTAL MANAGEMENT SYSTEM CERTIFICATE

Certificate No. : 2022E20495R0S

We hereby certify that the organization:
LISHUI YIYEN TECHNOLOGY COMPANY LIMITED
Unified social credit code: 91331127MA2E079Y8T

is in conformity with Environmental Management System Standard:
GB/T24001-2016 idt ISO14001:2015

The certificate is valid to the following products/service:

The assembly and related management activities of Voltage Stabilizer, Inverter, Photovoltaic Equipment (MPPT Solar Charger, PCS), Uninterruptible Power Supply, Emergency Power Supply, Battery Pack Energy Storage System, Battery Management System (BMS)

Registration Address/Audit Address: No.77,Xiang Long Road,Lian Du Zone,Lishui City,Zhejiang Province, China.

Date of Issue: 26-09-2022
Date of Expiry: 25-09-2025
Date of Initial: 26-09-2022

Issued By: 



中国认可
国际互认
管理体系
MANAGEMENT SYSTEM
CNAS C197-M



The audit of validity of the certificate, the certificate shall be at least once a year.
The effectiveness of the Certificate is subject to QR Code in the lower left corner.
Meanwhile, you can search the website of certification body: www.qpc.org.cn
or search the CNCA website: www.cnca.gov.cn

ZHEJIANG QUANPIN CERTIFICATION CO.,LTD.
Room 603, Floor 6, Building 1, No.74, Puyan Road, Puyan Street, Binjiang District, Hangzhou City,
Zhejiang Province, China 310053 WEB: <http://www.qpc.org.cn>

KES TESTING CERTIFICATION

Certificate of Conformity



Certification No.: KESJC2022091465
Applicant: LISHUI YIYEN TECHNOLOGY COMPANY LIMITED
Address: No.77,Xiang Long Road,Lian Du Zone,Lishui City,Zhejiang Province, China.
Manufacturer: LISHUI YIYEN TECHNOLOGY COMPANY LIMITED
Address: No.77,Xiang Long Road,Lian Du Zone,Lishui City,Zhejiang Province, China.
Certification: CE-LVD
Product Description: Three phase automatic compensation voltage regulator
 SBW-30kVA, SBW-50kVA, SBW-60kVA, SBW-80kVA, SBW-100kVA, SBW-120kVA, SBW-150kVA, SBW-180kVA, SBW-200kVA, SBW-220kVA, SBW-250kVA, SBW-300kVA, SBW-320kVA, SBW-350kVA, SBW-400kVA, SBW-500kVA, SBW-600kVA, SBW-800kVA, SBW-1000kVA, SBW-1200kVA, SBW-1500kVA, SBW-1600kVA, SBW-2000kVA, SBW-2500kVA
Model:
Trademark: N/A
 The above products have been tested by us with listed standards and found in compliance with the Directive 2014/53/EU. It is possible to use CE marking to demonstrate the compliance with the Directive.
Test Standards: EN 62368-1:2020+A11:2020

The certificate is based on a single evaluation of tested samples of above-mentioned product. It does not imply an assessment of the whole production and does not permit the use of the test lab. logo.



Authorized Signer:
 Li Manager
 16.10.2022

Shenzhen KES Testing & Certification Co., LTD
 Room 405, Floor 4th, Building C, Nanshan Technology Industrial Park, Nanshan Street, East An District, Shenzhen, Guangdong, China
 86-755-23009643 86-755-23009643 http://www.kes-test.com

Certificate of Conformity

NO.: ES170318188E

The following product has been tested by us with the listed standards and found in conformity with the council EMC directive 2014/53/EU. It is possible to use CE marking to demonstrate the conformity with this EMC Directive.
Applicant: YUEQING YIYEN ELECTRIC TECHNOLOGY COMPANY LIMITED
Address: 4th Floor, No.281,Wei 18 Road, Economic Development Zone, Yueqing City, 325600, Zhejiang Province, China
Manufacturer: Shenzhen Yiyuan Technology Co., Ltd
Address: 4th Floor, Building A, Guanghao Industrial Zone, Queshan Road, Longhua Town, Baoan District, Shenzhen City, 518109, China
Trade Mark: YIY
EUT: Automatic Voltage Regulator
MN: SVR-500VA, SVR-1000VA, SVR-1500VA, SVR-2000VA, SVR-3000VA, SVR-5000VA, SVR-8000VA, SVR-10KVA, SVR-15KVA, SVR-20KVA, SVR-30KVA
Test Standards: EN 61000-6-3:2007+A1:2011+AC:2012
 EN 61000-3-12:2011
 EN 61000-3-11:2000
 EN 61000-6-1:2007

The certificate is based on a single evaluation of one sample of above-mentioned products. It does not imply an assessment of the whole production and does not permit the use of the test lab. logo.



Li Manager
 16.10.2022

Ver.1.0

Certificate of Conformity

NO.: ES170318088

The following product has been tested by us with the listed standards and found in conformity with the council LVD directive 2014/35/EU. It is possible to use CE marking to demonstrate the conformity with this LVD Directive.
Applicant: YUEQING YIYEN ELECTRIC TECHNOLOGY COMPANY LIMITED
Address: 4th Floor, No.281,Wei 18 Road, Economic Development Zone, Yueqing City, 325600, Zhejiang Province, China
Manufacturer: Shenzhen Yiyuan Technology Co., Ltd
Address: 4th Floor, Building A, Guanghao Industrial Zone, Queshan Road, Longhua Town, Baoan District, Shenzhen City, 518109, China
Trade Mark: YIY
EUT: Automatic Voltage Regulator
MN: SVR-500VA, SVR-1000VA, SVR-1500VA, SVR-2000VA, SVR-3000VA, SVR-5000VA, SVR-8000VA, SVR-10KVA, SVR-15KVA, SVR-20KVA, SVR-30KVA
Technical Data: Refer to test report.
Test Standards: EN 61558-2-12:2011

The certificate is based on a single evaluation of one sample of above-mentioned products. It does not imply an assessment of the whole production and does not permit the use of the test lab. logo.



Li Manager
 16.10.2022

Ver.1.0

Certificate of Conformity

NO.: ES170318088

The following product has been tested by us with the listed standards and found in conformity with the council LVD directive 2014/35/EU. It is possible to use CE marking to demonstrate the conformity with this LVD Directive.
Applicant: YUEQING YIYEN ELECTRIC TECHNOLOGY COMPANY LIMITED
Address: 4th Floor, No.281,Wei 18 Road, Economic Development Zone, Yueqing City, 325600, Zhejiang Province, China
Manufacturer: Shenzhen Yiyuan Technology Co., Ltd
Address: 4th Floor, Building A, Guanghao Industrial Zone, Queshan Road, Longhua Town, Baoan District, Shenzhen City, 518109, China
Trade Mark: YIY
EUT: Automatic Voltage Regulator
MN: SVR-500VA, SVR-1000VA, SVR-1500VA, SVR-2000VA, SVR-3000VA, SVR-5000VA, SVR-8000VA, SVR-10KVA, SVR-15KVA, SVR-20KVA, SVR-30KVA
Technical Data: Refer to test report.
Test Standards: EN 61558-2-12:2011

The certificate is based on a single evaluation of one sample of above-mentioned products. It does not imply an assessment of the whole production and does not permit the use of the test lab. logo.



Li Manager
 16.10.2022

Ver.1.0

Certificate of Conformity

NO.: ES170318292E

The following product has been tested by us with the listed standards and found in conformity with the council EMC directive 2014/53/EU. It is possible to use CE marking to demonstrate the conformity with this EMC Directive.
Applicant: YUEQING YIYEN ELECTRIC TECHNOLOGY COMPANY LIMITED
Address: 4th Floor, No.281,Wei 18 Road, Economic Development Zone, Yueqing City, 325600, Zhejiang Province, China
Manufacturer: Shenzhen Yiyuan Technology Co., Ltd
Address: 4th Floor, Building A, Guanghao Industrial Zone, Queshan Road, Longhua Town, Baoan District, Shenzhen City, 518109, China
Trade Mark: YIY
EUT: Automatic Voltage Regulator
MN: TR-500VA, TR-1000VA, TR-1500VA, TR-2000VA, TR-3000VA, TR-5000VA, TR-8000VA, TR-10KVA, TR-12KVA, TR-15KVA
Test Standards: EN 61000-6-3:2007+A1:2011+AC:2012
 EN 61000-3-12:2011
 EN 61000-3-11:2000
 EN 61000-6-1:2007

The certificate is based on a single evaluation of one sample of above-mentioned products. It does not imply an assessment of the whole production and does not permit the use of the test lab. logo.



Li Manager
 16.10.2022

Ver.1.0

Certificate of Conformity

NO.: ES170318292S

The following product has been tested by us with the listed standards and found in conformity with the council LVD directive 2014/35/EU. It is possible to use CE marking to demonstrate the conformity with this LVD Directive.
Applicant: YUEQING YIYEN ELECTRIC TECHNOLOGY COMPANY LIMITED
Address: 4th Floor, No.281,Wei 18 Road, Economic Development Zone, Yueqing City, 325600, Zhejiang Province, China
Manufacturer: Shenzhen Yiyuan Technology Co., Ltd
Address: 4th Floor, Building A, Guanghao Industrial Zone, Queshan Road, Longhua Town, Baoan District, Shenzhen City, 518109, China
Trade Mark: YIY
EUT: Automatic Voltage Regulator
MN: TR-500VA, TR-1000VA, TR-1500VA, TR-2000VA, TR-3000VA, TR-5000VA, TR-8000VA, TR-10KVA, TR-12KVA, TR-15KVA
Technical Data: Refer to test report.
Test Standards: EN 61558-2-12:2011

The certificate is based on a single evaluation of one sample of above-mentioned products. It does not imply an assessment of the whole production and does not permit the use of the test lab. logo.



Li Manager
 16.10.2022

Ver.1.0

Certificate of Conformity

NO.: ES170318288

The following product has been tested by us with the listed standards and found in conformity with the council EMC directive 2014/53/EU. It is possible to use CE marking to demonstrate the conformity with this EMC Directive.
Applicant: YUEQING YIYEN ELECTRIC TECHNOLOGY COMPANY LIMITED
Address: 4th Floor, No.281,Wei 18 Road, Economic Development Zone, Yueqing City, 325600, Zhejiang Province, China
Manufacturer: Shenzhen Yiyuan Technology Co., Ltd
Address: 4th Floor, Building A, Guanghao Industrial Zone, Queshan Road, Longhua Town, Baoan District, Shenzhen City, 518109, China
Trade Mark: YIY
EUT: Automatic Voltage Regulator
MN: TSD-500VA, TSD-1000VA, TSD-1500VA, TSD-2000VA, TSD-3000VA, TSD-5000VA, TSD-8000VA, TSD-10KVA, TSD-12KVA
Test Standards: EN 61000-6-3:2007+A1:2011+AC:2012
 EN 61000-3-12:2011
 EN 61000-3-11:2000
 EN 61000-6-1:2007

The certificate is based on a single evaluation of one sample of above-mentioned products. It does not imply an assessment of the whole production and does not permit the use of the test lab. logo.



Li Manager
 16.10.2022

Ver.1.0

Certificate of Conformity

NO.: ES170318288S

The following product has been tested by us with the listed standards and found in conformity with the council LVD directive 2014/35/EU. It is possible to use CE marking to demonstrate the conformity with this LVD Directive.
Applicant: YUEQING YIYEN ELECTRIC TECHNOLOGY COMPANY LIMITED
Address: 4th Floor, No.281,Wei 18 Road, Economic Development Zone, Yueqing City, 325600, Zhejiang Province, China
Manufacturer: Shenzhen Yiyuan Technology Co., Ltd
Address: 4th Floor, Building A, Guanghao Industrial Zone, Queshan Road, Longhua Town, Baoan District, Shenzhen City, 518109, China
Trade Mark: YIY
EUT: Automatic Voltage Regulator
MN: TSD-500VA, TSD-1000VA, TSD-1500VA, TSD-2000VA, TSD-3000VA, TSD-5000VA, TSD-8000VA, TSD-10KVA, TSD-12KVA
Technical Data: Refer to test report.
Test Standards: EN 61558-2-12:2011

The certificate is based on a single evaluation of one sample of above-mentioned products. It does not imply an assessment of the whole production and does not permit the use of the test lab. logo.



Li Manager
 16.10.2022

Ver.1.0

EMTEK

TEST REPORT

EN 61558-2-12 Safety of power transformers, power supply units and similar Part 12: Particular requirements for constant voltage transformers

Report reference No.: ES170318288
 Tested by (r signature): Agan Guo
 Approved by (r signature): William Guo
 Date of issue: May 25, 2017
 Total number of pages: 12 pages
 Testing Laboratory: EMTEK (SHENZHEN) CO., LTD
 Address: Bldg 69, Majiang Industrial Zone, Nanshan District, Shenzhen City, Guangdong, China.
 Testing location/address: Same as above
 Applicant's name: YUEQING YIYEN ELECTRIC TECHNOLOGY COMPANY LIMITED
 Address: 4th Floor, No.281 Wei 18 Road, Economic Development Zone, Yueqing City, 325600, Zhejiang Province, China
Test specification:
 Standard: EN 61558-2-12:2011
 Site in conjunction with: EN 61558-1:2005+A1:2009
 Test procedure: Compliance with EN 61558-2-12:2011 site in conjunction with EN 61558-1:2005+A1:2009
 Non-standard test method: N/A
Test item description: Automatic Voltage Regulator
Trade Mark: YIY
Manufacturer: Shenzhen Yiyuan Technology Co., Ltd
Address: 4th Floor, Building A, Guanghao Industrial Zone, Queshan Road, Longhua Town, Baoan District, Shenzhen City, 518109, China
Model / Type reference: TSD-500VA, TSD-1000VA, TSD-1500VA, TSD-2000VA, TSD-3000VA, TSD-5000VA, TSD-8000VA, TSD-10KVA, TSD-12KVA
Rating: See the rating labels.

PRODUCT CATALOGUE

Servo Motor Type (220V/380V)

PRO Single Phase	01
PWR Single Phase	05
TSS Wall-mounted Single Phase	07
TWS Wall-mounted Single Phase	10
PRO-3 Three Phase	13
PWR-3 Three Phase	16
SBW/SBW-F Three Phase (Industrial)	19
SBW-F IP54 Independent Phase Control	23

Relay Type

AVR Single Phase	26
TRS Wall-Mounted Single Phase	30
SWR Wall-Mounted Single Phase	33
PR Portable Single Phase	36

IGBT Type

CVCF Voltage and Frequency Stabilisers	38
AVC Active Voltage Conditioner	40

Servo Motor Type (120V/208V)

PWR-LV Single Phase	43
TWS-LV Wall-mounted Single Phase	45
PWR-2 Dual Phase	48
PWR-3-LV Three Phase	50
SBW-F IP54 Independent Phase Control	53

Relay Type (120V/208V)

SWR-LV Wall-Mounted Single Phase	55
---	----

Other Types

ST Step Up & Down Transformer	58
TDGC2/TSGC2 Manual Voltage Regulator	60

PRO

Single Phase Servo Motor Type

500VA-30000VA



Features:

- ◆ MCU control
- ◆ Overload protection(on PCB) $\geq 120\%$
- ◆ Over voltage & Under voltage protection
- ◆ Dual LED display/ Multi display
- ◆ More accurate output precision $\leq 2\%$
- ◆ Themistor,upgraded function to offer more accurate over-heat protection to the device.
- ◆ If fan is not working, the device will cut off the output to avoid over-heat.

• Technical Parameter

Specification		500VA	1000VA	1500VA	2000VA	3000VA	5000VA	
Input	Phase	Single phase						
	Voltage	AC 150V-250V / 100V-250V						
	Frequency	50Hz/60Hz						
Output	Voltage	AC 220V ±3% / customized						
	Capacity	400W	800W	1200W	1600W	2400W	4000W	
	Frequency	50Hz/60Hz						
Protection	Low voltage	184V±4V						
	Over voltage	246V±4V						
	Time Delay	5s / 255s optional						
	Overload/ short circuit	Fuse/MCB						
Packaging	Pcs per Carton	4			2			
	Shipping Wt.(kg)	14.6	18.2	22.8	18.9	23.4	28	
	Package dimensions (mm)	430*250*330	500*240*380		610*257*280	610*365*275	610*425*275	
Efficiency	AC-AC	98%						
Acoustic	Noise level	≤50dB						
Environment	Temperature	-5°C to 40°C						
	Humidity	20% to 90%						

Specification		8000VA	10KVA	12KVA	10KVA (Tower)	15KVA (Tower)	20KVA (Tower)	30KVA (Tower)	
Input	Phase	Single phase							
	Voltage	AC 150V-250V / 100V-250V				AC 176V-250V / 100V-250V			
	Frequency	50Hz/60Hz							
Output	Voltage	AC 220V ±3% / customized							
	Capacity	6400W	8KW	9.6KW	8KW	12KW	16KW	24KW	
	Frequency	50Hz/60Hz							
Protection	Low voltage	184V±4V							
	Over voltage	246V±4V							
	Time Delay	5s / 255s optional							
	Overload/ short circuit	Fuse/MCB							
Packaging	Pcs per Carton	1							
	Shipping Wt.(kg)	23.7	25	27	34.5	54.5	79.2	100	
	Package dimensions (mm)	430*250*330			460*360*290	446*345*630	560*380*775	660*380*775	
Efficiency	AC-AC	98%							
Acoustic	Noise level	≤50dB							
Environment	Temperature	-5°C to 40°C							
	Humidity	20% to 90%							



• Product Appearance

PRO C



500VA



1000VA/1500VA



2000VA



3000VA



5000VA



8000VA/10000VA/12000VA

PRO-E



500VA



1000VA/1500VA



2000VA

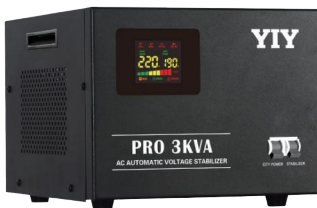

3000VA

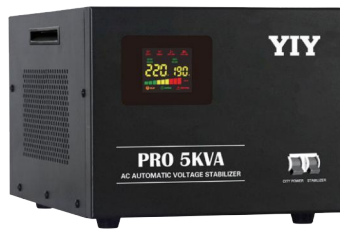

5000VA



8000VA/10000VA/12000VA



• Product Appearance

PRO-E



10000VA

15000VA

20000VA

30000VA

◆ Rear Panel

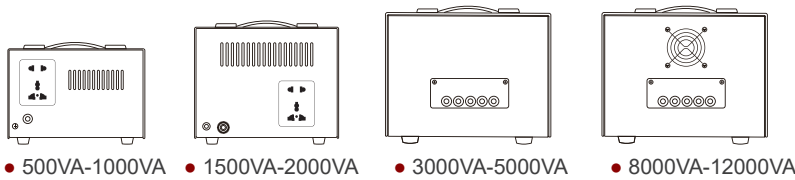

• 500VA-1000VA • 1500VA-2000VA • 3000VA-5000VA • 8000VA-12000VA

◆ Display Options



• A • B • C • D • Dual LED display 1 • LED display • Analog display

◆ Socket Options

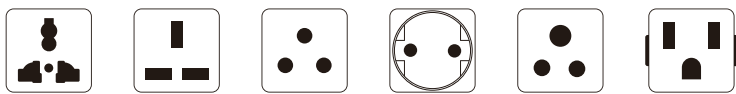

• Universal • UK 13 • UK 15 • European • Indian R6 • US

* More options, please turn to page 42

PWR

Single Phase Servo Motor Type

5KVA-100KVA



Features:

- ◆ Low input voltage
- ◆ More accurate output precision $\leq 2\%$
- ◆ Over voltage & Under voltage protection
- ◆ Themistor, upgraded function to offer more accurate over-heat protection to the device.
- ◆ If fan is not working, the device will cut off the output to avoid over-heat.
- ◆ Overload protection (on PCB) $\geq 120\%$
- ◆ MCU control
- ◆ Multi display
- ◆ Surge protection

• Technical Parameter

Specification		5KVA	10KVA	15KVA	20KVA	30KVA	40KVA	50KVA	75KVA	100KVA
Input	Phase	Single Phase								
	Voltage	AC 160V-280V		AC 165V-275V(±25%)/154V-286V(±30%)						
	Frequency	50Hz/60Hz								
Output	Voltage	AC 220V±3%/230V±3%								
	Capacity	4KW	8KW	12KW	16KW	24KW	32KW	40KW	60KW	80KW
	Frequency	50Hz/60Hz								
Protection	Low Voltage	184±4V/194±4V								
	Over Voltage	246V±4V/256V±4V								
	Time Delay	5s / 255s optional								
	Overload	MCU (cutting off output for 3 seconds when exceeding rated power by 120%)								
	Short Circuit	Circuit Breaker								
	Other	Surge protection								
Efficiency	AC-AC	98%								
Acoustic	Noise level	≤50dB								
Environment	Temperature	-5 C to 40 C								
	Humidity	20% to 90%								

• Product Appearance

PWR



PWR-15K

PWR-20K

PWR-30K

◆ Display Options



• A

• B

• C

• D

TSS

Wall-mounted Single Phase Servo Motor Type

500VA-12000VA



Features:

- ◆ Over voltage & Under voltage protection
- ◆ Reaction time(voltage stabilization time) $\leq 60\text{ms}$
- ◆ High precision: $220\text{VAC} \pm 2\%$
- ◆ Over temperature protection
- ◆ Short delay (5s) & Long delay (255s)

• Technical Parameter

Specification		500VA	1000VA	1500VA	2000VA	3000VA
Input	Phase	Single phase				
	Voltage	AC 100V-260V				
	Frequency	50Hz / 60Hz				
Output	Voltage	AC 220V ±3%				
	Capacity	400W	800W	1200W	1600W	2400W
	Frequency	50Hz / 60Hz				
Protection	Low voltage	184V±4V				
	Over voltage	246V±4V				
	Time Delay	5s / 255s Selectable				
	Overload/ short circuit	Fuse / MCB				
Packaging	Pcs per Carton	4			2	
	Shipping Wt.(kg)	14	18	21.5	17	21
	Package dimensions (mm)	505*415*300		430*320*270		398*315*364
Efficiency	AC-AC	98%				
Acoustic	Noise level	≤50dB				
Environment	Temperature	-5°C to 40°C				
	Humidity	20% to 90%				

Specification		5000VA	8000VA	10KVA	12KVA
Input	Phase	Single phase			
	Voltage	AC 100V-260V			
	Frequency	50Hz / 60Hz			
Output	Voltage	AC 220V ±3%			
	Capacity	4000W	6400W	8KW	9.6KW
	Frequency	50Hz / 60Hz			
Protection	Low voltage	184V±4V			
	Over voltage	246V±4V			
	Time Delay	5s / 255s Selectable			
	Overload/ short circuit	Fuse / MCB			
Packaging	Pcs per Carton	2		1	
	Shipping Wt.(kg)	24	19	22.1	25.1
	Package dimensions (mm)	398*315*364	460*358*225		
Efficiency	AC-AC	98%			
Acoustic	Noise level	≤50dB			
Environment	Temperature	-5°C to 40°C			
	Humidity	20% to 90%			



• Product Appearance



500VA/1000VA

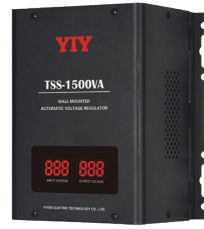

1500VA/1000VA

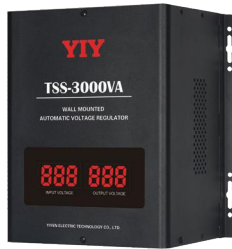

3000VA

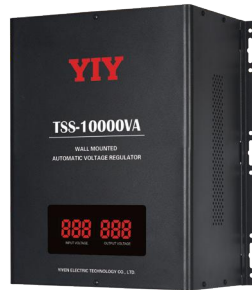

5000VA

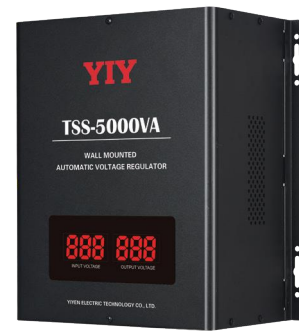

8000VA/10000VA/12000VA

◆ Bottom Panel

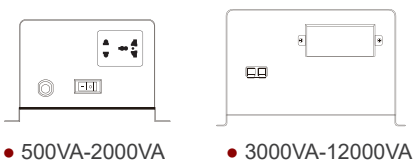

• 500VA-2000VA

• 3000VA-12000VA

◆ Display Options



• A

• B

• C

• D

• Dual LED display • LED display

◆ Socket Options

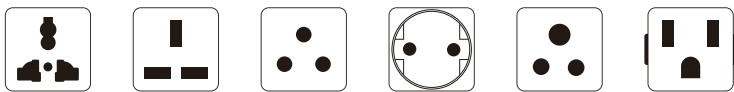

• Universal

• UK 13

• UK 15

• European

• Indian R6

• US

* More options, please turn to page 38

TWS

Wall-mounted Single Phase Servo Motor Type

3KVA-30KVA



Features:

- ◆ Ultra-low input voltage
- ◆ Over voltage & Under voltage protection
- ◆ Reaction time(voltage stabilization time) $\leq 2s$
- ◆ High precision: $220VAC \pm 3\%$
- ◆ Over temperature protection
- ◆ Short delay (5s) & Long delay (255s)

• Technical Parameter

Specification		3000VA	5000VA	10KVA	15KVA	20KVA	30KVA
Input	Phase	Single phase					
	Voltage	AC 80V-260V					
	Frequency	50Hz/60Hz					
Output	Voltage	AC 220V±3%/230V±3%					
	Capacity	2400W	4000W	8KW	12KW	16KW	24KW
	Frequency	50Hz/60Hz					
Protection	Low voltage	184±4V/194±4V					
	Over voltage	246V±4V/256V±4V					
	Time delay	5s (255s optional)					
	Overload	MCU (cutting off output for 3 seconds when exceeding rated power by 120%)					
	Short circuit	Circuit Breaker					
	Other	Surgee protection(optional)					
Product	Dimension	/	340*460*160	340*510*160	540*725*240	540*725*240	540*725*240
Efficiency	AC-AC	98%					
Acoustic	Noise level	≤50dB					
Environment	Temperature	-5℃ to 40℃					
	Humidity	20% to 90%					

• Product Appearance

TWS



TWS-5K



TWS-10K



TWS-15K



TWS-20K



TWS-30K

◆ Bottom Panel

- 5000VA-30000VA

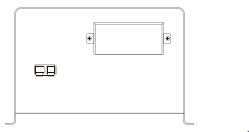

◆ Display Options



• A

• B

• C

• D

PRO-3

Three Phase Servo Motor Type

1.5KVA-100KVA



Features:

- ◆ MCU Control
- ◆ Motor protection (Unique function)
- ◆ More accurate output precision $\leq 2\%$
- ◆ Industrial strength components
- ◆ If fan fails, the device will cut off the output to avoid over-heat
- ◆ Three phase compensation servo motor technology
- ◆ 100% unbalanced loading capability
- ◆ Overload protection (on PCB) $\geq 120\%$
- ◆ Colorful LED display

• Technical Parameter

Specification		1500VA	3000VA	4500VA	6000VA	9000VA	15KVA
Input	Phase	3-phase 4-wire(Can be customized 3-phase 3-wire)					
	Voltage	278V-433V					
	Frequency	50Hz/60Hz					
Output	Voltage	AC 380V ±3%					
	Capacity	1200W	2400W	3600W	4800W	7200W	12KW
	Frequency	50Hz/60Hz					
Protection	Low voltage	318V±7V					
	Over voltage	426V±7V					
	Time Delay	Default 5s					
	Overload/ short circuit	MCB/MCCB/MCU					
Packaging	Pcs per Carton	1					
	Shipping Wt.(kg)	/	/	/	/	/	/
	Package dimensions (mm)	230*330*418			280*380*645		280*380*690
Efficiency	AC-AC	98%					
Acoustic	Noise level	≤50dB					
Environment	Temperature	-5°C to 40°C					
	Humidity	20% to 90%					

Specification		20KVA	30KVA	45KVA	50KVA	60KVA	75KVA	100KVA
Input	Phase	3-phase 4-wire(Can be customized 3-phase 3-wire)						
	Voltage	278V-433V			304V-456V			
	Frequency	50Hz/60Hz						
Output	Voltage	AC 380V ±3%						
	Capacity	16KW	24KW	36KW	40KW	48KW	60KW	80KW
	Frequency	50Hz/60Hz						
Protection	Low voltage	318V±7V						
	Over voltage	426V±7V						
	Time Delay	Default 5s						
	Overload/ short circuit	MCB/MCCB/MCU						
Packaging	Pcs per Carton	1						
	Shipping Wt.(kg)	/	/	/	/	/	/	/
	Package dimensions (mm)	325*420*667			430*755*1020			800*740*1030
Efficiency	AC-AC	98%						
Acoustic	Noise level	≤50dB						
Environment	Temperature	-5°C to 40°C						
	Humidity	20% to 90%						



• Product Appearance

PRO-3

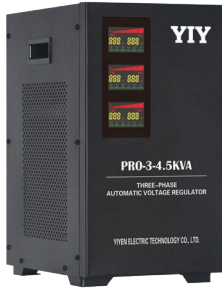

1.5KVA/3KVA/4KVA

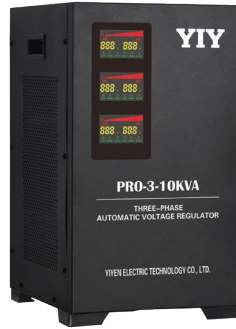

6KVA/9KVA

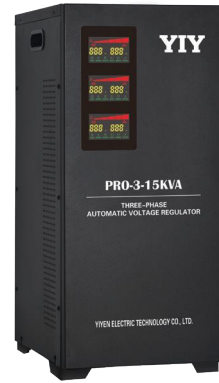

15KVA

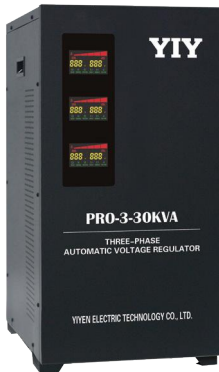

20KVA/30KVA

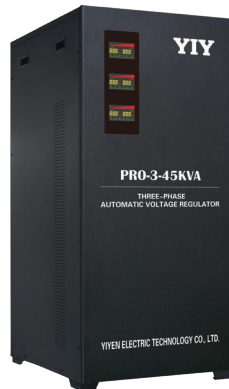

45KVA/50KVA/60KVA/75KVA

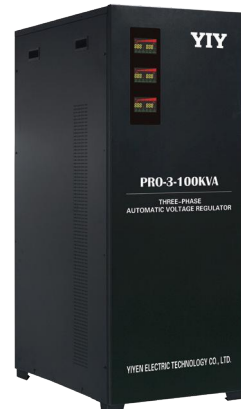

100KVA

◆ Display Options



• LED display

• D

PWR-3

Three Phase Servo Motor Type

15KVA-300KVA

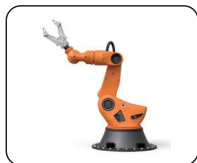

Features:

- ◆ More accurate output precision $\leq 2\%$
- ◆ MCU Control
- ◆ Surge protection
- ◆ Industrial strength components
- ◆ If fan fails, the device will cut off the output to avoid over-heat
- ◆ 100% unbalanced loading capability
- ◆ Ultra-low input voltage
- ◆ Overload protection (on PCB) $\geq 120\%$
- ◆ Multi display

• Technical Parameter

Specification		15KVA	30KVA	45KVA	60KVA	75KVA	100KVA
Input	Phase	3-phase 3-wire					
	Voltage	AC 278V-485V		AC 285V-475V(±25%)/266V-494V(±30%)			
	Frequency	50Hz/60Hz					
Output	Voltage	AC 380V±3%/400V±3%					
	Capacity	12KW	24KW	36KW	48KW	60KW	80KW
	Frequency	50Hz/60Hz					
Protection	Low voltage	318±7V/335±7V					
	Over voltage	425V±7V/442V±7V					
	Time delay	5s					
	Overload	MCU (cutting off output for 3 seconds when exceeding rated power by 120%)					
	Short circuit	Circuit Breaker					
	Other	surge, phase-sequence, phase loss					
Efficiency	AC-AC	98%					
Acoustic	Noise level	≤50dB					
Environment	Temperature	-5°C to 40°C					
	Humidity	20% to 90%					

Specification		120KVA	150KVA	200KVA	250KVA	300KVA
Input	Phase	3-phase 3-wire				
	Voltage	AC 285V-475V(±25%)/266V-494V(±30%)				
	Frequency	50Hz/60Hz				
Output	Voltage	AC 380V±3%/400V±3%				
	Capacity	96KW	120KW	160KW	200KW	240KW
	Frequency	50Hz/60Hz				
Protection	Low voltage	318±7V/335±7V				
	Over voltage	425V±7V/442V±7V				
	Time delay	5s				
	Overload	MCU (cutting off output for 3 seconds when exceeding rated power by 120%)				
	Short circuit	Circuit Breaker				
	Other	surge, phase-sequence, phase loss				
Efficiency	AC-AC	98%				
Acoustic	Noise level	≤50dB				
Environment	Temperature	-5°C to 40°C				
	Humidity	20% to 90%				

• Product Appearance

PWR-3



PWR-3-30KVA



PWR-3-45KVA



PWR-3-60KVA



PWR-3-100KVA

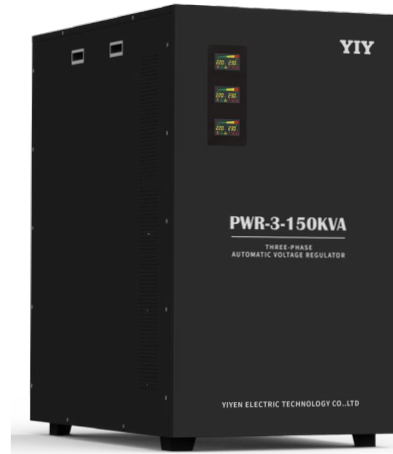

PWR-3-150KVA

◆ Display



• D

SBW/SBW-F

Three Phase Servo Motor Automatic Voltage Regulator

50KVA-3000KVA



SBW/SBW-F Series full automatic three-phase electric voltage regulators with compensator (hereinafter referred to as the voltage regulator) are designed with the advanced European technology and can be customized on various situations of different countries and areas. When the voltage fluctuation happens with the fluctuation of external power grid voltage or load variation, they can keep the stable output voltage automatically. Compared with other types of voltage regulators, SBW series has the advantages, such as the large capacity, high efficiency, no waveform distortion, voltage adjustment stability.

It is applicable for large-sized electromechanical equipment, metal processing equipment, production lines, construction engineering equipment, elevators, medical equipment, light-textile equipment, air conditioners, broadcasting TV, household appliances and lighting in various fields like industry, agriculture, traffic, post & telecommunication, military, railway, scientific research culture, etc.



• Technical Parameter

Specification		50KVA	60KVA	80KVA	100KVA	150KVA	200KVA	250KVA	300KVA	350KVA
Input	Phase	3-phase 4-wire								
	Voltage	AC 304V-456V								
	Frequency	50Hz/60Hz								
Output	Voltage	AC 380V ±3%								
	Capacity	40KW	48KW	64KW	80KW	120KW	160KW	200KW	240KW	280KW
	Frequency	50Hz/60Hz								
Protection	Low voltage	318V ±7V								
	Over voltage	426V±7V								
	Time Delay	3-6s/3-6min optional								
	Overload / short circuit	MCB/MCCB								
Packaging	Pcs per Carton	1								
	Net Wt.(kg)	/	210	/	260	/	430	/	/	/
	Shipping Wt.(kg)	/	220	/	280	/	450	/	/	/
	Package dimensions (mm)	600*750*1330		620*850*1440		750*1000*1750		900*1100*1790		1100*1000*1790
Efficiency	AC-AC	98%								
Acoustic	Noise level	≤50dB								
Environment	Temperature	-15°C to +45°C								
	Humidity	20% to 90%								

Specification		400KVA	500KVA	600KVA	800KVA	1000KVA	1200KVA	1500KVA	3000KVA
Input	Phase	3-phase 4-wire							
	Voltage	AC 304V-456V							
	Frequency	50Hz/60Hz							
Output	Voltage	AC 380V ±3%							
	Capacity	320KW	400KW	480KW	640KW	800KW	960KW	1200KW	2400KW
	Frequency	50Hz/60Hz							
Protection	Low voltage	318V ±7V							
	Over voltage	426V±7V							
	Time delay	3-6s/3-6min optional							
	Overload/ short circuit	MCB/MCCB							
Packaging	Pcs per Carton	1							
	Net Wt.(kg)	740	1050	1090	1835	2335	/	/	/
	Shipping Wt.(kg)	765	1075	1115	1860	2360	/	/	/
	Package dimensions (mm)	1100*1000*1790	1400*1100*2060		(1680*1300*1800)*2			(1680*1300*1800)*3	(1680*1300*1800)*6
Efficiency	AC-AC	98%							
Acoustic	Noise level	≤50dB							
Environment	Temperature	-15°C to +45°C							
	Humidity	20% to 90%							

• Product Appearance

SBW/SBW-F



50KVA~300KVA



350KVA~600KVA

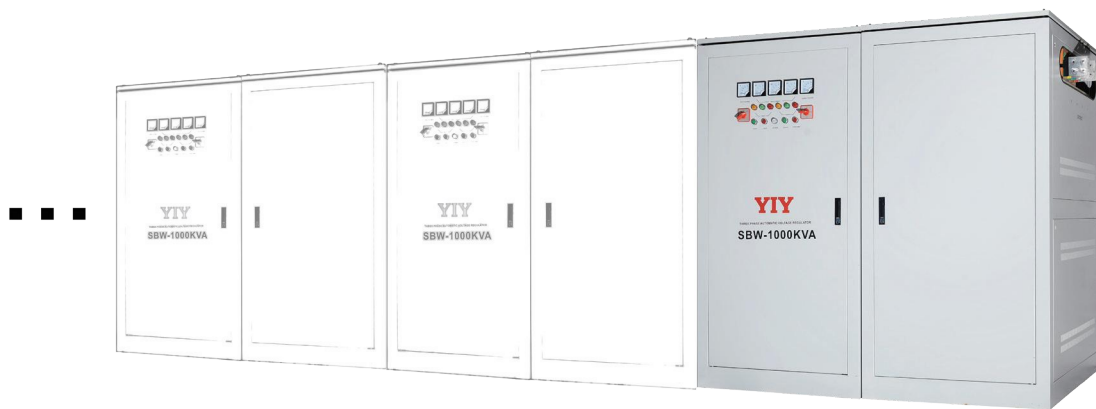

800KVA~3000VA

*800KVA/1000KVA/1200KVA:Cabinet*2. 1500KVA:Cabinet*3 3000KVA:Cabinet*6

• Internal Structure

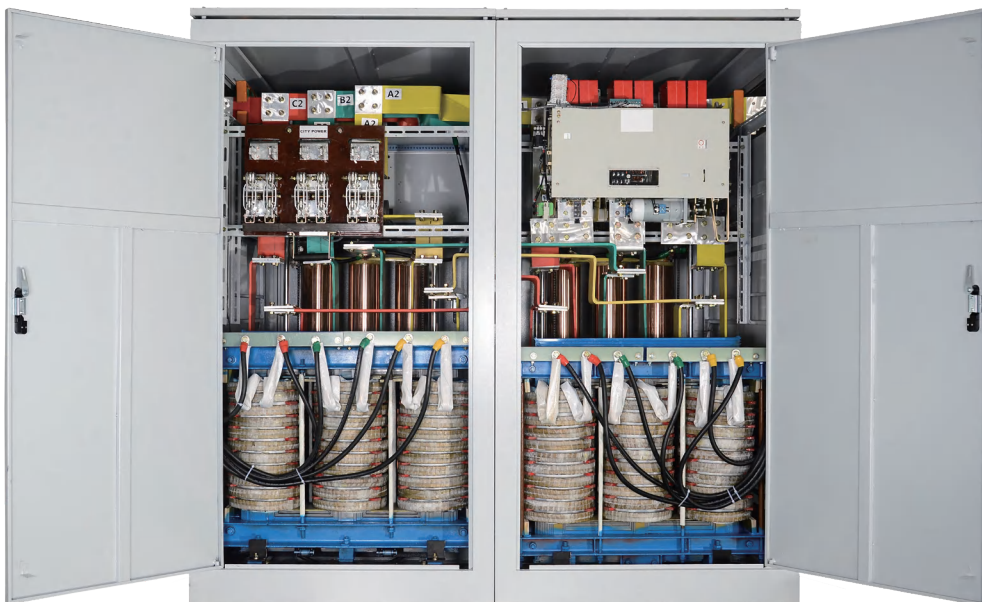
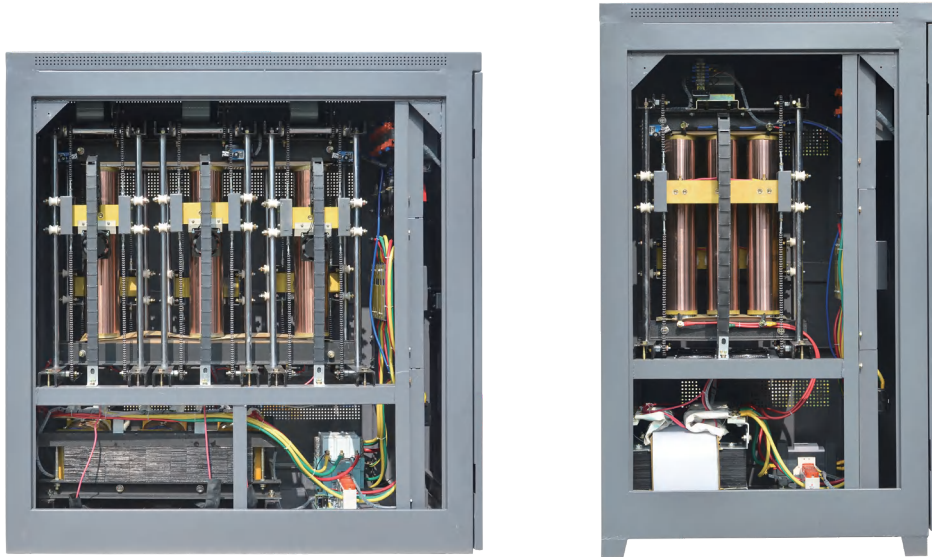

*Different specifications have different layouts

SBW-F IP54

Three Phase Servo Motor Automatic Voltage Regulator

150KVA-3000KVA



The SBW-F Series Three-Phase Automatic Compensation Voltage Stabilizer, designed with advanced European technology, is customizable for different regional needs. It ensures stable output voltage during external grid fluctuations or load changes.

Main advantages include high capacity, efficiency, no waveform distortion, and stable voltage regulation.

SBW-F series with Independent Phase Control: best for unbalanced loads, this model independently regulates each phase, providing precise voltage stability in complex power grid environments.

The SBW-F series stabilizer is widely applied in the field of industry, agriculture, transportation, telecommunications etc, ensuring efficient equipment operation in various scenarios.

• Technical Parameter

Specification		150KVA	200KVA	250KVA	300KVA	400KVA
Input	Phase	3-phase 4-wire				
	Voltage	AC 304V-456V(±20%)/285V-475V(±25%)/266V-494V(±30%)				
	Frequency	50Hz/60Hz				
Output	Voltage	AC 380V±3%/400V±3%				
	Capacity	120KW	160KW	200KW	240KW	320KW
	Frequency	50Hz/60Hz				
Bypass	Current	400A	400A	630A	630A	800A
Protection	Low voltage	318±7V/335±7V				
	Over voltage	425V±7V/442V±7V				
	Time delay	10 seconds				
	Overload	MCU(cutting off output for 60 seconds when exceeding rated power by 120%)				
	Short circuit	Circuit Breaker				
	Other	Surge, phase-sequence, phase loss				

Specification		500KVA	600KVA	1000KVA	1500KVA	2000KVA	3000KVA
Input	Phase	3-phase 4-wire					
	Voltage	AC 304V-456V(±20%)/285V-475V(±25%)/266V-494V(±30%)					
	Frequency	50Hz/60Hz					
Output	Voltage	AC 380V±3%/400V±3%					
	Capacity	400KW	480KW	800KW	1200KW	1600KW	2400KW
	Frequency	50Hz/60Hz					
Bypass	Current	1000A	1250A	2250A	3200A	4000A	6300A
Protection	Low voltage	318±7V/335±7V					
	Over voltage	425V±7V/442V±7V					
	Time delay	10 seconds					
	Overload	MCU (cutting off output for 60 seconds when exceeding rated power by 120%)					
	Short circuit	Circuit Breaker					
	Other	Surge, phase-sequence, phase loss					



• Product Appearance

SBW-F IP54

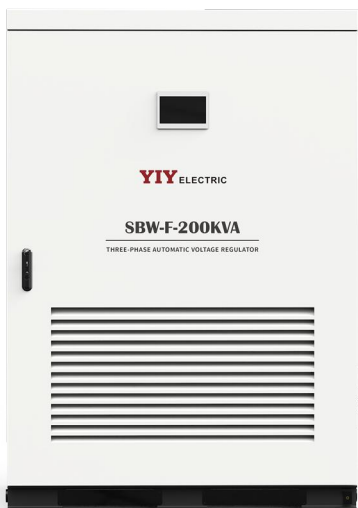

150-300KVA

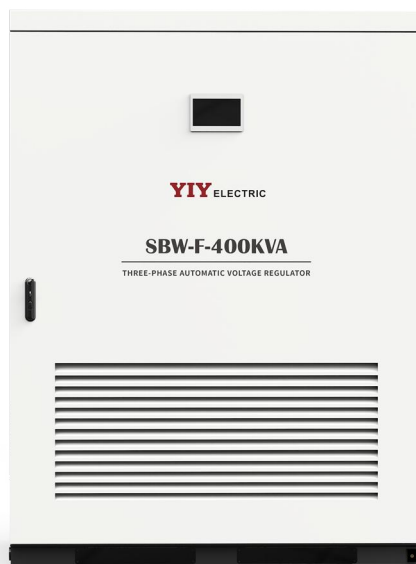

400KVA



1000KVA

AVR

Single Phase Relay Type

500VA-20000VA



Features:

- ◆ MCU controlled PCB
- ◆ Short delay (5s) & Long delay (255s)
- ◆ Wide input voltage range
- ◆ Short circuit & Overload protection
- ◆ Over temperature protection
- ◆ High output precision up to $\pm 8\%$

• Technical Parameter

Specification		500VA	1000VA	1500VA	2000VA	3000VA
Input	Phase	Single phase				
	Voltage	70V-270V/ 90V-270V/125V-270V/140V-260V				
	Frequency	50Hz/60Hz				
Output	Response time	60ms				
	Voltage	AC 220V ±8%~10%				
	Capacity	400W	800W	1200W	1600W	2400W
	Frequency	50Hz/60Hz				
Protection	Low voltage	184V±4V				
	Over voltage	246V±4V				
	Time Delay	5s / 255s optional				
	Overload/ short circuit	Fuse/MCB+MCU				
Packaging	Pcs per Carton	8		4		2
	Shipping Wt.(kg)	19.5	25.8	14.6	16.6	17.6
	Package dimensions (mm)	550*285*350		370*330*403		565*390*305
Efficiency	AC-AC	95%				
Acoustic	Noise level	≤50dB				
Environment	Temperature	-5°C to 40°C				
	Humidity	20% to 90%				

Specification		5000VA	8000VA	10KVA	12KVA	15KVA (Tower)	20KVA (Tower)
Input	Phase	Single phase					
	Voltage	70V-270V/ 90V-270V / 125V-270V/ 140V-260V			90V~270V/125V~270V/ 140V~260V		
	Frequency	50Hz/60Hz					
Output	Response time	60ms					
	Voltage	AC 220V ±8%~10%					
	Capacity	4000W	6400W	8KW	9.6KW	12KW	16KW
	Frequency	50Hz/60Hz					
Protection	Low voltage	184V±4V					
	Over voltage	246V±4V					
	Time Delay	5s / 255s optional					
	Overload/ short circuit	Fuse/MCB+MCU					
Packaging	Pcs per Carton	2	1				
	Shipping Wt.(kg)	23.7	15.3	18.4	18.6	19.4	27.1
	Package dimensions (mm)	565*390*305	455*390*305			390*390*495	390*330*605
Efficiency	AC-AC	95%					
Acoustic	Noise level	≤50dB					
Environment	Temperature	-5°C to 40°C					
	Humidity	20% to 90%					

• Product Appearance

AVR B

*Case color can be customized



500VA/1000VA



1500VA/2000VA



3000VA/5000VA



8000VA/10000VA/
12000VA

AVR D

*Case color can be customized



500VA/1000VA



1500VA/2000VA



3000VA/5000VA



8000VA/10000VA/
12000VA

AVR E

*Case color can be customized



500VA/1000VA



1500VA/2000VA

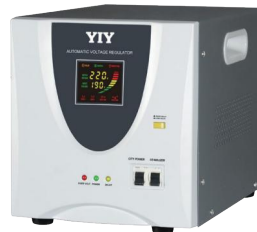

3000VA/5000VA



8000VA/10000VA/
12000VA

AVR F

*Case color can be customized



500VA



1000VA/1500VA



3000VA/5000VA



8000VA/10000VA/
12000VA

• Product Appearance

AVR-Cabinet



15000VA

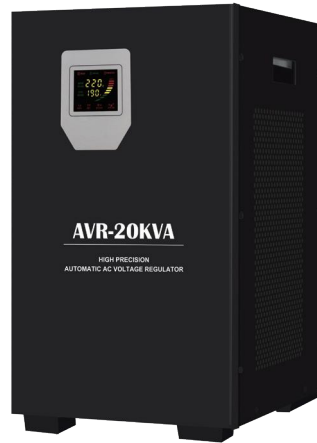

20000VA

◆ Rear Panel

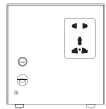

• 500VA-2000VA



• 3000VA

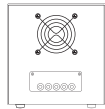

• 5000VA-12000VA



• 5000VA-12000VA

◆ Display Options



• A



• B



• C



• D



• Dual LED display 1



• Dual LED display 2



• LED display



• Analog display

◆ Socket Options



• Universal



• UK 13



• UK 15



• European



• Indian R6



• US

* More options, please turn to page 42

TRS

Wall Mounted Single Phase Relay Type

500VA-20000VA



Features:

- ◆ MCU controlled circuit offering precision output
- ◆ High efficiency toroidal transformer
- ◆ Relay failure detection
- ◆ Individual switching power supply for 12Vdc
- ◆ Zero cross transfer technology integrated protection
- ◆ Ultra-low input voltage
- ◆ Over load Protection (MCU)
- ◆ Super fast response times $\leq 60\text{ms}$

• Technical Parameter

Specification		500VA	1000VA	1500VA	2000VA	3000VA
Input	Phase	Single phase				
	Voltage	AC 70V-270V / 90V-270V / 125V-270V / 140V-260V				
	Frequency	50Hz / 60Hz				
Output	Response	60ms				
	Voltage time	AC 220V ±8%~10%				
	Capacity	400W	800W	1200W	1600W	2400W
	Frequency	50Hz / 60Hz				
Protection	Low voltage	184V±4V				
	Over voltage	246V±4V				
	Time Delay	5s / 255s Selectable				
	Overload/ short circuit	Fuse / MCB+MCU				
Packaging	Pcs per Carton	10		4		2
	Shipping Wt.(kg)	19.5	25.8	14.6	16.6	17.6
	Package dimensions (mm)	440*335*275		415*310*270		425*315*365
Efficiency	AC-AC	95%				
Acoustic	Noise level	≤50dB				
Environment	Temperature	-5°C to 40°C				
	Humidity	20% to 90%				

Specification		5000VA	8000VA	10KVA	12KVA	15KVA (cabinet)	20KVA (cabinet)
Input	Phase	Single phase					
	Voltage	AC 70V-270V / 90V-270V / 125V-270V / 140V-260V			AC 90V~270V / 125V~270V / 140V~260V		
	Frequency	50Hz / 60Hz					
Output	Response	60ms					
	Voltage time	AC 220V ±8%~10%(230V / 240V Optional)			AC 220V ±8%~10%(230V / 240V Optional)		
	Capacity	4000W	6400W	8KW	9.6KW	12KW	16KW
	Frequency	50Hz / 60Hz					
Protection	Low voltage	184V±4V					
	Over voltage	246V±4V					
	Time Delay	5s / 255s Selectable					
	Overload/ short circuit	Fuse / MCB+MCU					
Packaging	Pcs per Carton	2	1				
	Shipping Wt.(kg)	23.7	15.3	18.4	18.6	19.4	27.1
	Package dimensions (mm)	425*315*365			482*358*225		492*585*255
Efficiency	AC-AC	95%					
Acoustic	Noise level	≤50dB					
Environment	Temperature	-5°C to 40°C					
	Humidity	20% to 90%					

• Product Appearance

TRS

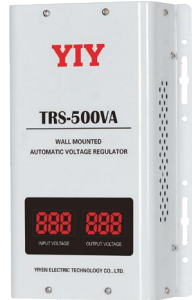

500VA/1000VA

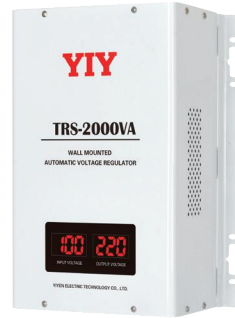

1500VA/2000VA

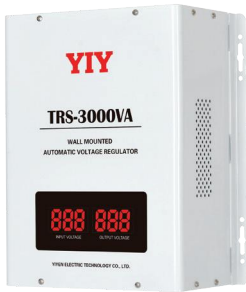

3000VA/5000VA

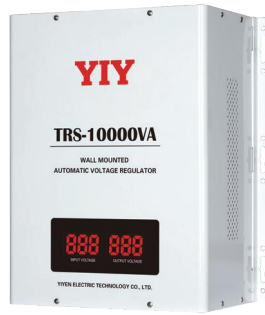

8000VA/10000VA/12000VA

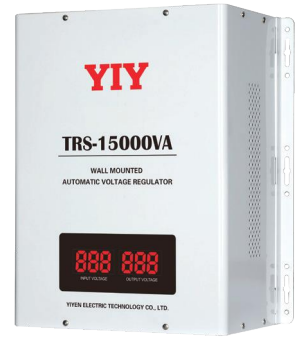

15000VA/20000VA

◆ Bottom Panel

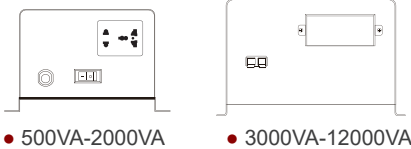

• 500VA-2000VA

• 3000VA-12000VA

◆ Display Options

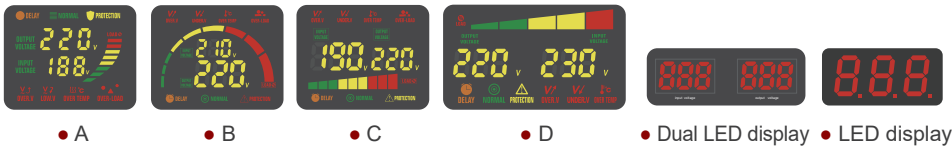

• A

• B

• C

• D

• Dual LED display • LED display

◆ Socket Options

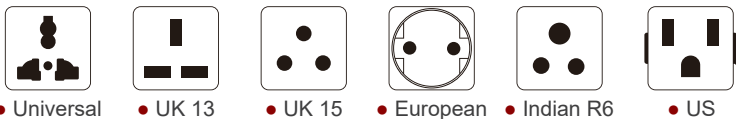

• Universal

• UK 13

• UK 15

• European

• Indian R6

• US

* More options, please turn to page 38

SWR

Wall Mounted Single Phase Relay Type

500VA-30000VA



Features:

- ◆ MCU controlled circuit offering precision output
- ◆ High efficiency toroidal transformer
- ◆ Relay failure detection
- ◆ Individual switching power supply for 12Vdc
- ◆ Zero cross transfer technology integrated protection
- ◆ Ultra-low input voltage
- ◆ Over load Protection (MCU)
- ◆ Super fast response time $\leq 60\text{ms}$

• Technical Parameter

Specification		0.5KVA	1KVA	1.5KVA	2KVA	3KVA
Input	Phase	Single phase				
	Voltage	AC 90V-275V				
	Frequency	50Hz/60Hz				
Output	Voltage	AC 220V±10%/230V±10%				
	Capacity	400W	800W	1200W	1600W	2400W
	Frequency	50Hz/60Hz				
Protection	Low voltage	184±4V/194±4V				
	Over voltage	246V±4V/256V±4V				
	Time delay	5s (255s optional)				
	Overload	MCU (cutting off output for 3 seconds when exceeding rated power by 120%)				
	Short circuit	Circuit Breaker				
	Other	Surge protection (optional)				
Efficiency	AC-AC	98%				
Acoustic	Noise level	≤50dB				
Environment	Temperature	-5°C to 40°C				
	Humidity	20% to 90%				

Specification		5KVA	8KVA	10KVA	12KVA	15KVA	20KVA	30KVA
Input	Phase	Single phase						
	Voltage	AC 45V-275V / 90V-275V						
	Frequency	50Hz/60Hz						
Output	Voltage	VAC 220V±10%/230V±10%						
	Capacity	4000W	6400W	8KW	9.6KW	12KW	16KW	24KW
	Frequency	50Hz/60Hz						
Protection	Low voltage	184±4V/194±4V						
	Over voltage	246V±4V/256V±4V						
	Time delay	5s (255s optional)						
	Overload	MCU (cutting off output for 3 seconds when exceeding rated power by 120%)						
	Short circuit	Circuit Breaker						
	Other	Surge protection (optional)						
Efficiency	AC-AC	98%						
Acoustic	Noise level	≤50dB						
Environment	Temperature	-5°C to 40°C						
	Humidity	20% to 90%						

• Product Appearance

SWR

*Case color can be customized



500/1500VA



3000VA



5000VA



10000/15000VA



20000VA



30000VA

◆ Bottom Panel

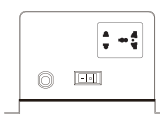

• 500VA-2000VA



• 3000VA-30000VA

◆ Display Options



• A



• B



• C



• D



• Dual LED display

PR

Portable Single Phase Relay Type

500VA-2000VA



Features:

- ◆ CPU control
- ◆ Component damage protection
- ◆ Short circuit and overload protection
- ◆ Selectable delay time
- ◆ Over temperature protection
- ◆ LED indicators to show status of working, over voltage, and low voltage
- ◆ Automatic voltage regulation/Extension socket
- ◆ Protection against brownouts and over voltages
- ◆ Digital meter indicates line voltage and output voltage
- ◆ Surge, spike, and lightning protection (optional)

• Technical Parameter

Specification		500VA	1000VA	1500VA	2000VA
Input	Phase	Single phase			
	Voltage	AC 125V-270V / 140V-260V			
	Frequency	50Hz/60Hz			
Output	Voltage	AC 220V ±10%			
	Capacity	250W	500W	750W	1000W
	Frequency	50Hz/60Hz			
Protection	Low voltage	184V±5V			
	Over voltage	246V±5V			
	Time Delay	5s / 255s			
	Overload/ short circuit	Fuse/MCB			
Packaging	Pcs per Carton	9			
	Net Wt.(kg)	1.3	1.6	1.75	1.8
	Shipping Wt.(kg)	11.9	14.3	15.5	16.8
	Package dimensions (mm)	528*320*360			
Efficiency	AC-AC	95%			
Acoustic	Noise level	≤50dB			
Environment	Temperature	-5°C to 40°C			
	Humidity	20% to 90%			

• Product Appearance



Euro Standard



Multifunctional Socket



H:7.5CM



W:14.0CM

L:26.0CM



H:9.9CM



W:13.5CM

E:26.0CM

CVCF

IGBT Type Single Phase AVR

Voltage and Frequency Stabilisers



Input voltage range:

- ◆ 85-270VAC, 1Phase, 2Wire, +Earth

Input frequency range:

- ◆ 35-70Hz

Features:

- ◆ Correction time 10ms
- ◆ Output accuracy +/-0.5%
- ◆ Output wave form distortion THD<3%
- ◆ Effect of Power factor PF>0.99
- ◆ Frequency protection
- ◆ Compatible with generator

• Technical Parameter

Parameters	Power Rating	5KVA	10KVA
Input Voltage	Nominal voltage Rating	230VAC 1Phase, 2Wire, +Earth	
	Voltage Range	85-270VAC	
	Frequency	35-70Hz	
Output Voltage	Voltage	220V/230V/240V ± 0.5%	
	Correction time	10ms	
	Voltage Regulation	±0.5%	
	Output wave form distortion	THD<3%	
	Output frequency	50/60Hz	
	Power factor	PF>0.99	
	Protection	Automatic bypass	Yes
Manual bypass		Yes	
Input Under Voltage		80±1V	
Input Over Voltage		280±3V	
Output Under Voltage		184V/@220V 192V/@230,201V/@240V	
Output Over Voltage		246V/@220V,250V/@230V,260V/@240V	
Over-temperature		Module: 80°C Protection/Recovery at 65°C	
Output Overload		110%>&<120%-5S,(3 times) 120%>&<150%-2S (3 times) >150% cut off immediately	
Display/Indication	Display mode	LCD/LED	
	Communication	RS485	
Physical parameter	Efficiency	Better Than 95%	
	Cooling method	Forced cooling	
	IP	IP20	
	Temperature	0-45°C	
	Humidity	0-95%(RH-Non Condensing)	
	Noise	<60dB	
	Product Size	501*328*128.5 mm	580*358*128.5 mm
	Shipping Size	590*440*240 mm	670*470*240 mm
	Product Weight	10KG	12KG
	Shipping Weight	12KG	14KG

AVC

Active Voltage Conditioner

Voltage Sag Correction, Surge Correction, Continuous Voltage Regulation and Load Voltage Compensation.



Active Voltage Conditioner (AVC) mainly consists of a rectifier, inverter, compensation transformer, monitoring system, and AC/DC power distribution. This comprehensive power quality management device, equipped with functions such as voltage fluctuation (-40%~+30%) control, reactive power compensation, harmonic filter, and three-phase imbalance compensation, improves the power quality of the grid while ensuring stable power supply to the load, thus preventing economic losses caused by voltage fluctuations.

• Product Dimensions

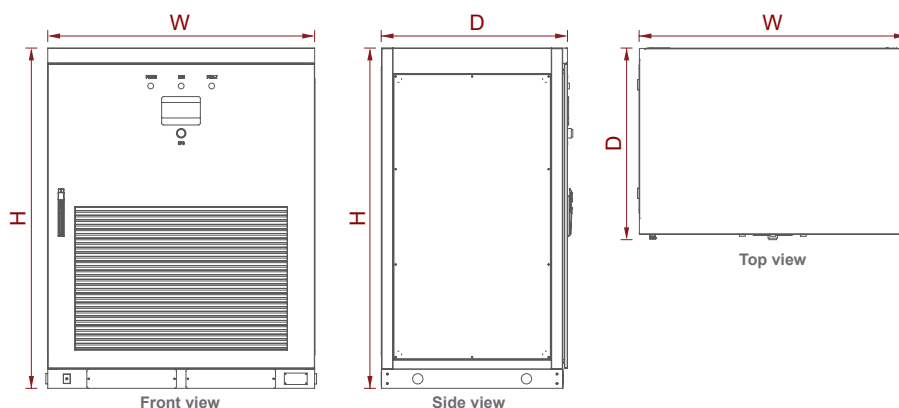

Model	Size(W*D*H) (mm)
AVC-3-150KVA	850*800*1400
AVC-3-250KVA	1400*975*1785
AVC-3-500KVA	1400*975*1785
AVC-3-1000KVA	2800*975*1785

• Working Principle

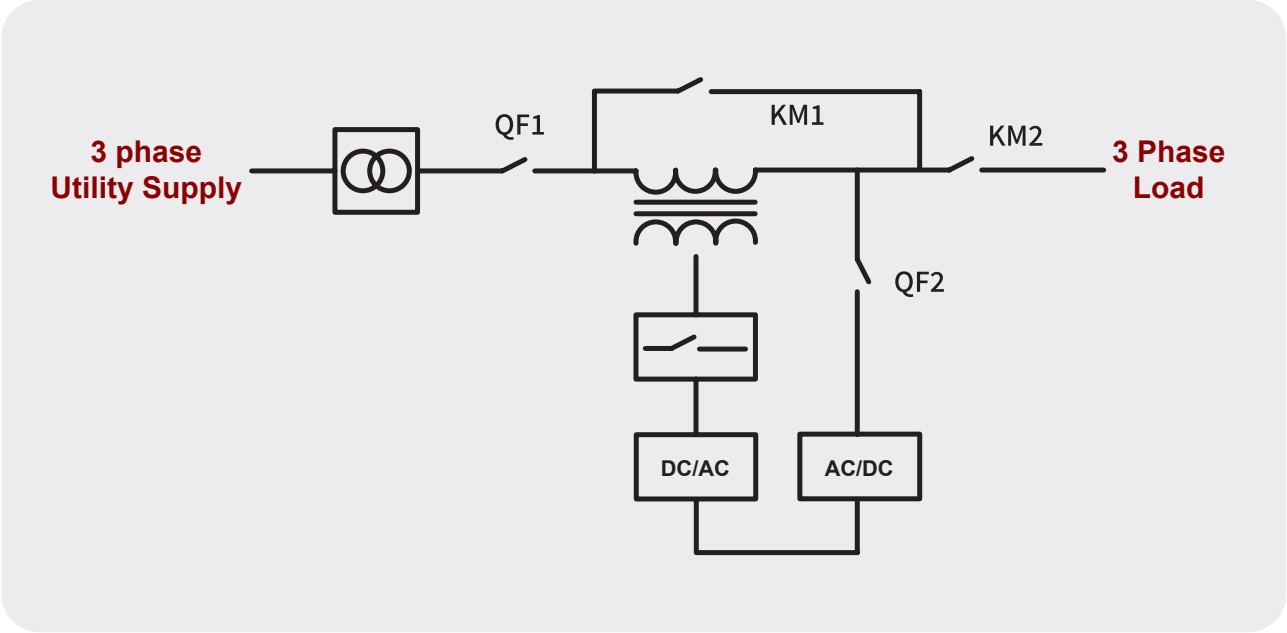

• Applications

• New energy



• Traffic tunnels



• Industrial production



• Continuous process



• Pharmaceutical industry



• Medical industry



• Technical Specifications

Active Voltage Conditioner		
AC parameters		
Rated capacity	15/20/30KVA	45KVA-2000KVA
Rated Voltage	AC220V	AC380V
Voltage range	-40%~+30%	-40%~+30%
Rated frequency	50Hz/60Hz	50Hz/60Hz
Grid structure	Single phase	3 phase 4 wire
AC overload	1.1 times	1.1 times
Output voltage accuracy	±1%	±1%
Function Selection	Voltage compensation + (reactive power compensation, harmonic compensation, reactive power compensation + harmonic compensation)	Voltage compensation + (reactive power compensation, harmonic compensation, three-phase imbalance compensation, reactive power compensation + harmonic compensation, reactive power compensation + three-phase imbalance compensation, reactive power compensation + three-phase imbalance + harmonic compensation)
Compensation voltage range	AC 220±20% (-40%~+30% can be customized)	AC 380±20% (-40%~+30% can be customized)
Transformer ratio	5:1	5:1
Harmonic compensation rate	3rd-13th order comprehensive harmonic compensation ≥95%	3rd-13th order comprehensive harmonic compensation ≥95%
Reactive Power Compensation Rate	Reactive power compensation ≥ 98%	Reactive power compensation ≥ 98%
Three-phase imbalance compensation rate	/	Three-phase imbalance compensation ≥ 95%
Total current harmonic distortion rate	≤3%	≤3%
Output voltage harmonic distortion rate	< 1.5%	< 1.5%
Compensation response time	< 20ms	< 20ms
Transformer parameters		
Rated capacity	6KVA	12KVA~400KVA
Type	Dry type, the magnetic core is made of laminated silicon steel sheets, and the frame is grounded.	Dry type, the magnetic core is made of laminated silicon steel sheets, and the frame is grounded.
Overload	1.1x Extended Operation	1.1 times longer running time
Insulation	Insulation class H	Insulation class H
Transformation ratio	220:44	220:44
Design temperature	Temperature rise ≤90K	Temperature rise ≤90K
Implementation standards	IEC 726	IEC 726
System parameters		
Altitude	For distances less than 2000m and above 2000m, use the equipment with reduced rating according to GB/T3859.2.	For distances less than 2000m and above 2000m, use the equipment with reduced rating according to GB/T3859.2.
Ambient temperature	-10 ~ +50°C (derating above 40°C)	-10 ~ +50°C (derating above 40°C)
Relative Humidity	≤90%, no condensation on the surface at the lowest monthly temperature of 25°C	≤90%, no condensation on the surface at the lowest monthly temperature of 25°C
Pollution Level	Below level III	Below level III
Noise	≤70dB	≤70dB
Protection level	IP20/IP54	IP20/IP54

PWR-LV

Single Phase Servo Motor Type

5KVA-100KVA



Features:

- ◆ Low input voltage
- ◆ More accurate output precision $\leq 2\%$
- ◆ Over voltage & Under voltage protection
- ◆ Themistor, upgraded function to offer more accurate over-heat protection to the device.
- ◆ If fan is not working, the device will cut off the output to avoid over-heat.
- ◆ Overload protection (on PCB) $\geq 120\%$
- ◆ MCU control
- ◆ Multi display
- ◆ Surge protection



• Technical Parameter

Specification		5KVA	10KVA	15KVA	20KVA	30KVA	40KVA	50KVA	75KVA	100KVA
Input	Phase	Single Phase								
	Voltage	AC 96V-144V								
	Frequency	50Hz/60Hz								
Output	Voltage	AC 120V±3%(110/127V±3%optional)								
	Capacity	4KW	8KW	12KW	16KW	24KW	32KW	40KW	60KW	80KW
	Frequency	50Hz/60Hz								
Protection	Low Voltage	100±4V(92 ±4V/106 ±4V)								
	Over Voltage	134 ±4V(123 ±4V/ 142±4V)								
	Time Delay	5s / 255s optional								
	Overload	MCU (cutting off output for 3 seconds when exceeding rated power by 120%)								
	Short Circuit	Circuit Breaker								
	Other	Surge protection								
Efficiency	AC-AC	98%								
Acoustic	Noise level	≤50dB								
Environment	Temperature	-5°C to 40°C								
	Humidity	20% to 90%								

• Product Appearance

PWR-LV



PWR-LV-15K



PWR-LV-20K



PWR-LV-30K

◆ Display Options



• A

• B

• C

• D

TWS-LV

Wall-mounted Single Phase Servo Motor Type

5KVA-30KVA



Features:

- ◆ Ultra-low input voltage
- ◆ Over voltage & Under voltage protection
- ◆ Reaction time(voltage stabilization time) $\leq 2s$
- ◆ High precision: $120VAC \pm 3\%$
- ◆ Over temperature protection
- ◆ Short delay (5s) & Long delay (255s)

• Technical Parameter

Specification		5KVA	10KVA	15KVA	20KVA	30KVA
Input	Phase	Single phase				
	Voltage	AC 90V-140V				
	Frequency	50Hz/60Hz				
Output	Voltage	AC 120V±3%(110V/127V±3% optional)				
	Capacity	2400W	4000W	8KW	12KW	16KW
	Frequency	50Hz/60Hz				
Protection	Low voltage	100±4V/(92±4V/106±4V)				
	Over voltage	134V±4V(123±4V/142V±4V)				
	Time delay	5s (255s optional)				
	Overload	MCU (cutting off output for 3 seconds when exceeding rated power by 120%)				
	Short circuit	Circuit Breaker				
Other	Surgee protection(optional)					
Product	Dimension	340*460*160	340*460*160	540*725*240	540*725*240	540*725*240
Efficiency	AC-AC	98%				
Acoustic	Noise level	≤50dB				
Environment	Temperature	-5°C to 40°C				
	Humidity	20% to 90%				

• Product Appearance

TWS-LV



TWS-LV-5K



TWS-LV-10K



TWS-LV-15K



TWS-LV-20K



TWS-LV-30K

◆ Bottom Panel

- 5000VA-30000VA

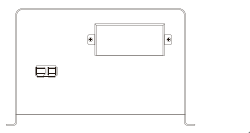

◆ Display Options



• A

• B

• C

• D

PWR-2

Dual Phase Servo Motor Type

10KVA-60KVA



Features:

- ◆ Low input voltage
- ◆ More accurate output precision $\leq 2\%$
- ◆ Over voltage & Under voltage protection
- ◆ Themistor, upgraded function to offer more accurate over-heat protection to the device.
- ◆ If fan is not working, the device will cut off the output to avoid over-heat.
- ◆ Overload protection (on PCB) $\geq 120\%$
- ◆ MCU control
- ◆ Multi display
- ◆ Surge protection



• Technical Parameter

Specification		10KVA	15KVA	20KVA	30KVA	45KVA	50KVA	60KVA
Input	Phase	Dual Phase						
	Voltage	AC 96V-144V						
	Frequency	50Hz/60Hz						
Output	Voltage	AC 120V/240V±3%(110/220V±3%optional)						
	Capacity	8KW	12KW	16KW	24KW	36KW	40KW	48KW
	Frequency	50Hz/60Hz						
Protection	Low Voltage	100±4V/200±4V						
	Over Voltage	134±4V/268±4V						
	Time Delay	5s / 255s optional						
	Overload	MCU (cutting off output for 3 seconds when exceeding rated power by 120%)						
	Short Circuit	Circuit Breaker						
	Other	Surge protection						
Efficiency	AC-AC	98%						
Acoustic	Noise level	≤50dB						
Environment	Temperature	-5 C to 40 C						
	Humidity	20% to 90%						

• Product Appearance

PWR-2



PWR-2-20K



PWR-2-30K



PWR-2-50K

◆ Display Options



• A

• B

• C

• D

PWR-3-LV

Three Phase Servo Motor Type

15KVA-300KVA

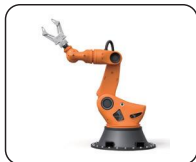

Features:

- ◆ More accurate output precision $\leq 2\%$
- ◆ MCU Control
- ◆ Surge protection
- ◆ Industrial strength components
- ◆ If fan fails, the device will cut off the output to avoid over-heat
- ◆ 100% unbalanced loading capability
- ◆ Ultra-low input voltage
- ◆ Overload protection (on PCB) $\geq 120\%$
- ◆ Multi display

• Technical Parameter

Specification		15KVA	30KVA	45KVA	60KVA	75KVA	100KVA
Input	Phase	3-phase 3-wire					
	Voltage	AC 166V-250V(±20%)/156V-260V(±25%)/145V-270V(±30%)					
	Frequency	50Hz/60Hz					
Output	Voltage	AC 208V±3%/220V±3%					
	Capacity	12KW	24KW	36KW	48KW	60KW	80KW
	Frequency	50Hz/60Hz					
Protection	Low voltage	174±4V/184±4V					
	Over voltage	233V±4V/246V±4V					
	Time delay	5s					
	Overload	MCU (cutting off output for 3 seconds when exceeding rated power by 120%)					
	Short circuit	Circuit Breaker					
	Other	surge, phase-sequence, phase loss					
Efficiency	AC-AC	98%					
Acoustic	Noise level	≤50dB					
Environment	Temperature	-5°C to 40°C					
	Humidity	20% to 90%					

Specification		120KVA	150KVA	200KVA	250KVA	300KVA
Input	Phase	3-phase 3-wire				
	Voltage	AC 166V-250V(±20%)/156V-260V(±25%)/145V-270V(±30%)				
	Frequency	50Hz/60Hz				
Output	Voltage	AC 208V±3%/220V±3%				
	Capacity	96KW	120KW	160KW	200KW	240KW
	Frequency	50Hz/60Hz				
Protection	Low voltage	174±4V/184±4V				
	Over voltage	233V±4V/246V±4V				
	Time delay	5s				
	Overload	MCU (cutting off output for 3 seconds when exceeding rated power by 120%)				
	Short circuit	Circuit Breaker				
	Other	surge, phase-sequence, phase loss				
Efficiency	AC-AC	98%				
Acoustic	Noise level	≤50dB				
Environment	Temperature	-5°C to 40°C				
	Humidity	20% to 90%				



• Product Appearance

PWR-3-LV



PWR-3-LV-30KVA



PWR-3-LV-45KVA



PWR-3-LV-60KVA



PWR-3-LV-100KVA



PWR-3-LV-150KVA

◆ Display

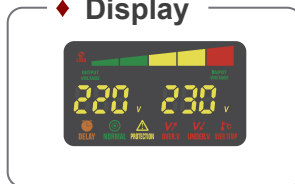

• D

SBW-F IP54

Three Phase Servo Motor Automatic Voltage Regulator

300KVA-3000KVA



The SBW-F Series Three-Phase Automatic Compensation Voltage Stabilizer, designed with advanced European technology, is customizable for different regional needs. It ensures stable output voltage during external grid fluctuations or load changes.

Main advantages include high capacity, efficiency, no waveform distortion, and stable voltage regulation.

SBW-F series with Independent Phase Control: best for unbalanced loads, this model independently regulates each phase, providing precise voltage stability in complex power grid environments.

The SBW-F series stabilizer is widely applied in the field of industry, agriculture, transportation, telecommunications etc, ensuring efficient equipment operation in various scenarios.



• Technical Parameter

Specification		300KVA	400KVA	500KVA	600KVA	1500KVA	2000KVA	3000KVA
Input	Phase	3-phase 3-wire						
	Voltage	AC 480V±16%						
	Frequency	50Hz/60Hz						
Output	Voltage	AC 480V±3%						
	Capacity	240KW	320KW	400KW	480KW	1200KW	1600KW	2400KW
	Frequency	50Hz/60Hz						
Bypass	Current	630A	800A	1000A	1250A	3200A	4000A	6300A
Protection	Low voltage	420±7V						
	Over voltage	525V±7V						
	Time delay	10 seconds						
	Overload	MCU(cutting off output for 60 seconds when exceeding rated power by 120%)						
	Short circuit	Circuit Breaker						
	Other	surge, phase-sequence, phase loss						

• Product Appearance

SBW-F



300KVA



400KVA



1000KVA

SWR-LV

Wall Mounted Single Phase Relay Type

500VA-15000VA



Features:

- ◆ MCU controlled circuit offering precision output
- ◆ High efficiency toroidal transformer
- ◆ Relay failure detection
- ◆ Individual switching power supply for 12Vdc
- ◆ Zero cross transfer technology integrated protection
- ◆ Ultra-low input voltage
- ◆ Over load Protection (MCU)
- ◆ Super fast response time $\leq 60\text{ms}$

• Technical Parameter

Specification		0.5KVA	1KVA	1.5KVA	2KVA	3KVA
Input	Phase	Single phase				
	Voltage	AC 80V-150V				
	Frequency	50Hz/60Hz				
Output	Voltage	AC 127V±10%				
	Capacity	400W	800W	1200W	1600W	2400W
	Frequency	60Hz				
Protection	Low voltage	106±4V				
	Over voltage	142V±4V				
	Time delay	5s (255s optional)				
	Overload	MCU (cutting off output for 3 seconds when exceeding rated power by 120%)				
	Short circuit	Circuit Breaker				
	Other	Surge protection (optional)				
Efficiency	AC-AC	98%				
Acoustic	Noise level	≤50dB				
Environment	Temperature	-5°C to 40°C				
	Humidity	20% to 90%				

Specification		5KVA	8KVA	10KVA	12KVA	15KVA
Input	Phase	Single phase				
	Voltage	AC 80V-150V				
	Frequency	50Hz/60Hz				
Output	Voltage	AC 127V±10%				
	Capacity	4000W	6400W	8KW	9.6KW	12KW
	Frequency	50Hz/60Hz				
Protection	Low voltage	106±4V				
	Over voltage	142V±4V				
	Time delay	5s (255s optional)				
	Overload	MCU (cutting off output for 3 seconds when exceeding rated power by 120%)				
	Short circuit	Circuit Breaker				
	Other	Surge protection (optional)				
Efficiency	AC-AC	98%				
Acoustic	Noise level	≤50dB				
Environment	Temperature	-5°C to 40°C				
	Humidity	20% to 90%				

• Product Appearance

SWR

*Case color can be customized



500/1500VA



3000VA



5000VA



10000/15000VA



20000VA



30000VA

◆ Bottom Panel

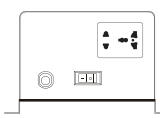

• 500VA-2000VA



• 3000VA-30000VA

◆ Display Options



• A



• B



• C



• D



• Dual LED display

ST

Step Up & Down Transformer

500VA-2000VA



ST Step up/down voltage converter ,we have two transformers for your option.EI transformer/Toroidal transformer.

Input voltage range:

- ◆ 110V/200V/220V/240V

Ouput frequency range:

- ◆ 110V & 220V or customized

Features:

- ◆ Step Up/ Down Voltage Converter
- ◆ EI Transformer / Toroidal Transformer
- ◆ Durable Enclosure
- ◆ Power Source Indicating Switch

• Product Appearance



50VA/75VA



100VA/150VA



200VA/250VA/300VA



500VA/750VA



1000VA/1500VA/2000VA

TDGC₂/TSGC₂

Manual Voltage Regulator



• Technical Parameter

Specification & Capacity	Max output capacity KVA	Rated input voltage V	Rated output voltage V	Max output current A	Overall size (W*D*L)mm	TQY(PCI)	Package size/set (W*D*L)mm	Net weight kg	Gross werght kg	no of phase
TSGC ₂ -1.5	1.5	380V	0-430V	2	125x180x340	1	200x260x400	9.8	12	3
TSGC ₂ -3	3.0			4	180x250x430	1	300x220x510	17	21.5	
TSGC ₂ -6	6.0			8	180x250x460	1	330x220x560	22	27	
TSGC ₂ -9	9.0			12	210x250x590	1	320x260x580	29	35	
TSGC ₂ -15	15.0			20	240x330x560	1	390x295x650	48	56	
TSGC ₂ -20	20.0			27	240x330x580	1	390x295x650	53	60	
TSGC ₂ -30	30.0			40	350x420x1060	1	440x450x1170	138	150	

Specification & Capacity	Max output capacity KVA	Rated input voltage V	Rated output voltage V	Max output current A	Overall size (W*D*L)mm	TQY(PCI)	Package size/set (W*D*L)mm	Net weight kg	Gross werght kg	no of phase
TDGC ₂ -0.2	0.2	220V	0-250V	0.8	105x130x130	12	380x347x350	25	26.5	1
TDGC ₂ -0.5	0.5			2	125x150x130	8	380x347x350	27	28	
TDGC ₂ -1	1.0			4	180x200x210	4	435x255x465	25	26	
TDGC ₂ -2	2.0			8	180x200x210	4	435x255x465	31.5	33	
TDGC ₂ -3	3.0			12	210x230x230	2	490x275x290	21.5	23	
TDGC ₂ -5	5.0			20	240x285x250	1	330x275x290	17.5	18	
TDGC ₂ -10	10.0			40	240x335x400	1	390x295x505	34	40	
TDGC ₂ -15	15.0			60	240x335x560	1	390x295x650	50	58	
TDGC ₂ -20	20.0			80	240x340x590	1	390x295x650	53	60	

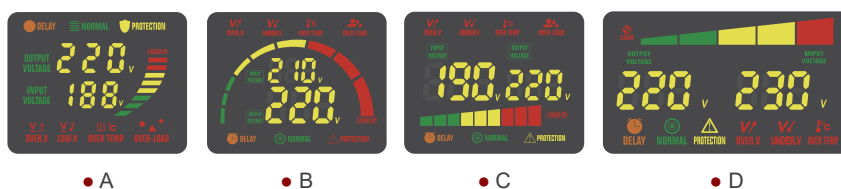
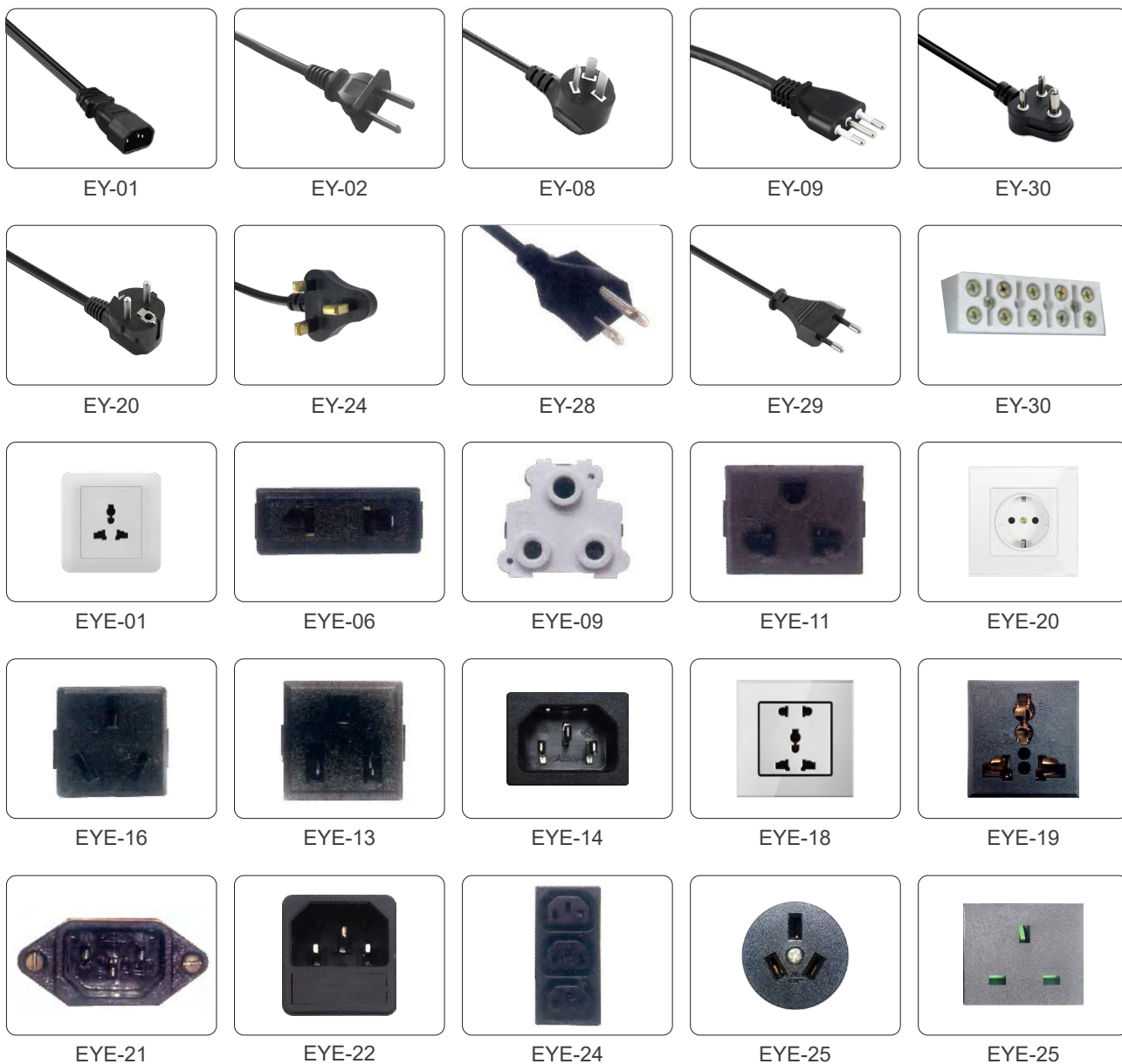

Global Branches & Agents

KINMO PW CORPORATION

Contact Nos.: T 8251-0507 T 8251-0508

Mobile No.: +63977-840-7799

Email: kinmopw.ph@gmail.com

Main Office:1732 Jose Abad Santos St., Tondo Manila, Philippines

BGC Office:Unit 3C-1 Seibu Tower, 6th Ave., 24th St., BGC Taguig City

SMone Energy sp. z o.o.

Main product : Power Quality

Ul.Sikorskiego 72 43-100 Tychy, Poland

Contact person: Szymon Lubecki

Telephone:+48 538 328 899office@smone.pl

Electro Zimbabwe

Main product : Power Quality

Website: www.electro.co.zw

Email: cecil@electro.co.zw

Cellphone: +263 774 325 839

Telephone:+263 8677007530/(+263 24)2481120/952

Add: 20 Harrow Road, Msasa, Harare, Zimbabwe

KIARA GREENENERGY SDN BHD

Malaysia Agent

CEO: DANIEL NG

Email: daniel@yiyen.com

Telephone:+60102091616

Add: No.1 Jalan Usahawan 2/1, Elmina Bu Siness Park, 47000 Sungai Buloh, Selangor

FRA.TE.L.S.R.L(Italy)

Main product : C&I Energy Storage Solutions

Add: CIS TORRE ISOLA4 IP INT 410 SNC CAP, 80035 Nola NA, Italy

Contact person: Francesco Casillo



**Energy Storage System
&
Power Quality System Provider**

ZHEJIANG YIYEN HOLDING GROUP CO.,LTD

Tel: +86-577-27772199 27772139

Email: yiyen@yiyen.com

Website: www.yiyen.com

PQ Website: www.yiyelec.com

WENZHOU YIYEN SUPPLY CHAIN MANAGEMENT CO.,LTD

Add: Rm.1301.Building 3.Headquarters Economic Park .No.6688
Xuyang Road. Yueqing City. 325600.Zhejiang

LISHUI YIYEN TECHNOLOGY CO.,LTD

Add:No.77,Xiang Long Road,Lian Du Zone,Lishui City,Zhejiang
Province, China