

# End Pieces DATA SHEET ZL-2813 series



## Description

The end pieces are specially designed for water manifold, and integrate automatic exhaust and drainage function.

## Technical Specifications

### Performance

- Applicable medium: Water、 glycol solutions  
Max. percentage of glycol is 30%
- Maximum pressure for air valve: 10bar
- Maximum working temperature: 110°C

### Materials

Valve Body	Brass
Handle	AL
Seals	EPDM

## Characteristic Components

- ①-Drain valve(ZL424712)      ②-Triple-valve body      ③-Air vent      ④-Non-return joint

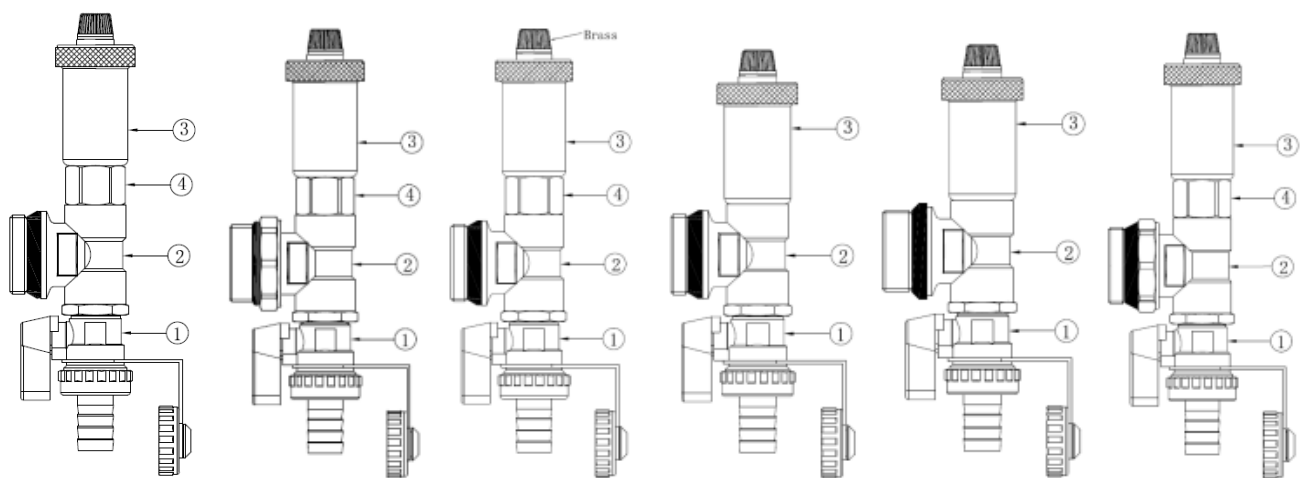

ZL2813

ZL2813B

ZL2813C

ZL2813D

ZL2813F

ZL2813G

# Dimensions

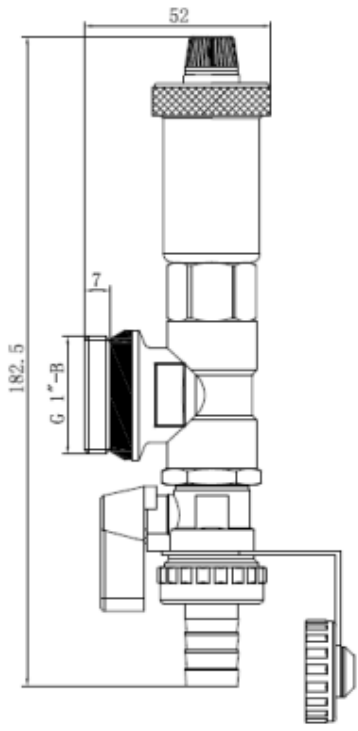

Code	ZL2813
------	--------

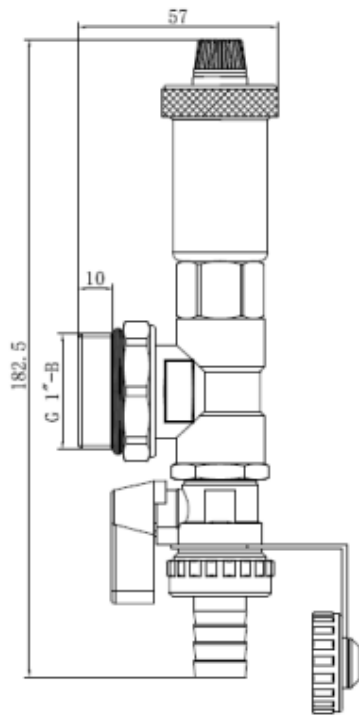

Code	ZL2813B
------	---------

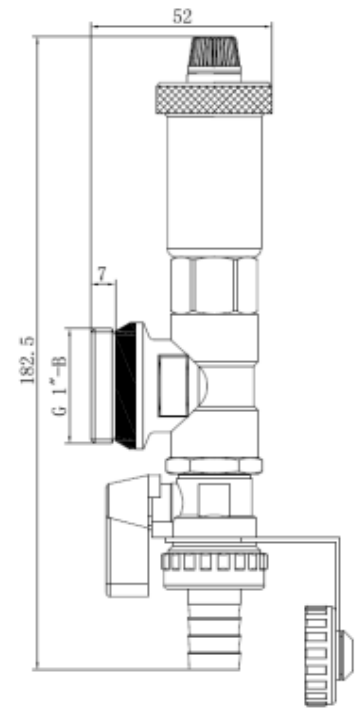

Code	ZL2813C
------	---------

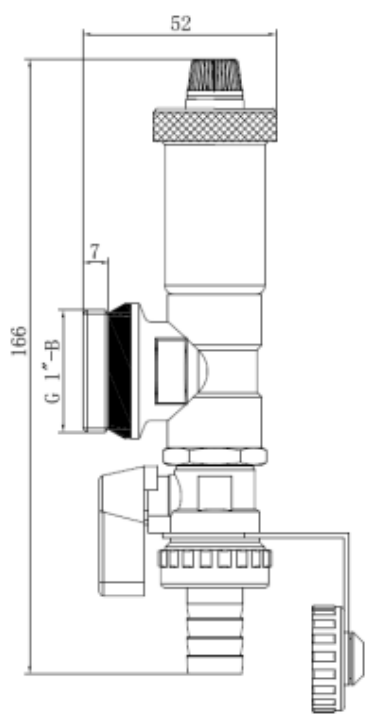

Code	ZL2813D
------	---------

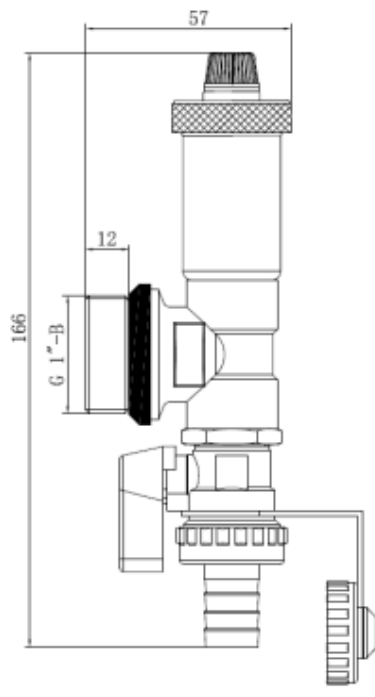

Code	ZL2813F
------	---------

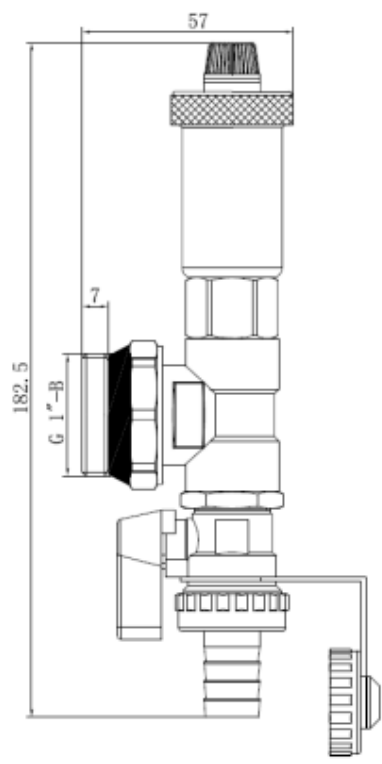

Code	ZL2813G
------	---------