

# KINGSTAR<sup>+</sup>

Simple is more  
极简更有内涵



金思达公众号  
Wechat



金思达微官网  
Website

广东金思达家居五金有限公司  
GUANGDONG KINGSTAR  
FURNITURE ACCESSORIES CO.,LTD

广东省佛山市顺德区勒流镇百丈工业区工业一路之三  
No.3, Industrial Road No.1, Baizhang Industrial, Leliu  
Town, Shunde, Foshan, Guangdong, China.

邮箱Mail: E-mai: Janet@chinakingstar.net  
电话Tel: 0757-25534515  
网址Web: www.chinakingstar.net





**在五金行业  
金思达未来将如何持续闪耀全球舞台？**

In the hardware industry  
How will KINGSTAR continue to shine on  
the global stage in the future?

**因理念而闪耀**

实现从“满足功能需求”  
到“重塑家居品位”的突破

**Shine with idea**  
complete the breakthrough from "meeting  
functional requirements" to "reinventing  
the home"

**因价值而闪耀**

提升产品和服务水平  
为品牌增值赋能

**Shine with value**  
improve the quality of products and  
services empower the brand to add value

**因远见而闪耀**

提供全屋五金一站式解决方案

**Shine with vision**  
Provide one-stop hardware solutions for  
the whole house

**因服务而闪耀**

以效率留住客户 以服务赢得市场

**Shine with service**  
Retain customers with efficiency and win  
the market with service

# INTRODUCTION

公司简介

KINGSTAR

# HONORS

荣誉与资质



21项发明专利, 51项实用新型专利  
21 invention patents and 51 utility model patents



- 1.公司规模：广东顺德厂区占地面积35000平方米，我们有超过235名训练有素的工人；我们有5000万美元的生产能力。
- 2.主要产品：钢珠滑轨，隐藏托底滑轨，抽屉系统，桌腿，铰链，三合一紧固件等家具五金及塑料配件。
- 3.主要市场：北美和西欧...几乎遍布全世界70多个国家
- 4.工厂资质：ISO9001、ISO14001、SGS、RHOS、BSCI、TUV等认证；专利50余项；我们拥有超过15年的研发、生产和全球销售经验
- 5.欢迎所有OEM和ODM

- 1.Scale of company : Shunde guangdong factory area is 35,000 square meters, We have more than 235 trained workers; We have 50 million USD\$ production capacity.
- 2.Main products: ball bearing slide, undermounted slide, drawer system, table leg, hinge, mini fixing and so on furniture hardware and plastic fittings.
- 3.Main market: North America and West Europe... almost all over the world more than 70 countries
- 4.Factory qualification: ISO9001, ISO14001, SGS, RHOS, BSCI, TUV...certificate; More than 50 patents; We have 15+ years of R&D, production and worldwide sales experience
- 5.All OEM & ODM are welcome

**DRAWER SYSTEM SERIES**  
抽屉系统



|                               |       |
|-------------------------------|-------|
| 德立抽系列<br>DELUXE DRAWER SERIES | 03/04 |
| 酷立抽系列<br>COSPLA DRAWER SERIES | 05/06 |
| 骑马抽系列<br>TENDER BOX SERIES    | 07/08 |

**G6 QUADRO UNDERMOUNTED SLIDE SERIES**  
G6隐藏轨系列

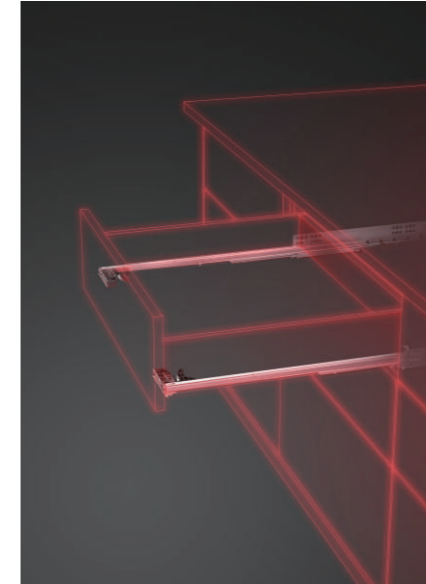

|   |       |
|---|-------|
| 三节轻奢滚珠隐藏轨<br>FULL EXTENSION QUADRO UNDERMOUNTED SLIDE   | 23/24 |
| 二节轻奢滚珠隐藏轨<br>SINGLE EXTENSION QUADRO UNDERMOUNTED SLIDE | 25/26 |

**UNDERMOUNTED SLIDE SERIES**  
隐藏轨系列

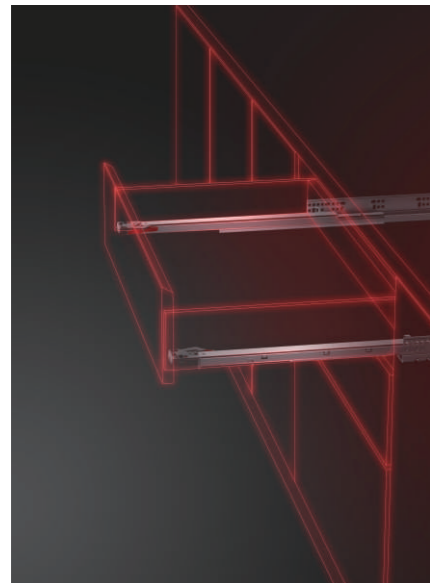

|  |       |
|--|-------|
| 防倾倒全拉出三节阻尼隐藏轨 把手款<br>ANTI-TIPPING SOFT CLOSING FULL EXTENSION UNDERMOUNTED SLIDE WITH QUICK RELEASE HANDLE | 11/11 |
| 全拉出同步隐藏轨<br>SYNCHRONIZED FULL EXTENSION UNDERMOUNTED SLIDE   | 11/11 |
| 全拉出三节隐藏轨<br>FULL EXTENSION UNDERMOUNTED SLIDE  | 12/14 |
| 全拉出三节美式阻尼隐藏轨 把手款<br>SOFT CLOSING FULL EXTENSION UNDERMOUNTED SLIDE WITH ADJUSTABLE PIN                     | 14/14 |
| 7/8拉出二节阻尼隐藏轨<br>2 FOLD 7/8 EXTENSION UNDERMOUNTED SLIDE  | 15/15 |
| 半拉出二节隐藏轨<br>SINGLE EXTENSION UNDERMOUNTED SLIDE  | 16/17 |
| 拉篮轨<br>WIRE BASKET SLIDE   | 19/20 |

**BALL BEARING SLIDE SERIES**  
钢珠轨系列



|  |       |
|--|-------|
| 防倾倒H45三节钢珠轨<br>ANTI-TIPPING H45MM BALL BEARING SLIDE | 29/29 |
| H45 三节钢珠轨<br>H45MM BALL BEARING SLIDE                | 29/30 |
| H35 三节钢珠轨<br>H35MM BALL BEARING SLIDE                | 31/31 |
| H27 二节钢珠轨<br>H27MM SINGLE BALL BEARING SLIDE         | 32/32 |
| 后托<br>END SOCKET                                     | 32/32 |

HEAVY DUTY SLIDE SERIES  
重型滑轨系列

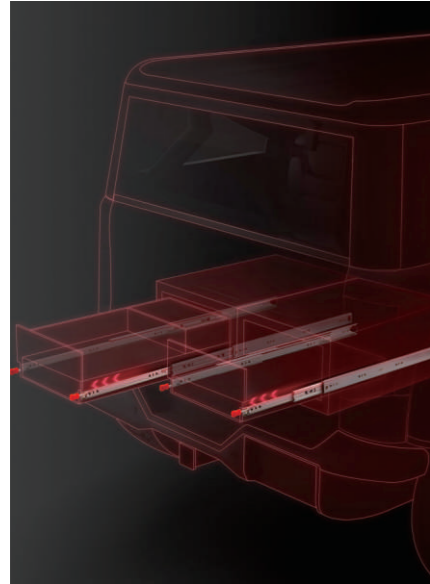

|  |       |
|--|-------|
| H76 三节重型滑轨<br>H76MM HEAVY DUTY FULL EXTENSION BALL BEARING SLIDE | 35/35 |
| H53 三节重型滑轨<br>H53MM HEAVY DUTY FULL EXTENSION BALL BEARING SLIDE | 36/37 |
| H51 三节重型滑轨<br>H51MM HEAVY DUTY FULL EXTENSION BALL BEARING SLIDE | 37/38 |
| H50 三节重型滑轨<br>H50MM HEAVY DUTY FULL EXTENSION BALL BEARING SLIDE | 39/39 |
| H48*51*51 三节楼梯滑轨<br>H48*51*51MM STAIRWAY BALL BEARING SLIDE      | 40/40 |

HINGE SERIES  
铰链系列

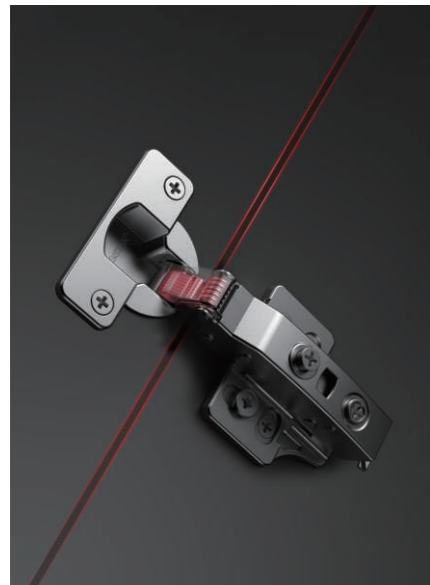

|  |       |
|--|-------|
| Φ35 一段力缓冲铰链<br>Φ35 ONE WAY HYDRAULIC BUFFERING HINGES                          | 43/43 |
| Φ35二段力缓冲铰链<br>Φ35 TWO WAY HYDRAULIC BUFFERING HINGES                           | 44/44 |
| Φ35小角度厚门缓冲铰链<br>Φ35 SMALL ANGLE THICK DOOR(16-25MM) HYDRAULIC BUFFERING HINGES | 45/46 |
| Φ28铝框门缓冲铰链<br>Φ28 ALUMINUM FRAME DOOR HYDRAULIC BUFFERING HINGES               | 47/48 |
| Φ35特殊角度缓冲铰链<br>Φ35 SPECIAL ANGLE HYDRAULIC BUFFERING HINGES                    | 48/51 |
| 美式铰链<br>AMERICAN HINGES  | 52/54 |

FURNITURE LEG SERIES  
家具脚系列



|                        |       |
|------------------------|-------|
| 桌子架<br>TABLE FRAME LEG | 57/58 |
| 桌子脚<br>TABLE LEG       | 59/60 |
| 沙发脚<br>SOFA LEG        | 61/63 |
| 橱柜脚<br>CABINET LEG     | 64/64 |

FURNITURE COMPONENT SERIES  
家具组件系列

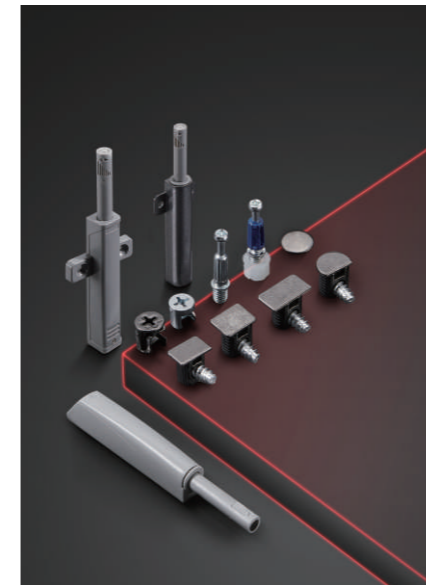

|  |       |
|--|-------|
| 偏心轮<br>CAMS                                      | 67/68 |
| 快装预埋件<br>NUTS                                    | 68/68 |
| 组合式快装螺杆<br>DOWELS                                | 69/70 |
| 层板托偏心层板连接件<br>BOARD CONNECTORS                   | 71/72 |
| 衣通管&衣通托<br>WARDROBE TUBE & WARDROBE TUBE SUPPORT | 73/74 |
| 柜门反弹器<br>CABINET BOUNCER                         | 74/74 |

# DRAWER SYSTEM SERIES

抽屉系统系列



双层豪华抽屉侧帮系统  
DOUBLE WALL DRAWER SYSTEM

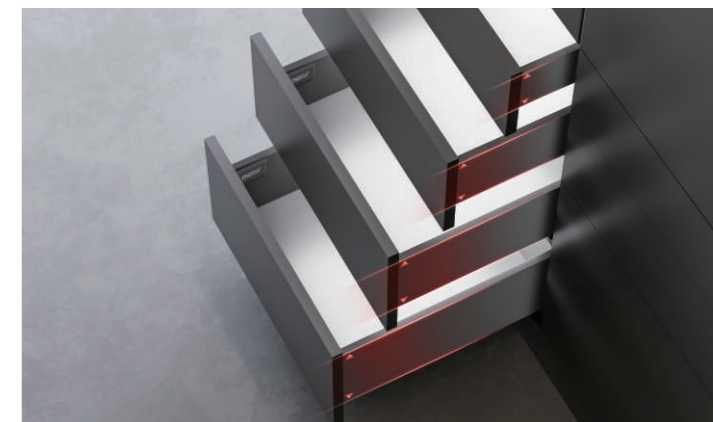

单层抽屉侧帮系统  
SINGLE WALL DRAWER SYSTEM

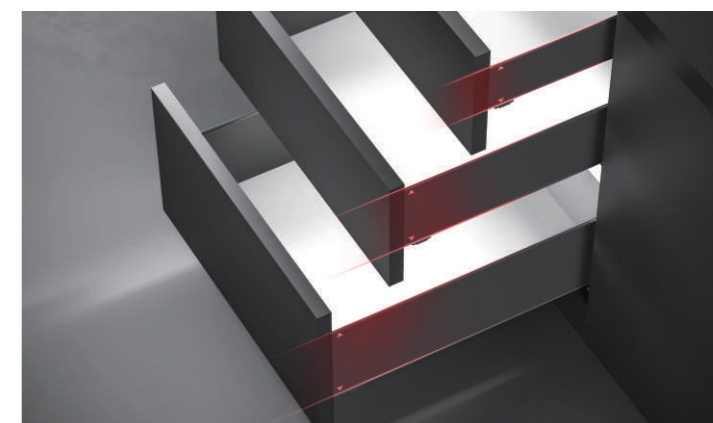

骑马抽系统  
TENDER BOX SYSTEM





### SM181/SM161



- 特点**
- 1.无需要加工抽屉侧板
  - 2.适用于任何款式的隐藏滑轨
  - 3.调节范围上下/左右 ±1.5MM
  - 4.表面处理:铁灰/白色喷粉
  - 5.抽屉底板(16/18MM厚度)
- Advantage**
- 1.Drawer slide panels without processing
  - 2.Applicable to all the undermounted slides
  - 3.Adjustment range: up and down/left and right direction, ±1.5mm
  - 4.Finish: iron grey/white powder
  - 5.Drawer bottom board (T=16mm or T=18mm)



名称 德立抽H89  
Name DELUXE DRAWER BOX H89

厚度 1.0mm Thickness 1.0mm  
规格 250-550mm Specification 250-550mm



### SM183/SM163



- 特点**
- 1.无需要加工抽屉侧板
  - 2.适用于任何款式的隐藏滑轨
  - 3.调节范围上下/左右 ±1.5MM
  - 4.表面处理:铁灰/白色喷粉
  - 5.抽屉底板(16/18MM厚度)
- Advantage**
- 1.Drawer slide panels without processing
  - 2.Applicable to all the undermounted slides
  - 3.Adjustment range: up and down/left and right direction, ±1.5mm
  - 4.Finish: iron grey/white
  - 5.Drawer bottom board (T=16mm or T=18mm)



名称 德立抽H152  
Name DELUXE DRAWER BOX H152

厚度 1.0mm Thickness 1.0mm  
规格 250-550mm Specification 250-550mm



### SM182/SM162



- 特点**
- 1.无需要加工抽屉侧板
  - 2.适用于任何款式的隐藏滑轨
  - 3.调节范围上下/左右 ±1.5MM
  - 4.表面处理:铁灰/白色喷粉
  - 5.抽屉底板(16/18MM厚度)
- Advantage**
- 1.Drawer slide panels without processing
  - 2.Applicable to all the undermounted slides
  - 3.Adjustment range: up and down/left and right direction, ±1.5mm
  - 4.Finish: iron grey/white
  - 5.Drawer bottom board (T=16mm or T=18mm)



名称 德立抽H121  
Name DELUXE DRAWER BOX H121

厚度 1.0mm Thickness 1.0mm  
规格 250-550mm Specification 250-550mm



### SM184/SM164



- 特点**
- 1.无需要加工抽屉侧板
  - 2.适用于任何款式的隐藏滑轨
  - 3.调节范围上下/左右 ±1.5MM
  - 4.表面处理:铁灰/白色喷粉
  - 5.抽屉底板(16/18MM厚度)
- Advantage**
- 1.Drawer slide panels without processing
  - 2.Applicable to all the undermounted slides
  - 3.Adjustment range: up and down/left and right direction, ±1.5mm
  - 4.Finish: iron grey/white
  - 5.Drawer bottom board (T=16mm or T=18mm)



名称 德立抽H185  
Name DELUXE DRAWER BOX H185

厚度 1.0mm Thickness 1.0mm  
规格 250-550mm Specification 250-550mm



DJ001



- 特点**
- 1.无需要加工抽屉侧板
  - 2.适用于任何款式的隐藏滑轨
  - 3.超薄款侧板，抽屉增大25-40MM利用空间
  - 4.表面处理铁灰/白色喷粉
  - 5.适用抽屉底板(10-18MM厚度)
- Advantage**
- 1.Drawer slide panels without processing
  - 2.Applicable to all the undermounted slide
  - 3.Ultra-slim box, maximize 25-40MM available space of drawer
  - 4.Finish: iron grey/white
  - 5.Available drawer bottom board thickness (T=10-18MM)

名称 酷立抽H80  
Name COSPLA DRAWER BOX H80

厚度 1.5mm Thickness 1.5mm  
规格 250-550mm Specification 250-550mm



DJ003



- 特点**
- 1.无需要加工抽屉侧板
  - 2.适用于任何款式的隐藏滑轨
  - 3.超薄款侧板，抽屉增大25-40MM利用空间
  - 4.表面处理铁灰/白色喷粉
  - 5.适用抽屉底板(10-18MM厚度)
- Advantage**
- 1.Drawer slide panels without processing
  - 2.Applicable to all the undermounted slide
  - 3.Ultra-slim box, maximize 25-40MM available space of drawer
  - 4.Finish: iron grey/white
  - 5.Available drawer bottom board thickness (T=10-18MM)

名称 酷立抽H150  
Name COSPLA DRAWER BOX H150

厚度 1.5mm Thickness 1.5mm  
规格 250-550mm Specification 250-550mm



DJ002



- 特点**
- 1.无需要加工抽屉侧板
  - 2.适用于任何款式的隐藏滑轨
  - 3.超薄款侧板，抽屉增大25-40MM利用空间
  - 4.表面处理铁灰/白色喷粉
  - 5.适用抽屉底板(10-18MM厚度)
- Advantage**
- 1.Drawer slide panels without processing
  - 2.Applicable to all the undermounted slide
  - 3.Ultra-slim box, maximize 25-40MM available space of drawer
  - 4.Finish: iron grey/white
  - 5.Available drawer bottom board thickness (T=10-18MM)

名称 酷立抽H120  
Name COSPLA DRAWER BOX H120

厚度 1.5mm Thickness 1.5mm  
规格 250-550mm Specification 250-550mm



DJ004



- 特点**
- 1.无需要加工抽屉侧板
  - 2.适用于任何款式的隐藏滑轨
  - 3.超薄款侧板，抽屉增大25-40MM利用空间
  - 4.表面处理铁灰/白色喷粉
  - 5.适用抽屉底板(10-18MM厚度)
- Advantage**
- 1.Drawer slide panels without processing
  - 2.Applicable to all the undermounted slide
  - 3.Ultra-slim box, maximize 25-40MM available space of drawer
  - 4.Finish: iron grey/white
  - 5.Available drawer bottom board thickness (T=10-18MM)

名称 酷立抽H200  
Name COSPLA DRAWER BOX H200

厚度 1.5mm Thickness 1.5mm  
规格 250-550mm Specification 250-550mm





名称 超薄骑马抽 H86

Name ULTRA TENDER BOX H86

## UMD001

- 特点
- 1.无需要加工抽屉侧板
  - 2.内置三维调节面板上下/左右/前后
  - 3.卡扣与侧板一体设计实现一键拆卸
  - 4.带缓冲软关闭装置，承重可达35KG

- Advantage
1. Drawer side panels without processing
  2. Front panel 3D adjustment
  3. Integrated buckle and side panel to achieve easily assembly and disassembly.
  4. Soft closing function, loading capacity up to 35KGS

厚度 1.2mm Thickness 1.2mm

规格 300-550mm Specification 300-550mm



名称 超薄骑马抽 H167

Name ULTRA TENDER BOX H167

## UMD003

- 特点
- 1.无需要加工抽屉侧板
  - 2.内置三维调节面板上下/左右/前后
  - 3.卡扣与侧板一体设计实现一键拆卸
  - 4.带缓冲软关闭装置，承重可达35KG

- Advantage
1. Drawer side panels without processing
  2. Front panel 3D adjustment
  3. Integrated buckle and side panel to achieve easily assembly and disassembly.
  4. Soft closing function, loading capacity up to 35KGS

厚度 1.2mm Thickness 1.2mm

规格 300-550mm Specification 300-550mm



名称 超薄骑马抽 H116

Name ULTRA TENDER BOX H116

## UMD002

- 特点
- 1.无需要加工抽屉侧板
  - 2.内置三维调节面板上下/左右/前后
  - 3.卡扣与侧板一体设计实现一键拆卸
  - 4.带缓冲软关闭装置，承重可达35KG

- Advantage
1. Drawer side panels without processing
  2. Front panel 3D adjustment
  3. Integrated buckle and side panel to achieve easily assembly and disassembly.
  4. Soft closing function, loading capacity up to 35KGS

厚度 1.2mm Thickness 1.2mm

规格 300-550mm Specification 300-550mm



名称 超薄骑马抽 H199

Name ULTRA TENDER BOX H199

## UMD004

- 特点
- 1.无需要加工抽屉侧板
  - 2.内置三维调节面板上下/左右/前后
  - 3.卡扣与侧板一体设计实现一键拆卸
  - 4.带缓冲软关闭装置，承重可达35KG

- Advantage
1. Drawer side panels without processing
  2. Front panel 3D adjustment
  3. Integrated buckle and side panel to achieve easily assembly and disassembly.
  4. Soft closing function, loading capacity up to 35KGS

厚度 1.2mm Thickness 1.2mm

规格 300-550mm Specification 300-550mm



## T84



### 特点

- 1.无需要加工抽屉侧板
- 2.带阻尼结构承重30公斤
- 3.表面处理:铁灰/白色喷粉
- 4.固定方式:销钉或把手
- 5.调节范围:上下/左右 ±1.5MM

### Advantage

- 1.Drawer slide panels without processing
- 2.Loading capacity 30 KGS with soft closing
- 3.Finish: iron grey/white
- 4.Fixing method: pin and clip
- 5.Adjustment range: up and down/left and right direction, ±1.5mm

名称 骑马抽H84

Name TENDER BOX (H84MM)

厚度 0.8mm

Thickness 0.8mm

规格 270-600mm

Specification 270-600mm



## T200



### 特点

- 1.无需要加工抽屉侧板
- 2.带阻尼结构承重30公斤
- 3.表面处理:铁灰/白色喷粉
- 4.固定方式:销钉或把手
- 5.调节范围:上下/左右 ±1.5MM

### Advantage

- 1.Drawer slide panels without processing
- 2.Loading capacity 30 KGS with soft closing
- 3.Finish: iron grey/white
- 4.Fixing method: pin and clip
- 5.Adjustment range: up and down/left and right direction, ±1.5mm

名称 骑马抽H200

Name TENDER BOX (H200MM)

厚度 0.8mm

Thickness 0.8mm

规格 270-600mm

Specification 270-600mm



## T160



### 特点

- 1.无需要加工抽屉侧板
- 2.带阻尼结构承重30公斤
- 3.表面处理:铁灰/白色喷粉
- 4.固定方式:销钉或把手
- 5.调节范围:上下/左右 ±1.5MM

### Advantage

- 1.Drawer slide panels without processing
- 2.Loading capacity 30 KGS with soft closing
- 3.Finish: iron grey/white
- 4.Fixing method: pin and clip
- 5.Adjustment range: up and down/left and right direction, ±1.5mm

名称 骑马抽H160

Name TENDER BOX (H160MM)

厚度 0.8mm

Thickness 0.8mm

规格 270-600mm

Specification 270-600mm

# UNDERMOUNTED SLIDE SERIES

隐藏轨系列



全拉隐藏轨  
FULL EXTENSION UNDERMOUNTED SLIDE

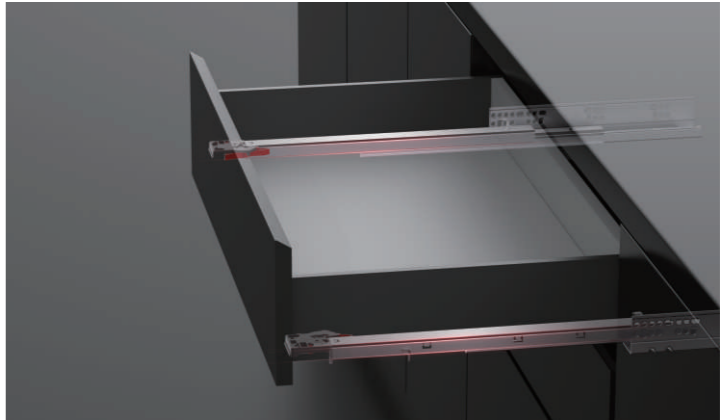

小全拉隐藏轨  
87% EXTENSION UNDERMOUNTED SLIDE

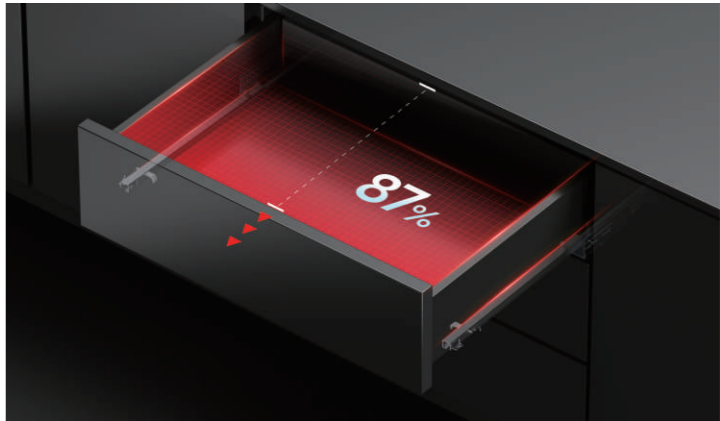

拉篮轨  
WIRE BASKET SLIDE





### 30101BPT/31101BPT



- 特点**
- 1.带防倾倒装置三节隐藏轨
  - 2.抽屉全拉出，一抽屉拉出其它便紧闭
  - 3.抽屉运行顺畅、开合轻柔
  - 4.动态载重：35KG

- Advantage**
- 1.Anti-tipping full extension undermounted slide
  - 2.Full extension, once a drawer is pulled out, the others are locked
  - 3.Smooth running, soft opening and closing
  - 4.Loading capacity: 35KGS

**名称** 防倾倒全拉出三节阻尼隐藏轨 把手款  
**Name** ANTI-TIPPING SOFT CLOSING FULL EXTENSION UNDERMOUNTED SLIDE WITH QUICK RELEASE HANDLE

**料厚** 1.5/1.4mm **Thickness** 1.5/1.4mm  
**规格** 250-550mm **Specification** 250-550mm  
**材质** 镀锌板(SGCC) **Material** Galvanized steel(SGCC)



### T30101B/T31101B



- 特点**
- 1.隐藏式、全拉式滑轨
  - 2.抽屉拆装快捷、简便、运行顺畅
  - 3.抽屉上下调节量: 0~3mm
  - 4.动态载重: 35KG
  - 5.内置联动组件

- Advantage**
- 1.Full extension undermounted slide
  - 2.Easily installed and uninstalled, smooth running
  - 3.Up and down adjustment: 0-3mm
  - 4.Loading capacity: 35KGS
  - 5.Installed with synchronization mechanism

**名称** 全拉出三节联动阻尼隐藏轨 把手款  
**Name** SYNCHRONIZED SOFT CLOSING FULL EXTENSION UNDERMOUNTED SLIDE WITH QUICK RELEASE HANDLE

**厚度** 1.0/1.4/1.8mm **Thickness** 1.0/1.4/1.8mm  
**规格** 250-550mm **Specification** 250-550mm  
**材质** 镀锌板(SGCC) **Material** Galvanized steel(SGCC)



### W30104B/W31104B



- 特点**
- 1.隐藏式、全拉式滑轨
  - 2.抽屉拆装快捷、简便、运行顺畅
  - 3.抽屉上下调节量: 0~3mm
  - 4.动态载重: 35KG
  - 5.外置反弹稳定器和同步平衡杆

- Advantage**
- 1.Full extension undermounted slide
  - 2.Easily installed and uninstalled, smooth running
  - 3.Up and down adjustment: 0-3mm
  - 4.Loading capacity: 35KGS
  - 5.Externally install balancer for the push open slide

**名称** 全拉出同步平衡杆三节触弹隐藏轨 把手款  
**Name** SYNCHRONIZED PUSH TO OPEN FULL EXTENSION UNDERMOUNTED SLIDE WITH BALANCE RAIL

**厚度** 1.0/1.4/1.8mm **Thickness** 1.0/1.4/1.8mm  
**规格** 250-550mm **Specification** 250-550mm  
**材质** 镀锌板(SGCC) **Material** Galvanized steel(SGCC)

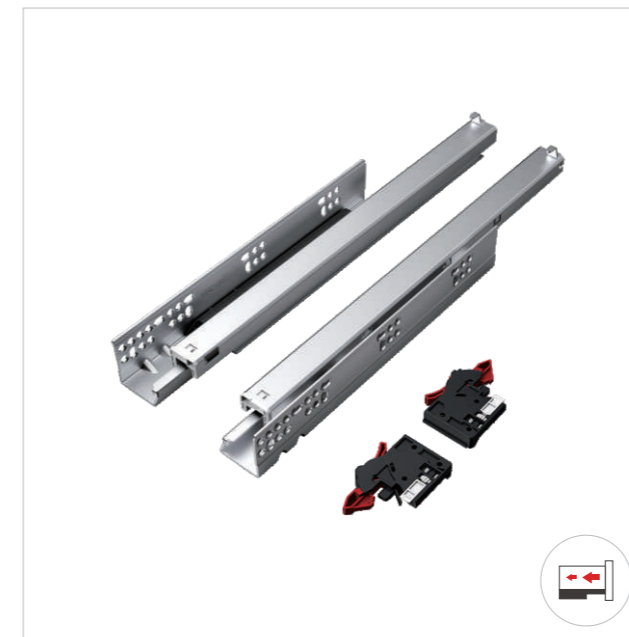

### 30101B/31101B



- 特点**
- 1.隐藏式、抽屉全拉出
  - 2.抽屉拆装快捷、简便、运行顺畅
  - 3.抽屉上下调节量: 0~3MM
  - 4.把手可选: 1D/2D/3D
  - 5.动态载重: 35KG

- Advantage**
- 1.Full extension undermounted slide
  - 2.Easily installed and uninstalled, smooth running
  - 3.Up and down adjustment: 0-3mm
  - 4.Available handles: 1D/2D/3D
  - 5.Loading capacity: 35KGS

**名称** 全拉出三节(阻尼)隐藏轨 把手款  
**Name** (SOFT CLOSING) FULL EXTENSION UNDERMOUNTED SLIDE WITH QUICK RELEASE HANDLE

**厚度** 1.0/1.4/1.8mm **Thickness** 1.0/1.4/1.8mm  
**规格** 250-550mm **Specification** 250-550mm  
**材质** 镀锌板(SGCC) **Material** Galvanized steel(SGCC)

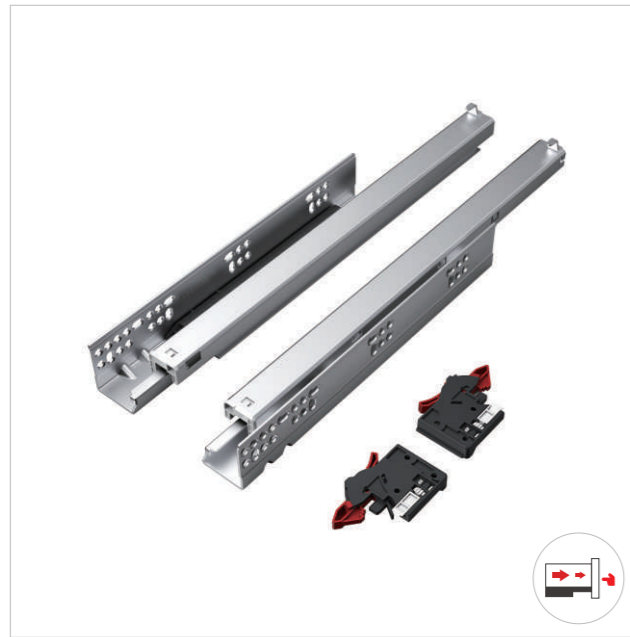

### 30104B/31104B



- 特点**
1. 隐藏式、抽屉全拉出
  2. 抽屉拆装快捷、简便、运行顺畅
  3. 抽屉上下调节量: 0~3MM
  4. 把手可选: 1D/2D/3D
  5. 动态载重: 35KG
- Advantage**
1. Full extension undermounted slide
  2. Easily installed and uninstalled, smooth running
  3. Up and down adjustment: 0-3mm
  4. Available handles: 1D/2D/3D
  5. Loading capacity: 35KGS

**名称** 全拉出三节(触弹)隐藏轨 把手款  
**Name** (PUSH OPEN) FULL EXTENSION UNDERMOUNTED SLIDE WITH QUICK RELEASE HANDLE

**厚度** 1.0/1.4/1.8mm **Thickness** 1.0/1.4/1.8mm  
**规格** 250-550mm **Specification** 250-550mm  
**材质** 镀锌板(SGCC) **Material** Galvanized steel(SGCC)



### 30104A/31104A



- 特点**
1. 隐藏式、抽屉全拉出
  2. 抽屉拆装快捷、简便、运行顺畅
  3. 抽屉上下调节量: 0~3MM
  4. 动态载重: 35KG
- Advantage**
1. Full extension undermounted slide
  2. Easily installed and uninstalled, smooth running
  3. Up and down adjustment: 0-3mm
  4. Loading capacity: 35KGS

**名称** 全拉出三节(触弹)隐藏轨 调整钉插销款  
**Name** (PUSH OPEN) FULL EXTENSION UNDERMOUNTED SLIDE WITH ADJUSTABLE PIN

**厚度** 1.0/1.4/1.8mm **Thickness** 1.0/1.4/1.8mm  
**规格** 250-550mm **Specification** 250-550mm  
**材质** 镀锌板(SGCC) **Material** Galvanized steel(SGCC)



### 30101A/31101A



- 特点**
1. 隐藏式、抽屉全拉出
  2. 抽屉拆装快捷、简便、运行顺畅
  3. 抽屉上下调节量: 0~3MM
  4. 动态载重: 35KG
- Advantage**
1. Full extension undermounted slide
  2. Easily installed and uninstalled, smooth running
  3. Up and down adjustment: 0-3mm
  4. Loading capacity: 35KGS

**名称** 全拉出三节(阻尼)隐藏轨 调整钉插销款  
**Name** (SOFT CLOSING) FULL EXTENSION UNDERMOUNTED SLIDE WITH ADJUSTABLE PIN

**厚度** 1.0/1.4/1.8mm **Thickness** 1.0/1.4/1.8mm  
**规格** 250-550mm **Specification** 250-550mm  
**材质** 镀锌板(SGCC) **Material** Galvanized steel(SGCC)



### 30201B/31201B



- 特点**
1. 隐藏式、全拉式滑轨
  2. 抽屉拆装快捷、简便、运行顺畅
  3. 抽屉上下调节量: 0~3MM
  4. 动态载重: 35KG
  5. 后托可选 铁/ABS,把手可选: 1D/2D/3D
- Advantage**
1. Full extension undermounted slide
  2. Easily installed and uninstalled, smooth running
  3. Up and down adjustment: 0-3mm
  4. Loading capacity: 35KGS
  5. Available end socket: Iron/ABS  
Available handles: 1D/2D/3D

**名称** 美式全拉出三节(阻尼)隐藏轨 把手款  
**Name** (SOFT CLOSING) FULL EXTENSION AMERICAN STYLE UNDERMOUNTED SLIDE WITH QUICK RELEASE HANDLE

**厚度** 1.0/1.4/1.8mm **Thickness** 1.0/1.4/1.8mm  
**规格** 250-550mm **Specification** 250-550mm  
**材质** 镀锌板(SGCC) **Material** Galvanized steel(SGCC)



## 20101FB/21101FB



- 特点**
1. 隐藏式、抽屉拉出7/8
  2. 抽屉拆装快捷、简便、运行顺畅
  3. 抽屉上下调节量：0~3MM
  4. 动态载重：20KG

- Advantage**
1. 87% extension undermounted slide
  2. Easily installed and uninstalled, smooth running
  3. Up and down adjustment: 0-3mm
  4. Loading capacity: 20KGS

**名称** 7/8拉出二节阻尼隐藏轨 把手款  
**Name** 2 FOLD SOFT CLOSING 87% EXTENSION UNDERMOUNTED SLIDE WITH QUICK RELEASE HANDLE

**厚度** 1.4/1.4mm **Thickness** 1.4/1.4mm  
**规格** 250-450mm **Specification** 250-450mm  
**材质** 镀锌板(SGCC) **Material** Galvanized steel(SGCC)

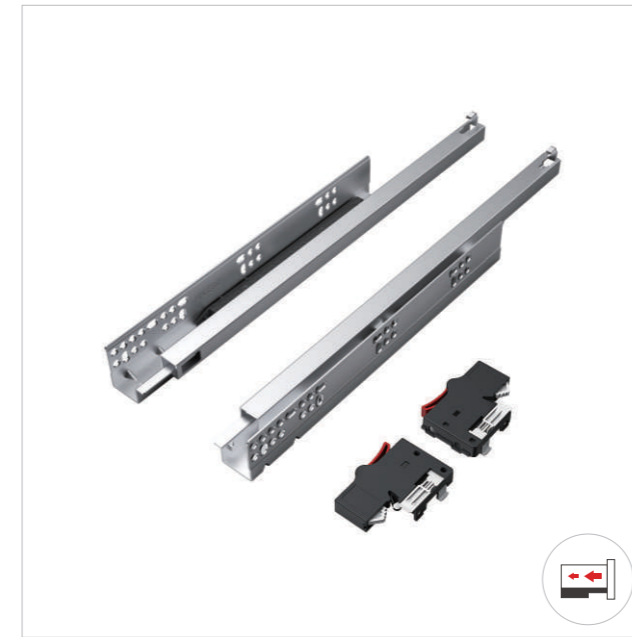

## 20101B/21101B



- 特点**
1. 隐藏式、抽屉半拉出
  2. 抽屉拆装快捷、简便、运行顺畅
  3. 抽屉上下调节量：0~3MM
  4. 动态载重：25KG

- Advantage**
1. Single extension undermounted slide
  2. Easily installed and uninstalled, smooth running
  3. Up and down adjustment: 0-3mm
  4. Loading capacity: 25KGS

**名称** 半拉出二节(阻尼)隐藏轨 把手款  
**Name** (SOFT CLOSING) SINGLE EXTENSION UNDERMOUNTED SLIDE WITH QUICK RELEASE HANDLE

**厚度** 1.4/1.4mm **Thickness** 1.4/1.4mm  
**规格** 250-550mm **Specification** 250-550mm  
**材质** 镀锌板(SGCC) **Material** Galvanized steel(SGCC)



## 20101FA/21101FA



- 特点**
1. 隐藏式、抽屉拉出7/8
  2. 抽屉拆装快捷、简便、运行顺畅
  3. 抽屉上下调节量：0~3MM
  4. 动态载重：20KG

- Advantage**
1. 87% extension undermounted slide
  2. Easily installed and uninstalled, smooth running
  3. Up and down adjustment: 0-3mm
  4. Loading capacity: 20KGS

**名称** 7/8拉出二节阻尼隐藏轨 调整钉插销款  
**Name** 2 FOLD SOFT CLOSING 87% EXTENSION UNDERMOUNTED SLIDE WITH ADJUSTABLE PIN

**厚度** 1.4/1.4mm **Thickness** 1.4/1.4mm  
**规格** 250-450mm **Specification** 250-450mm  
**材质** 镀锌板(SGCC) **Material** Galvanized steel(SGCC)



## 20104B/21104B



- 特点**
1. 隐藏式、抽屉半拉出
  2. 抽屉拆装快捷、简便、运行顺畅
  3. 抽屉上下调节量：0~3MM
  4. 动态载重：25KG

- Advantage**
1. Single extension undermounted slide
  2. Easily installed and uninstalled, smooth running
  3. Up and down adjustment: 0-3mm
  4. Loading capacity: 25KGS

**名称** 半拉出二节(触弹)隐藏轨 把手款  
**Name** (PUSH OPEN) SINGLE EXTENSION UNDERMOUNTED SLIDE WITH QUICK RELEASE HANDLE

**厚度** 1.0/1.4/1.8mm **Thickness** 1.0/1.4/1.8mm  
**规格** 250-550mm **Specification** 250-550mm  
**材质** 镀锌板(SGCC) **Material** Galvanized steel(SGCC)

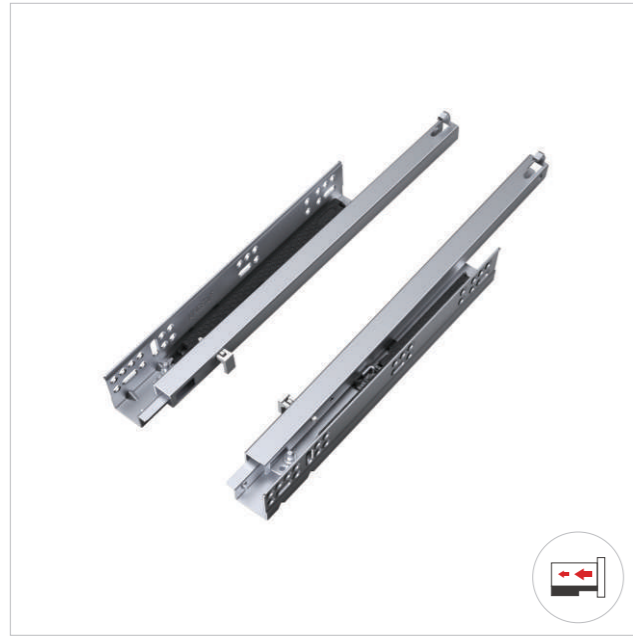

名称 半拉出二节(阻尼)隐藏轨 调整钉插销款  
Name (SOFT CLOSING) SINGLE EXTENSION UNDERMOUNTED SLIDE WITH ADJUSTABLE PIN

## 20101A/21101A



- 特点**
1. 隐藏式、抽屉半拉出
  2. 抽屉拆装快捷、简便、运行顺畅
  3. 抽屉上下调节量: 0~3MM
  4. 动态载重: 25KG

- Advantage**
1. Single extension undermounted slide
  2. Easily installed and uninstalled, smooth running
  3. Up and down adjustment: 0-3mm
  4. Loading capacity: 25KGS

|    |           |               |                        |
|----|-----------|---------------|------------------------|
| 厚度 | 1.4/1.4mm | Thickness     | 1.4/1.4mm              |
| 规格 | 250-550mm | Specification | 250-550mm              |
| 材质 | 镀锌板(SGCC) | Material      | Galvanized steel(SGCC) |



名称 半拉出二节(触弹)隐藏轨 调整钉插销款  
Name (PUSH OPEN) SINGLE EXTENSION UNDERMOUNTED SLIDE WITH ADJUSTABLE PIN

## 20104A/21104A



- 特点**
1. 隐藏式、抽屉半拉出
  2. 抽屉拆装快捷、简便、运行顺畅
  3. 抽屉上下调节量: 0~3MM
  4. 动态载重: 25KG

- Advantage**
1. Single extension undermounted slide
  2. Easily installed and uninstalled, smooth running
  3. Up and down adjustment: 0-3mm
  4. Loading capacity: 25KGS

|    |           |               |                        |
|----|-----------|---------------|------------------------|
| 厚度 | 1.4/1.4mm | Thickness     | 1.4/1.4mm              |
| 规格 | 250-550mm | Specification | 250-550mm              |
| 材质 | 镀锌板(SGCC) | Material      | Galvanized steel(SGCC) |



## B301

名称 1D把手  
Name 1D HANDLE

特点 1D调上下  
Advantage Up and down adjustment



## B302

名称 2D把手  
Name 2D HANDLE

特点 2D调上下、左右  
Advantage Up and down, left and right adjustment



## B303

名称 3D把手  
Name 3D HANDLE

特点 3D调上下、左右、前后  
Advantage Up and down, left and right, front and back adjustment

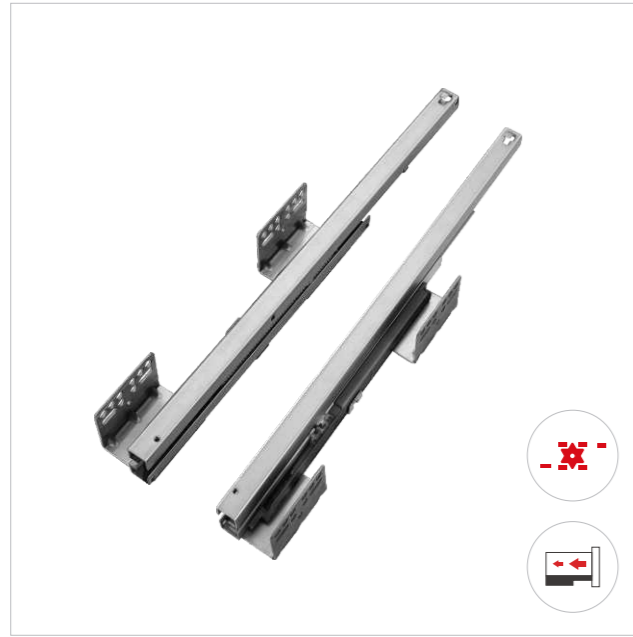

### YT201642



- 特点**
- 1.侧装式、全拉式拉篮滑轨
  - 2.拉篮运行顺畅、开合轻柔
  - 3.上轨和下轨联动运行
  - 4.动态载重：35KG
  - 5.多孔安装，受力均衡
- Advantage**
- 1.Side mounted, full extension wire baseket slide
  - 2.Smooth running, soft opening and closing
  - 3.The top slide and bottom slide run synchronously
  - 4.Loading capacity: 35KGS
  - 5.Multihole installation, force balance

名称 三节侧装拉篮轨  
Name FULL EXTENSION SIDE MOUNTED WIRE BASKET SLIDE

料厚 1.4/1.4/1.8mm Thickness 1.4/1.4/1.8mm  
规格 480mm Specification 480mm  
材质 镀锌板(SGCC) Material Galvanized steel(SGCC)

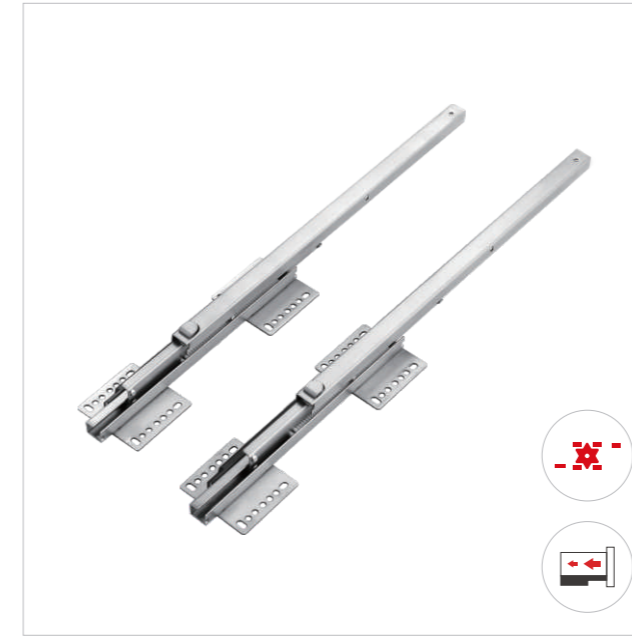

### YT2018FJ



- 特点**
- 1.顶装式、全拉式拉篮滑轨
  - 2.拉篮运行顺畅、开合轻柔
  - 3.上轨和下轨联动运行
  - 4.动态载重：35KG
  - 5.多孔安装，受力均衡
- Advantage**
- 1.Top mounted, full extension wire baseket slide
  - 2.Smooth running, soft opening and closing
  - 3.The top slide and bottom slide run synchronously
  - 4.Loading capacity: 35KGS
  - 5.Multihole installation, force balance

名称 三节顶装拉篮轨  
Name FULL EXTENSION TOP MOUNTED WIRE BASKET SLIDE

料厚 1.4/1.4/1.8mm Thickness 1.4/1.4/1.8mm  
规格 480mm Specification 480mm  
材质 镀锌板(SGCC) Material Galvanized steel(SGCC)

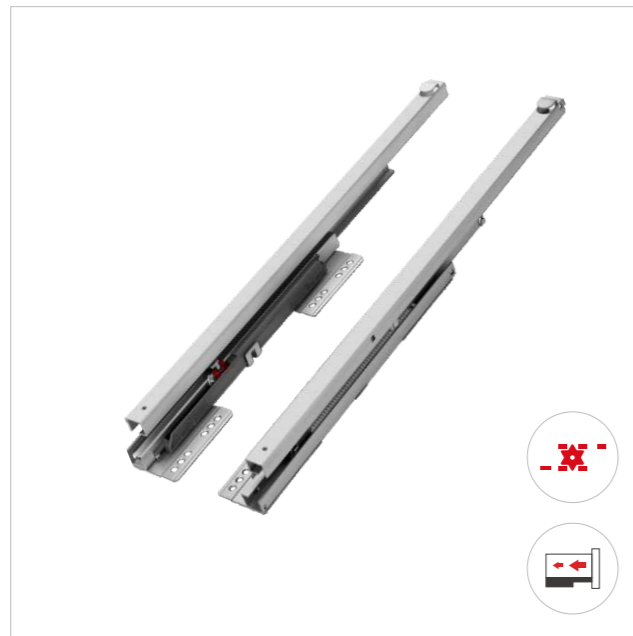

### YT2019D



- 特点**
- 1.底装式、全拉式拉篮滑轨
  - 2.拉篮运行顺畅、开合轻柔
  - 3.上轨和下轨联动运行
  - 4.动态载重：35KG
  - 5.双向孔位，安装灵活性更好
- Advantage**
- 1.Under mounted, full extension wire baseket slide
  - 2.Smooth running, soft opening and closing
  - 3.The top slide and bottom slide run synchronously
  - 4.Loading capacity: 35KGS
  - 5.Bidirection mounting hole, better installation flexibility

名称 三节底装拉篮轨  
Name FULL EXTENSION UNDER MOUNTED WIRE BASKET SLIDE

料厚 1.4/1.4/1.8mm Thickness 1.4/1.4/1.8mm  
规格 480mm Specification 480mm  
材质 镀锌板(SGCC) Material Galvanized steel(SGCC)



# G6 QUADRO UNDERMOUNTED SLIDE SERIES

G6 隐藏轨系统



G6隐藏轨系列(全拉)

G6 QUADRO UNDERMOUNTED SLIDE SERIES (FULL EXTENSION)



G6隐藏轨系列(半拉)

G6 QUADRO UNDERMOUNTED SLIDE SERIES (SINGLE EXTENSION)



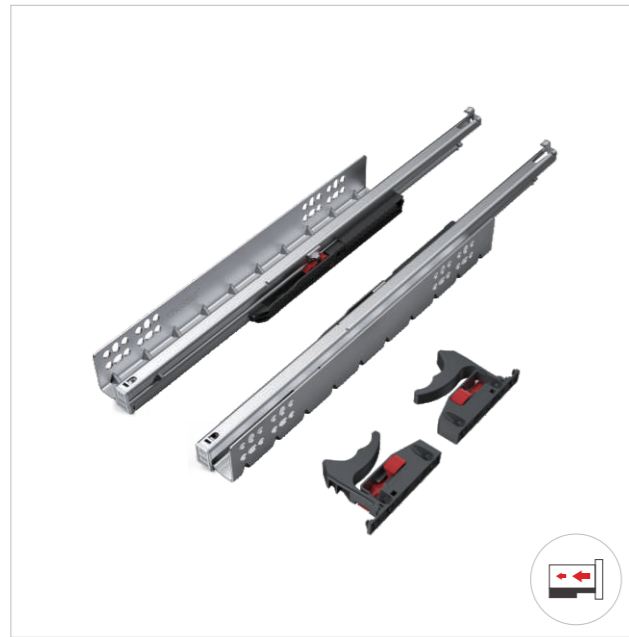

## G6311B/G6411B



- 特点**
1. 隐藏式、全拉式滑轨
  2. 抽屉运行顺畅、开合轻柔
  3. 抽屉拆装快捷、简便
  4. 抽屉上下调节量: 0~3mm
  5. 动态载重: 35KG

- Advantage**
1. Full extension undermounted slide
  2. Smooth running, soft opening and closing
  3. Easily installed and uninstalled
  4. Up and down adjustment: 0-3mm
  5. Loading capacity: 35KGS

**名称** 三节轻奢滚珠阻尼隐藏轨 (把手款)  
**Name** FULL EXTENSION SOFT CLOSING QUADRO UNDERMOUNTED SLIDE WITH QUICK RELEASE HANDLE

**厚度** 1.4/1.4/1.4mm **Thickness** 1.4/1.4/1.4mm  
**规格** 250-550mm **Specification** 250-550mm  
**材质** 镀锌板(SGCC) **Material** Galvanized steel(SGCC)



## G6311A/G6411A



- 特点**
1. 隐藏式、全拉式滑轨
  2. 抽屉运行顺畅、开合轻柔
  3. 抽屉拆装快捷、简便
  4. 抽屉上下调节量: 0~3mm
  5. 动态载重: 35KG

- Advantage**
1. Full extension undermounted slide
  2. Smooth running, soft opening and closing
  3. Easily installed and uninstalled
  4. Up and down adjustment: 0-3mm
  5. Loading capacity: 35KGS

**名称** 三节轻奢滚珠阻尼隐藏轨 (调整钉款)  
**Name** ADJUST PIN FULL EXTENSION SOFT CLOSING QUADRO UNDERMOUNTED SLIDE

**厚度** 1.4/1.4/1.4mm **Thickness** 1.4/1.4/1.4mm  
**规格** 250-550mm **Specification** 250-550mm



## G6312B/G6412B



- 特点**
1. 隐藏式、全拉式滑轨
  2. 抽屉运行顺畅、开合轻柔
  3. 抽屉拆装快捷、简便
  4. 抽屉上下调节量: 0~3mm
  5. 动态载重: 35KG

- Advantage**
1. Full extension undermounted slide
  2. Smooth running, soft opening and closing
  3. Easily installed and uninstalled
  4. Up and down adjustment: 0-3mm
  5. Loading capacity: 35KGS

**名称** 三节轻奢滚珠触弹隐藏轨 (把手款)  
**Name** FULL EXTENSION PUSH OPEN QUADRO UNDERMOUNTED SLIDE WITH THE QUICK RELEASE HANDLE

**厚度** 1.4/1.4/1.4mm **Thickness** 1.4/1.4/1.4mm  
**规格** 250-550mm **Specification** 250-550mm  
**材质** 镀锌板(SGCC) **Material** Galvanized steel(SGCC)



## G6312A/G6412A



- 特点**
1. 隐藏式、全拉式滑轨
  2. 抽屉运行顺畅、开合轻柔
  3. 抽屉拆装快捷、简便
  4. 抽屉上下调节量: 0~3mm
  5. 动态载重: 35KG

- Advantage**
1. Full extension undermounted slide
  2. Smooth running, soft opening and closing
  3. Easily installed and uninstalled
  4. Up and down adjustment: 0-3mm
  5. Loading capacity: 35KGS

**名称** 三节轻奢滚珠触弹隐藏轨 (调整钉款)  
**Name** ADJUST PIN FULL EXTENSION PUSH OPEN QUADRO UNDERMOUNTED SLIDE

**厚度** 1.4/1.4/1.4mm **Thickness** 1.4/1.4/1.4mm  
**规格** 250-550mm **Specification** 250-550mm



G6211B



- 特点**
1. 隐藏式、三分之二拉出
  2. 抽屉运行顺畅、开合轻柔
  3. 抽屉拆装快捷、简便
  4. 抽屉上下调节量: 0~3mm
  5. 动态载重: 25KG
- Advantage**
1. 2/3 extension undermounted slide
  2. Smooth running, soft opening and closing
  3. Easily installed and uninstalled
  4. Up and down adjustment: 0-3mm
  5. Loading capacity: 25KGS



**名称** 二节轻奢滚珠阻尼隐藏轨 (把手款)  
**Name** SINGLE EXTENSION SOFT CLOSING QUADRO UNDERMOUNTED SLIDE WITHE QUICK RELEASE HANDLE

**厚度** 1.5/1.4mm **Thickness** 1.5/1.4mm  
**规格** 250-550mm **Specification** 250-550mm  
**材质** 镀锌板(SGCC) **Material** Galvanized steel(SGCC)



G6211A



- 特点**
1. 隐藏式、三分之二拉出
  2. 抽屉运行顺畅、开合轻柔
  3. 抽屉拆装快捷、简便
  4. 抽屉上下调节量: 0~3mm
  5. 动态载重: 25KG
- Advantage**
1. 2/3 extension undermounted slide
  2. Smooth running, soft opening and closing
  3. Easily installed and uninstalled
  4. Up and down adjustment: 0-3mm
  5. Loading capacity: 25KGS



**名称** 二节轻奢滚珠阻尼隐藏轨 (调整钉款)  
**Name** ADJUST PIN SINGLE EXTENSION SOFT CLOSING QUADRO UNDERMOUNTED SLIDE

**厚度** 1.5/1.4mm **Thickness** 1.5/1.4mm  
**规格** 250-550mm **Specification** 250-550mm  
**材质** 镀锌板(SGCC) **Material** Galvanized steel(SGCC)



G6212B



- 特点**
1. 隐藏式、三分之二拉出
  2. 抽屉运行顺畅、开合轻柔
  3. 抽屉拆装快捷、简便
  4. 抽屉上下调节量: 0~3mm
  5. 动态载重: 25KG
- Advantage**
1. 2/3 extension undermounted slide
  2. Smooth running, soft opening and closing
  3. Easily installed and uninstalled
  4. Up and down adjustment: 0-3mm
  5. Loading capacity: 25KGS



**名称** 二节轻奢滚珠触弹隐藏轨 (把手款)  
**Name** SINGLE EXTENSION PUSH OPEN QUADRO UNDERMOUNTED SLIDE WITHE QUICK RELEASE HANDLE

**厚度** 1.5/1.4mm **Thickness** 1.5/1.4mm  
**规格** 250-550mm **Specification** 250-550mm  
**材质** 镀锌板(SGCC) **Material** Galvanized steel(SGCC)



G6212A



- 特点**
1. 隐藏式、三分之二拉出
  2. 抽屉运行顺畅、开合轻柔
  3. 抽屉拆装快捷、简便
  4. 抽屉上下调节量: 0~3mm
  5. 动态载重: 25KG
- Advantage**
1. 2/3 extension undermounted slide
  2. Smooth running, soft opening and closing
  3. Easily installed and uninstalled
  4. Up and down adjustment: 0-3mm
  5. Loading capacity: 25KGS



**名称** 二节轻奢滚珠触弹隐藏轨 (调整钉款)  
**Name** ADJUST PIN SINGLE EXTENSION PUSH OPEN QUADRO UNDERMOUNTED SLIDE

**厚度** 1.5/1.4mm **Thickness** 1.5/1.4mm  
**规格** 250-550mm **Specification** 250-550mm  
**材质** 镀锌板(SGCC) **Material** Galvanized steel(SGCC)

# BALL BEARING SLIDE SERIES

钢珠轨系列



防倾倒滑轨系列  
ANTI-TIPPING SLIDE SERIES



钢珠轨系列  
BALL BEARING SLIDE SERIES





## 4530PT/4605PT(加厚)



- 特点**
- 1.带防倾倒装置三节钢珠轨
  - 2.抽屉全拉出，一抽屉拉出其它便紧闭
  - 3.表面处理：锌色/黑色
  - 4.抽屉运行顺畅、开合轻柔
  - 5.动态载重:40KG/45KG (加厚)
- Advantage**
- 1.Anti-tipping 3-fold ball bearing slide
  - 2.Full extension, once a drawer is pulled out, the others are locked
  - 3.Finish: Zinc/Black
  - 4.Smooth running, soft opening and closing
  - 5.Loading capacity: 40KGS/45KGS (thickened)

名称 防倾倒H45三节钢珠轨  
Name ANTI-TIPPING H45MM BALL BEARING SLIDE

|    |                                    |               |   |
|----|------------------------------------|---------------|---|
| 料厚 | 1.0/1.0/1.2mm<br>1.2/1.2/1.4mm(加厚) | Thickness     | 1.0/1.0/1.2mm<br>1.2/1.2/1.4mm(thicken) |
| 规格 | 250-550mm                          | Specification | 250-550mm                               |
| 材质 | 镀锌板(SGCC)                          | Material      | Galvanized steel(SGCC)                  |



## 4530P2/4605P2(加厚)



- 特点**
- 1.抽屉全拉出
  - 2.表面处理：锌色/黑色
  - 3.轻触即可开启无拉手抽屉
  - 4.抽屉拆装快捷、简便
  - 5.动态载重:35KG/40KG (加厚)
- Advantage**
- 1.Full extension
  - 2.Finish: Zinc/Black
  3. Just with a slight push , the drawer can be opened, no need handle
  - 4.Easily installed and uninstalled
  - 5.Loading capacity: 35KGS/40KGS (thickened)

名称 H45 三节反弹钢珠轨  
Name H45MM PUSH TO OPEN BALL BEARING SLIDE

|    |                                    |               |   |
|----|------------------------------------|---------------|---|
| 料厚 | 1.0/1.0/1.2mm<br>1.2/1.2/1.4mm(加厚) | Thickness     | 1.0/1.0/1.2mm<br>1.2/1.2/1.4mm(thicken) |
| 规格 | 250-600mm                          | Specification | 250-600mm                               |
| 材质 | Q235                               | Material      | Q235                                    |

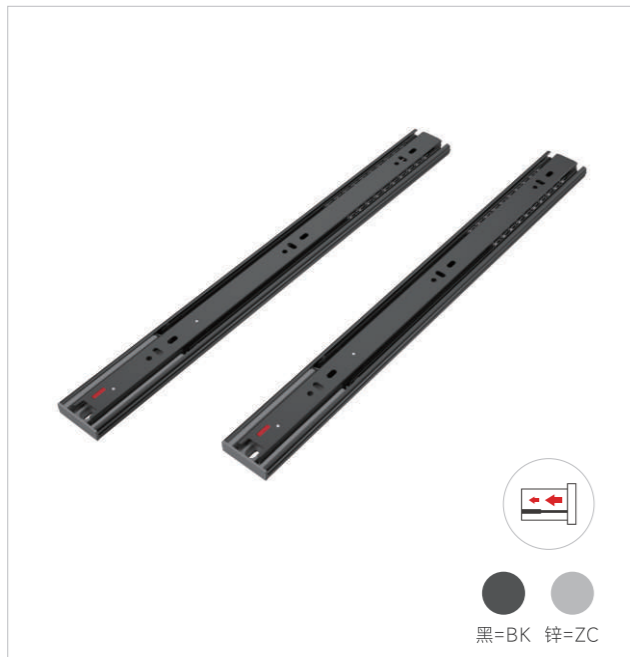

## 4530S2/4605S2(加厚)



- 特点**
- 1.抽屉全拉出
  - 2.表面处理：锌色/黑色
  - 3.抽屉运行顺畅、开合轻柔
  - 4.抽屉拆装快捷、简便
  - 5.动态载重：35KG/40KG (加厚)
- Advantage**
- 1.Full extension
  - 2.Finish: Zinc/Black
  - 3.Smooth running, soft opening and closing
  - 4.Easily installed and uninstalled
  - 5.Loading capacity: 35KGS/40KGS (thickened)

名称 H45 三节阻尼钢珠轨  
Name H45MM SOFT CLOSING BALL BEARING SLIDE

|    |                                    |               |   |
|----|------------------------------------|---------------|---|
| 料厚 | 1.0/1.0/1.2mm<br>1.2/1.2/1.4mm(加厚) | Thickness     | 1.0/1.0/1.2mm<br>1.2/1.2/1.4mm(thicken) |
| 规格 | 250-600mm                          | Specification | 250-600mm                               |
| 材质 | Q235                               | Material      | Q235                                    |



## 4530/4605(加厚)



- 特点**
- 1.抽屉全拉出
  - 2.表面处理：锌色/黑色
  - 3.抽屉运行顺畅、开合轻柔
  - 4.抽屉拆装快捷、简便
  - 5.动态载重:40KG/45KG (加厚)
- Advantage**
- 1.Full extension
  - 2.Finish: Zinc/Black
  - 3.Smooth running, soft opening and closing
  - 4.Easily installed and uninstalled
  - 5.Loading capacity: 40KGS/45KGS (thickened)

名称 H45 三节钢珠轨  
Name H45MM BALL BEARING SLIDE

|    |                                    |               |   |
|----|------------------------------------|---------------|---|
| 料厚 | 1.0/1.0/1.2mm<br>1.2/1.2/1.4mm(加厚) | Thickness     | 1.0/1.0/1.2mm<br>1.2/1.2/1.4mm(thicken) |
| 规格 | 250-600mm                          | Specification | 250-600mm                               |
| 材质 | Q235                               | Material      | Q235                                    |



### 3505S



- 特点**
- 1.抽屉全拉出
  - 2.表面处理: 锌色/黑色
  - 3.抽屉运行顺畅、开合轻柔
  - 4.抽屉拆装快捷、简便
  - 5.动态载重:25KG
- Advantage**
- 1.Full extension
  - 2.Finish: Zinc/Black
  - 3.Smooth running, soft opening and closing
  - 4.Easily installed and uninstalled
  - 5.Loading capacity: 25KGS

名称 H35 三节阻尼钢珠轨  
Name H35MM SOFT CLOSING BALL BEARING SLIDE

料厚 1.0/1.0/1.2mm Thickness 1.0/1.0/1.2mm  
规格 250-600mm Specification 250-600mm  
材质 Q235 Material Q235



### 3505



- 特点**
- 1.抽屉全拉出
  - 2.表面处理: 锌色/黑色
  - 3.抽屉运行顺畅、开合轻柔
  - 4.抽屉拆装快捷、简便
  - 5.动态载重:30KG
- Advantage**
- 1.Full extension
  - 2.Finish: Zinc/Black
  - 3.Smooth running, soft opening and closing
  - 4.Easily installed and uninstalled
  - 5.Loading capacity: 30KGS

名称 H35 三节普通钢珠轨  
Name H35MM BALL BEARING SLIDE

料厚 1.0/1.0/1.2mm Thickness 1.0/1.0/1.2mm  
规格 250-600mm Specification 250-600mm  
材质 Q235 Material Q235



### 2703



- 特点**
- 1.抽屉半拉出
  - 2.表面处理: 锌色/黑色
  - 3.抽屉运行顺畅、开合轻柔
  - 4.抽屉拆装快捷、简便
  - 5.动态载重:15KG
- Advantage**
- 1.Single extension
  - 2.Finish: Zinc/Black
  - 3.Smooth running, soft opening and closing
  - 4.Easily installed and uninstalled
  - 5.Loading capacity: 15KGS

名称 H27 二节普通钢珠轨  
Name H27MM SINGLE EXTENSION BALL BEARING SLIDE

料厚 1.0/1.0mm Thickness 1.0/1.0mm  
规格 250-600mm Specification 250-600mm  
材质 Q235 Material Q235



### ES3500

名称 H35 美式滑轨后托  
Name H35MM END SOCKET



### ES4500

名称 H45 美式滑轨后托  
Name H45MM END SOCKET



# HEAVY DUTY SLIDE SERIES

重型軌系列



重型滑軌  
HEAVY DUTY BALL BEARING SLIDE





7601Z



- 特点**
- 1.带双向锁定功能
  - 2.抽屉全拉出
  - 3.表面处理：锌色/黑色
  - 4.不可拆分安装功能
  - 5.动态载重：220KG
- Advantage**
- 1.With bidirectional locking function
  - 2.Full extension
  - 3.Finish: Zinc/Black
  - 4.The inner rail can not be splitted and installed
  - 5.Loading capacity: 220KGS

名称 H76 三节带锁重型滑轨

Name H76MM HEAVY DUTY FULL EXTENSION BALL BEARING SLIDE WITH LOCK

料厚 2.5/2.2/2.5mm Thickness 2.5/2.2/2.5mm

规格 254-2032mm Specification 254-2032mm

材质 Q235 Material Q235



5301Z



- 特点**
- 1.带双向锁定功能
  - 2.抽屉全拉出
  - 3.表面处理：锌色/黑色
  - 4.不可拆分安装功能
  - 5.动态载重：110KG
- Advantage**
- 1.With bidirectional locking function
  - 2.Full extension
  - 3.Finish: Zinc/Black
  - 4.The inner rail can not be splitted and installed
  - 5.Loading capacity: 110KGS

名称 H53 三节带锁重型滑轨

Name H53MM HEAVY DUTY FULL EXTENSION BALL BEARING SLIDE WITH LOCK

料厚 2.0mm Thickness 2.0mm

规格 250-1800mm Specification 250-1800mm

材质 Q235 Material Q235



7601



- 特点**
- 1.抽屉全拉出
  - 2.表面处理：锌色/黑色
  - 3.不可拆分安装功能
  - 4.动态载重：220KG
- Advantage**
- 1.Full extension
  - 2.Finish: Zinc/Black
  - 3.The inner rail can not be splitted and installed
  - 4.Loading capacity: 220KGS

名称 H76 三节普通重型滑轨

Name H76MM HEAVY DUTY FULL EXTENSION BALL BEARING SLIDE

料厚 2.5/2.2/2.5mm Thickness 2.5/2.2/2.5mm

规格 254-2032mm Specification 254-2032mm

材质 Q235 Material Q235



5301S



- 特点**
- 1.带防夹阻尼功能
  - 2.抽屉全拉出
  - 3.表面处理：锌色/黑色
  - 4.可拆分安装功能
  - 5.动态载重：110KG
- Advantage**
- 1.With anti-pinch damping function
  - 2.Full extension
  - 3.Finish: Zinc/Black
  - 4.The inner rail can be splitted and installed
  - 5.Loading capacity: 110KGS

名称 H53 三节阻尼重型滑轨

Name H53MM HEAVY DUTY SOFT CLOSING FULL EXTENSION BALL BEARING SLIDE

料厚 2.0mm Thickness 2.0mm

规格 250-1800mm Specification 250-1800mm

材质 Q235 Material Q235





## 5301



- 特点**
1. 抽屉全拉出
  2. 表面处理：锌色/黑色
  3. 可拆分安装功能
  4. 动态载重：110KG

- Advantage**
1. Full extension
  2. Finish: Zinc/Black
  3. The inner rail can be splitted and installed
  4. Loading capacity: 110KGS

名称 H53 三节普通重型滑轨

Name H53MM HEAVY DUTY FULL EXTENSION BALL BEARING SLIDE

料厚 2.0mm

规格 250-1800mm

材质 Q235

Thickness 2.0mm

Specification 250-1800mm

Material Q235



## 5101Z



- 特点**
1. 带双向锁定功能
  2. 抽屉全拉出
  3. 表面处理：锌色/黑色
  4. 不可拆分安装功能
  5. 动态载重：60KG

- Advantage**
1. With bidirectional locking function
  2. Full extension
  3. Finish: Zinc/Black
  4. The inner rail can not be splitted and installed
  5. Loading capacity: 60KGS

名称 H51 三节带锁重型滑轨

Name H51MM HEAVY DUTY FULL EXTENSION BALL BEARING SLIDE WITH LOCK

料厚 1.5/1.5/1.5mm

规格 250-1000mm

材质 Q235

Thickness 1.5/1.5/1.5mm

Specification 250-1000mm

Material Q235

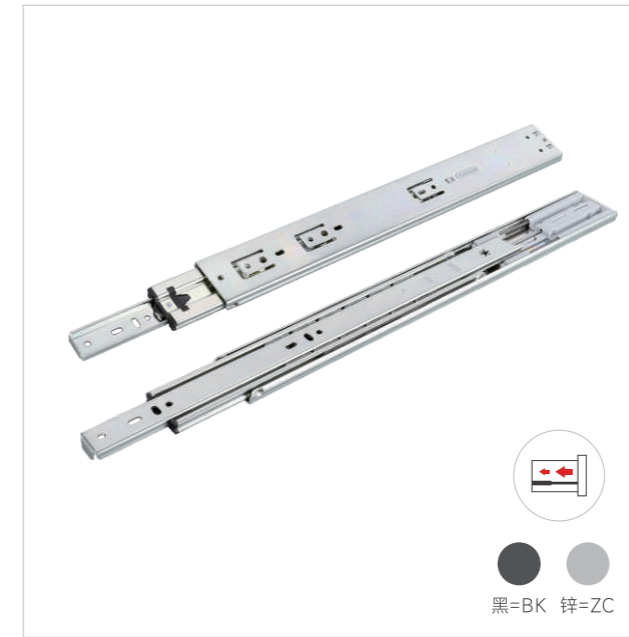

## 5101S



- 特点**
1. 带防夹阻尼功能
  2. 抽屉全拉出
  3. 表面处理：锌色/黑色
  4. 可拆分安装功能
  5. 动态载重：60KG

- Advantage**
1. With anti-pinch damping function
  2. Full extension
  3. Finish: Zinc/Black
  4. The inner rail can be splitted and installed
  5. Loading capacity: 60KGS

名称 H51 三节阻尼重型滑轨

Name H51MM HEAVY DUTY SOFT CLOSING FULL EXTENSION BALL BEARING SLIDE

料厚 1.5/1.5/1.5mm

规格 250-1000mm

材质 Q235

Thickness 1.5/1.5/1.5mm

Specification 250-1000mm

Material Q235

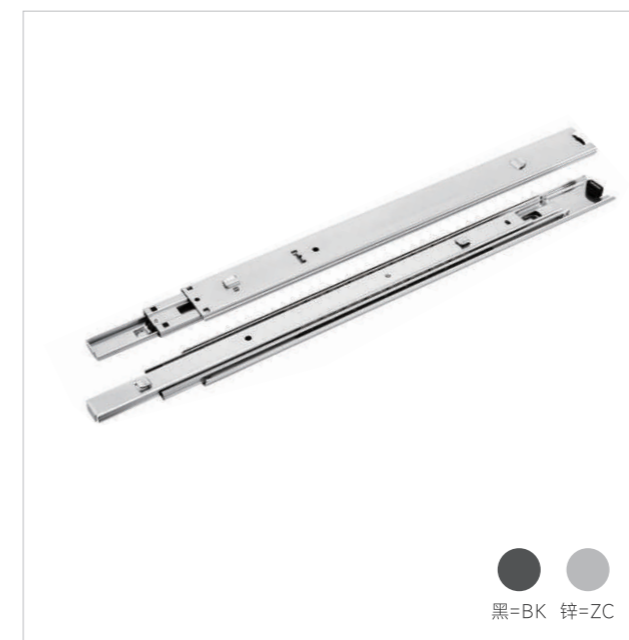

## 5101



- 特点**
1. 抽屉全拉出
  2. 表面处理：锌色/黑色
  3. 可拆分安装功能
  4. 动态载重：60KG

- Advantage**
1. Full extension
  2. Finish: Zinc/Black
  3. The inner rail can be splitted and installed
  4. Loading capacity: 60KGS

名称 H51 三节铁柜重型滑轨

Name H51MM METAL DRAWER HEAVY DUTY FULL EXTENSION BALL BEARING SLIDE

料厚 1.5/1.5/1.5mm

规格 250-1000mm

材质 Q235

Thickness 1.5/1.5/1.5mm

Specification 250-1000mm

Material Q235

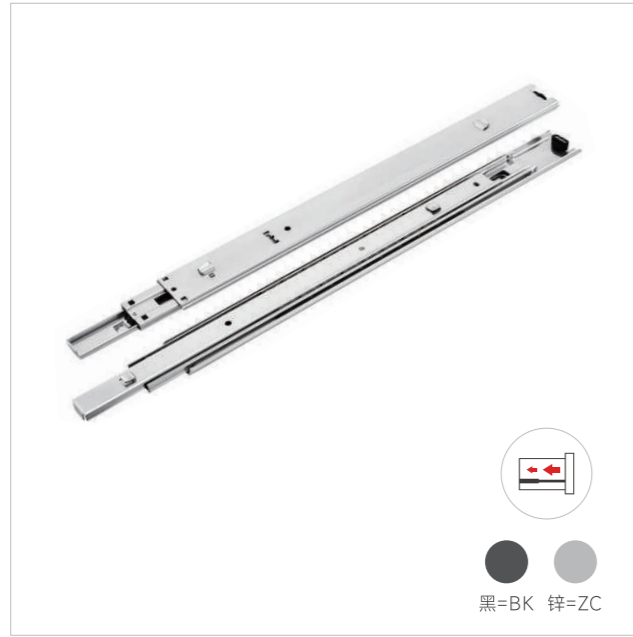

## 5001



### 特点

- 1.抽屜全拉出
- 2.表面处理: 锌色/黑色
- 3.可拆分安装功能
- 4.动态载重: 60KG

### Advantage

- 1.Full extension
- 2.Finish: Zinc/Black
- 3.The inner rail can be splitted and installed
- 4.Loading capacity: 60KGS

名称 H50 三节铁柜重型滑轨

Name H50MM METAL DRAWER HEAVY DUTY FULL EXTENSION BALL BEARING SLIDE

料厚 1.5/1.5/1.5mm

Thickness 1.5/1.5/1.5mm

规格 250-1000mm

Specification 250-1000mm

材质 Q235

Material Q235



## 5002



### 特点

- 1.抽屜全拉出
- 2.表面处理: 锌色/黑色
- 3.可拆分安装功能
- 4.动态载重: 60KG

### Advantage

- 1.Full extension
- 2.Finish: Zinc/Black
- 3.The inner rail can be splitted and installed
- 4.Loading capacity: 60KGS

名称 H50 三节普通重型滑轨

Name H50MM HEAVY DUTY FULL EXTENSION BALL BEARING SLIDE

料厚 1.5/1.5/1.5mm

Thickness 1.5/1.5/1.5mm

规格 250-1000mm

Specification 250-1000mm

材质 Q235

Material Q235



## 4801



### 特点

- 1.可根据客户要求订制尺寸
- 2.表面处理: 锌色/黑色
- 3.底装, 多孔定位, 安装稳固
- 4.动态载重: 100KG

### Advantage

- 1.Custom-size
- 2.Finish: Zinc/Black
- 3.Bottom mounted, multihole positioning, stable installation
- 4.Loading capacity: 100KGS

名称 H48\*51\*51 三节楼梯滑轨

Name H48\*51\*51MM STAIRWAY BALL BEARING SLIDE

料厚 2.0/2.0/2.0mm

Thickness 2.0/2.0/2.0mm

规格 600mm拉出1000/1450mm  
800mm拉出1500/1850mm  
1000mm拉出1500/1850mm

Specification 600mm Extension 1000/1450mm  
800mm Extension 1500/1850mm  
1000mm Extension 1500/1850mm

材质 Q235

Material Q235

# HINGE SERIES

铰链系列



铰链系列  
HINGE SERIES



美式铰链系列  
AMERICAN HINGE SERIES





### HS138



- 特点** 1.一次性开合，全程缓冲中间不停顿  
2.双层加厚电镀，刚劲品质加倍耐用
- Advantage** 1.One time opening and closing, no pause in the entire buffer  
2.Thickened electroplating enhances durability
- 参数** 1.开门角度：110°  
2.铰杯厚度：11.5mm  
3.面板（K值）：3-7mm  
4.适用门板（厚）：16-20mm
- Parameter** 1.Opening degree: 110°  
2.Depth of hinge cup: 11.5mm  
3.Door K dimension: 3-7mm  
4.Range of door thickness:16-20mm

名称  $\Phi$ 35 一段力缓冲铰链固装  
Name  $\Phi$ 35 FIXED ON ONE WAY HYDRAULIC BUFFERING HINGES

材质 冷轧钢 **Material** Cold rolled steel  
厚度 1.0mm **Thickness** 1.0mm



### HS136



- 特点** 1.一次性开合，全程缓冲中间不停顿  
2.双层加厚电镀，刚劲品质加倍耐用  
3.带一键拆卸，方便安装调整
- Advantage** 1.One time opening and closing, no pause in the entire buffer  
2.Thickened electroplating enhances durability  
3.Clip on hinges, easily install and adjust
- 参数** 1.开门角度：110°  
2.铰杯厚度：11.5mm  
3.面板（K值）：3-7mm  
4.适用门板（厚）：16-20mm
- Parameter** 1.Opening degree: 110°  
2.Depth of hinge cup: 11.5mm  
3.Door K dimension: 3-7mm  
4.Range of door thickness:16-20mm

名称  $\Phi$ 35 一段力缓冲铰链卡式  
Name  $\Phi$ 35 CLIP ON ONE WAY HYDRAULIC BUFFERING HINGES

材质 冷轧钢 **Material** Cold rolled steel  
厚度 1.2mm **Thickness** 1.2mm



### HS137



- 特点** 1.一次性开合，全程缓冲中间不停顿  
2.双层加厚电镀，刚劲品质加倍耐用  
3.带一键拆卸、三维调节，方便安装调整
- Advantage** 1.One time opening and closing, no pause during closing  
2.Thickened electroplating enhances durability  
3.Clip on hinges, 3D adjustment, easily install and adjust
- 参数** 1.开门角度：110°  
2.铰杯厚度：11.5mm  
3.面板（K值）：3-7mm  
4.适用门板（厚）：16-20mm
- Parameter** 1.Opening degree: 110°  
2.Depth of hinge cup: 11.5mm  
3.Door K dimension: 3-7mm  
4.Range of door thickness:16-20mm

名称  $\Phi$ 35一段力缓冲铰链卡式三维  
Name  $\Phi$ 35 CLIP ON ONE WAY 3D ADJUSTABLE HYDRAULIC BUFFERING HINGES

材质 冷轧钢 **Material** Cold rolled steel  
厚度 1.2mm **Thickness** 1.2mm



### HS238



- 特点** 1.升级二段力：护门板，防松动  
2.双层加厚电镀，刚劲品质加倍耐用  
3.45°自动闭合轻推力，轻手一推静音关门
- Advantage** 1.Upgrade two way hinges protect door panel  
2.Thickened electroplating enhances durability  
3.Close at 45° slightly and silently
- 参数** 1.开门角度：110°  
2.铰杯厚度：11.5mm  
3.面板（K值）：3-7mm  
4.适用门板（厚）：16-20mm
- Parameter** 1.Opening degree: 110°  
2.Depth of hinge cup: 11.5mm  
3.Door K dimension: 3-7mm  
4.Range of door thickness:16-20mm

名称  $\Phi$ 35二段力缓冲铰链固装  
Name  $\Phi$ 35 FIXED ON TWO WAY HYDRAULIC BUFFERING HINGES

材质 冷轧钢 **Material** Cold rolled steel  
厚度 1.0mm **Thickness** 1.0mm



HS236



- 特点**
- 1.升级二段力：护门板，防松动
  - 2.双层加厚电镀，刚劲品质加倍耐用
  - 3.45°自动闭合轻推力，轻手一推静音关门
  - 4.带一键拆卸，方便安装调整
- Advantage**
- 1.Upgrade two way hinges protect door panel
  - 2.Thickened electroplating enhances durability
  - 3.Close at 45° slightly and silently
  - 4.Clip on hinges, easily install and adjust
- 参数**
- 1.开门角度：110°
  - 2.铰杯厚度：11.5mm
  - 3.面板（K值）：3-7mm
  - 4.适用门板（厚）：16-20mm
- Parameter**
- 1.Opening degree: 110°
  - 2.Depth of hinge cup: 11.5mm
  - 3.Door K dimension: 3-7mm
  - 4.Range of door thickness: 16-20mm

名称 Φ35二段力缓冲铰链卡式  
Name Φ35 CLIP ON TWO WAY HYDRAULIC BUFFERING HINGES

材质 冷轧钢 Material Cold rolled steel  
厚度 1.2mm Thickness 1.2mm



HS237



- 特点**
- 1.升级二段力：护门板，防松动
  - 2.双层加厚电镀，刚劲品质加倍耐用
  - 3.45°自动闭合轻推力，轻手一推静音关门
  - 4.带一键拆卸、三维调节，方便安装调整
- Advantage**
- 1.Upgrade two way hinges protect door panel
  - 2.Thickened electroplating enhances durability
  - 3.Close at 45° slightly and silently
  - 4.Clip on hinges, 3D adjustment, easily install and adjust
- 参数**
- 1.开门角度：110°
  - 2.铰杯厚度：11.5mm
  - 3.面板（K值）：3-7mm
  - 4.适用门板（厚）：16-20mm
- Parameter**
- 1.Opening degree: 110°
  - 2.Depth of hinge cup: 11.5mm
  - 3.Door K dimension: 3-7mm
  - 4.Range of door thickness: 16-20mm

名称 Φ35二段力缓冲铰链卡式三维  
Name Φ35 CLIP ON TWO WAY 3D ADJUSTABLE HYDRAULIC BUFFERING HINGES

材质 冷轧钢 Material Cold rolled steel  
厚度 1.2mm Thickness 1.2mm



HS338



- 特点**
- 1.防夹手，低角度缓冲（5-10°）
  - 2.双层加厚电镀，刚劲品质加倍耐用
  - 3.45°自动闭合轻推力，轻手一推静音关门
  - 4.满足16-25mm厚板解决门厚不规则问题
- Advantage**
- 1.Anti-pinch, low angle buffering(5-10°)
  - 2.Thickened electroplating enhances durability
  - 3.Close at 45° slightly and silently
  - 4.Meet the 16-25mm thickness, solve the problem of irregular door thickness
- 参数**
- 1.开门角度：100°
  - 2.铰杯厚度：11.3mm
  - 3.面板（K值）：3-7mm
  - 4.适用门板（厚）：16-25mm
- Parameter**
- 1.Opening degree: 100°
  - 2.Depth of hinge cup: 11.3mm
  - 3.Door K dimension: 3-7mm
  - 4.Range of door thickness: 16-25mm

名称 Φ35 小角度厚门缓冲铰链固装  
Name Φ35 SMALL ANGLE FIXED ON THICK DOOR (16-25mm) HYDRAULIC BUFFERING HINGES

材质 冷轧钢 Material Cold rolled steel  
厚度 1.0mm Thickness 1.0mm



HS336



- 特点**
- 1.防夹手，低角度缓冲（5-10°）
  - 2.双层加厚电镀，刚劲品质加倍耐用
  - 3.45°自动闭合轻推力，轻手一推静音关门
  - 4.满足16-25mm厚板解决门厚不规则问题
- Advantage**
- 1.Anti-pinch, low angle buffering(5-10°)
  - 2.Thickened electroplating enhances durability
  - 3.Close at 45° slightly and silently
  - 4.Meet the 16-25mm thickness, solve the problem of irregular door thickness
- 参数**
- 1.开门角度：100°
  - 2.铰杯厚度：11.3mm
  - 3.面板（K值）：3-7mm
  - 4.适用门板（厚）：16-25mm
- Parameter**
- 1.Opening degree: 100°
  - 2.Depth of hinge cup: 11.3mm
  - 3.Door K dimension: 3-7mm
  - 4.Range of door thickness: 16-25mm

名称 Φ35 小角度厚门缓冲铰链卡式二维  
Name Φ35 SMALL ANGLE CLIP ON 2D ADJUSTABLE THICK DOOR (16-25mm) HYDRAULIC BUFFERING HINGES

材质 冷轧钢 Material Cold rolled steel  
厚度 1.2mm Thickness 1.2mm



### HS337



- 特点**
- 1.防夹手，低角度缓冲 (5-10°)
  - 2.双层加厚电镀，刚劲品质加倍耐用
  - 3.45°自动闭合轻推力，轻手一推静音关门
  - 4.满足16-25mm厚板解决门厚不规则问题
  - 5.带一键拆卸、三维调节，方便安装调整
- Advantage**
- 1.Anti-pinch, low angle buffering(5-10°)
  - 2.Thickened electroplating enhances durability
  - 3.Close at 45° slightly and silently
  - 4.Meet the 16-25mm thickness, solve the problem of irregular door thickness
  - 5.Clip on hinges, 3D adjustment, easily install and adjust
- 参数**
- 1.开门角度：100°
  - 2.铰杯厚度：11.3mm
  - 3.面板 (K值)：3-7mm
  - 4.适用门板 (厚)：16-25mm
- Parameter**
- 1.Opening degree: 100°
  - 2.Depth of hinge cup: 11.3mm
  - 3.Door K dimension: 3-7mm
  - 4.Range of door thickness: 16-25mm

名称  $\Phi$ 35 小角度厚门缓冲铰链卡式三维  
Name  $\Phi$ 35 SMALL ANGLE CLIP ON 3D ADJUSTABLE THICK DOOR (16-25mm) HYDRAULIC BUFFERING HINGES

|    |       |           |                   |
|----|-------|-----------|-------------------|
| 材质 | 冷轧钢   | Material  | Cold rolled steel |
| 厚度 | 1.2mm | Thickness | 1.2mm             |



### HS243



- 特点**
- 1.升级二段力：护门板，防松动
  - 2.双层加厚电镀，刚劲品质加倍耐用
  - 3.45°自动闭合轻推力，轻手一推静音关门
  - 4.带一键拆卸、三维调节，方便安装调整
- Advantage**
- 1.Upgrade two way hinges protect door panel
  - 2.Thickened electroplating enhances durability
  - 3.Close at 45° slightly and silently
  - 4.Clip on hinges, 3D adjustment, easily install and adjust
- 参数**
- 1.开门角度：110°
  - 2.铝框铰杯钻孔：28mm
  - 3.铝型材V宽度：19-23mm
- Parameter**
- 1.Opening degree: 110°
  - 2.Hinge cup drilling dimension: 28mm
  - 3.Aluminum profile V width: 19-23mm

名称  $\Phi$ 28 铝框门缓冲铰链卡式三维  
Name  $\Phi$ 28 CLIP ON 3D ADJUSTABLE ALUMINUM FRAME DOOR HYDRAULIC BUFFERING HINGES

|    |       |           |                   |
|----|-------|-----------|-------------------|
| 材质 | 冷轧钢   | Material  | Cold rolled steel |
| 厚度 | 1.2mm | Thickness | 1.2mm             |



### HS239



- 特点**
- 1.升级二段力：护门板，防松动
  - 2.双层加厚电镀，刚劲品质加倍耐用
  - 3.45°自动闭合轻推力，轻手一推静音关门
- Advantage**
- 1.Upgrade two way hinges protect door panel
  - 2.Thickened electroplating enhances durability
  - 3.Close at 45° slightly and silently
- 参数**
- 1.开门角度：110°
  - 2.铝框铰杯钻孔：28mm
  - 3.铝型材V宽度：19-23mm
- Parameter**
- 1.Opening degree: 110°
  - 2.Hinge cup drilling dimension: 28mm
  - 3.Aluminum profile V width: 19-23mm

名称  $\Phi$ 28 铝框门缓冲铰链固装  
Name  $\Phi$ 28 FIXED ON ALUMINUM FRAME DOOR HYDRAULIC BUFFERING HINGES

|    |       |           |                   |
|----|-------|-----------|-------------------|
| 材质 | 冷轧钢   | Material  | Cold rolled steel |
| 厚度 | 1.0mm | Thickness | 1.0mm             |



### HS045



- 特点**
- 1.一次性开合，全程缓冲中间不停顿
  - 2.双层加厚电镀，刚劲品质加倍耐用
- Advantage**
- 1.One time opening and closing, no pause in the entire buffer
  - 2.Thickened electroplating enhances durability
- 参数**
- 1.开门角度：45°
  - 2.铰杯厚度：11.5mm
  - 3.面板 (K值)：3-7mm
  - 4.适用门板 (厚)：14-24mm
- Parameter**
- 1.Opening degree: 45°
  - 2.Depth of hinge cup: 11.5mm
  - 3.Door K dimension: 3-7mm
  - 4.Range of door thickness: 14-24mm

名称  $\Phi$ 35 45°角度缓冲铰链固装  
Name  $\Phi$ 35 45° FIXED ON HYDRAULIC BUFFERING HINGES

|    |       |           |                   |
|----|-------|-----------|-------------------|
| 材质 | 冷轧钢   | Material  | Cold rolled steel |
| 厚度 | 1.2mm | Thickness | 1.2mm             |



## HS090



- 特点**
- 1.一次性开合，全程缓冲中间不停顿
  - 2.双层加厚电镀，刚劲品质加倍耐用
- Advantage**
- 1.One time opening and closing, no pause in the entire buffer
  - 2.Thickened electroplating enhances durability
- 参数**
- 1.开门角度：90°
  - 2.铰杯厚度：11.5mm
  - 3.面板（K值）：3-7mm
  - 4.适用门板（厚）：14-24mm
- Parameter**
- 1.Opening degree: 90°
  - 2.Depth of hinge cup: 11.5mm
  - 3.Door K dimension: 3-7mm
  - 4.Range of door thickness:14-24mm

名称 Φ35 90°角度缓冲铰链固装

Name Φ35 90° FIXED ON HYDRAULIC BUFFERING HINGES

材质 冷轧钢 **Material** Cold rolled steel

厚度 1.2mm **Thickness** 1.2mm



## HS135



- 特点**
- 1.双层加厚电镀，刚劲品质加倍耐用
  - 2.带一键拆卸，方便安装调整
- Advantage**
- 1.Thickened electroplating enhances durability
  - 2.Clip on hinges, easily install and adjust
- 参数**
- 1.开门角度：135°
  - 2.铰杯厚度：11.5mm
  - 3.面板（K值）：3-7mm
  - 4.适用门板（厚）：14-24mm
- Parameter**
- 1.Opening degree: 135°
  - 2.Depth of hinge cup: 11.5mm
  - 3.Door K dimension: 3-7mm
  - 4.Range of door thickness:14-24mm

名称 Φ35 135°角度普通铰链卡式

Name Φ35 135° CLIP ON HINGES

材质 冷轧钢 **Material** Cold rolled steel

厚度 1.2mm **Thickness** 1.2mm



## HS190



- 特点**
- 1.一次性开合，全程缓冲中间不停顿
  - 2.双层加厚电镀，刚劲品质加倍耐用
  - 3.带一键拆卸，方便安装调整
- Advantage**
- 1.One time opening and closing, no pause during closing
  - 2.Thickened electroplating enhances durability
  - 3.Clip on hinges, easily install and adjust
- 参数**
- 1.开门角度：90°
  - 2.铰杯厚度：11.5mm
  - 3.面板（K值）：3-7mm
  - 4.适用门板（厚）：14-24mm
- Parameter**
- 1.Opening degree: 90°
  - 2.Depth of hinge cup: 11.5mm
  - 3.Door K dimension: 3-7mm
  - 4.Range of door thickness:14-24mm

名称 Φ35 90°角度缓冲铰链卡式

Name Φ35 90° CLIP ON HYDRAULIC BUFFERING HINGES

材质 冷轧钢 **Material** Cold rolled steel

厚度 1.2mm **Thickness** 1.2mm



## HS165



- 特点**
- 1.一次性开合，全程缓冲中间不停顿
  - 2.双层加厚电镀，刚劲品质加倍耐用
- Advantage**
- 1.One time opening and closing, no pause in the entire buffer
  - 2.Thickened electroplating enhances durability
- 参数**
- 1.开门角度：165°
  - 2.铰杯厚度：11.5mm
  - 3.面板（K值）：3-7mm
  - 4.适用门板（厚）：14-24mm
- Parameter**
- 1.Opening degree: 165°
  - 2.Depth of hinge cup: 11.5mm
  - 3.Door K dimension: 3-7mm
  - 4.Range of door thickness:14-24mm



中曲 C=10 大曲 C=14

名称 Φ35 165°角度缓冲铰链固装

Name Φ35 165° FIXED ON HYDRAULIC BUFFERING HINGES

材质 冷轧钢 **Material** Cold rolled steel

厚度 1.2mm **Thickness** 1.2mm



## HS265



- 特点**
- 1.一次性开合，全程缓冲中间不停顿
  - 2.双层加厚电镀，刚劲品质加倍耐用
  - 3.带一键拆卸，方便安装调整
- Advantage**
- 1.One time opening and closing, no pause during closing
  - 2.Thickened electroplating enhances durability
  - 3.Clip on hinges, easily install and adjust
- 参数**
- 1.开门角度：165°
  - 2.铰杯厚度：11.5mm
  - 3.面板（K值）：3-7mm
  - 4.适用门板（厚）：14-24mm
- Parameter**
- 1.Opening degree: 165°
  - 2.Depth of hinge cup: 11.5mm
  - 3.Door K dimension: 3-7mm
  - 4.Range of door thickness:14-24mm

名称 Φ35 165°角度缓冲铰链卡式  
Name Φ35 165° CLIP ON HYDRAULIC BUFFERING HINGES

材质 冷轧钢 Material Cold rolled steel  
厚度 1.2mm Thickness 1.2mm



## 300



- 特点**
- 1.开合轻柔静音
  - 2.双层加厚电镀，刚劲品质加倍耐用
- Advantage**
- 1.Soft and quiet
  - 2.Thickened electroplating enhances durability
- 参数**
- 1.开门角度：90°
  - 2.铰杯厚度：10.2mm
  - 3.面板（K值）：3-7mm
  - 4.适用门板（厚）：14-26mm
- Parameter**
- 1.Opening degree: 90°
  - 2.Depth of hinge cup: 10.2mm
  - 3.Door K dimension: 3-7mm
  - 4.Range of door thickness:14-26mm

名称 美式橱柜专用铰链 固装  
Name FIXED ON AMERICAN CABINET HINGE

材质 冷轧钢 Material Cold rolled steel  
厚度 1.2mm Thickness 1.2mm



## HS365



- 特点**
- 1.一次性开合，全程缓冲中间不停顿
  - 2.双层加厚电镀，刚劲品质加倍耐用
  - 3.带一键拆卸、三维调节，方便安装调整
- Advantage**
- 1.One time opening and closing, no pause during closing
  - 2.Thickened electroplating enhances durability
  - 3.Clip on hinges, 3D adjustment, easily install and adjust
- 参数**
- 1.开门角度：165°
  - 2.铰杯厚度：11.5mm
  - 3.面板（K值）：3-7mm
  - 4.适用门板（厚）：14-24mm
- Parameter**
- 1.Opening degree: 165°
  - 2.Depth of hinge cup: 11.5mm
  - 3.Door K dimension: 3-7mm
  - 4.Range of door thickness:14-24mm

名称 Φ35 165°角度缓冲铰链卡式三维  
Name Φ35 165° CLIP ON 3D ADJUSTABLE HYDRAULIC BUFFERING HINGES

材质 冷轧钢 Material Cold rolled steel  
厚度 1.2mm Thickness 1.2mm

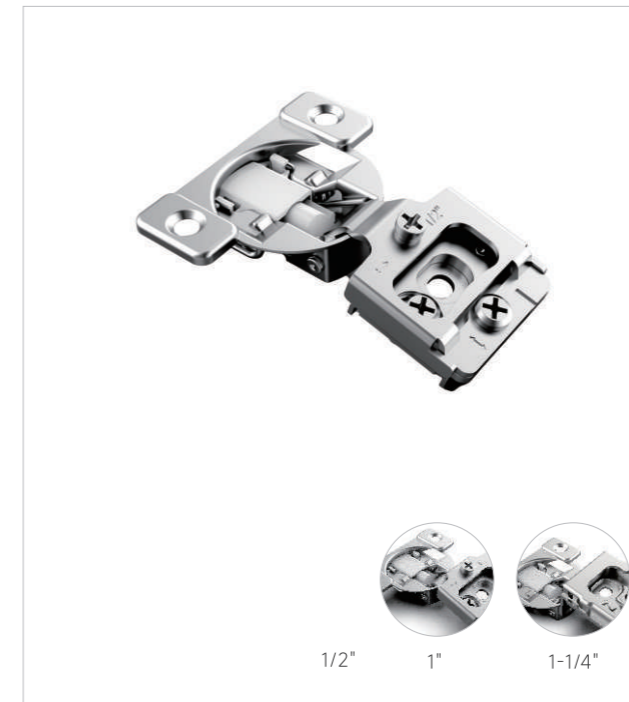

## 310



- 特点**
- 1.一次性开合，全程缓冲中间不停顿
  - 2.双层加厚电镀，刚劲品质加倍耐用
  - 3.三维调节，拆装便捷
- Advantage**
- 1.One time opening and closing, no pause in the entire buffer
  - 2.Thickened electroplating enhances durability
  - 3.3D adjustment, easily install and adjust
- 参数**
- 1.开门角度：90°
  - 2.铰杯厚度：10.2mm
  - 3.面板（K值）：3-7mm
  - 4.适用门板（厚）：14-26mm
- Parameter**
- 1.Opening degree: 90°
  - 2.Depth of hinge cup: 10.2mm
  - 3.Door K dimension: 3-7mm
  - 4.Range of door thickness:14-26mm

名称 美式橱柜专用缓冲铰链 快装 三维调整  
Name CLIP ON 3D ADJUSTABLE AMERICAN CABINET HYDRAULIC BUFFERING HINGE

材质 冷轧钢 Material Cold rolled steel  
厚度 1.2mm Thickness 1.2mm





### 311



- 特点**
- 1.一次性开合，全程缓冲中间不停顿
  - 2.双层加厚电镀，刚劲品质加倍耐用
  - 3.拆装便捷
- Advantage**
- 1.One time opening and closing, no pause in the entire buffer
  - 2.Thickened electroplating enhances durability
  - 3.Convenient splited and installed
- 参数**
- 1.开门角度：90°
  - 2.铰杯厚度：10.2mm
  - 3.面板（K值）：3-7mm
  - 4.适用门板（厚）：14-26mm
- Parameter**
- 1.Opening degree: 90°
  - 2.Depth of hinge cup: 10.2mm
  - 3.Door K dimension: 3-7mm
  - 4.Range of door thickness:14-26mm

**名称** 美式橱柜专用缓冲铰链 快装  
**Name** CLIP ON AMERICAN CABINET HYDRAULIC BUFFERING HINGE

**材质** 冷轧钢 **Material** Cold rolled steel  
**厚度** 1.2mm **Thickness** 1.2mm



### 313



- 特点**
- 1.一次性开合，全程缓冲中间不停顿
  - 2.双层加厚电镀，刚劲品质加倍耐用
  - 3.三维调节，双孔加固
- Advantage**
- 1.One time opening and closing, no pause during closing
  - 2.Thickened electroplating enhances durability
  - 3.3D adjustment, two assemble holes to make more stable
- 参数**
- 1.开门角度：90°
  - 2.铰杯厚度：10.2mm
  - 3.面板（K值）：3-7mm
  - 4.适用门板（厚）：14-26mm
- Parameter**
- 1.Opening degree: 90°
  - 2.Depth of hinge cup: 10.2mm
  - 3.Door K dimension: 3-7mm
  - 4.Range of door thickness:14-26mm

**名称** 美式橱柜专用缓冲铰链 固装 三维调整  
**Name** FIXED ON 3D ADJUSTABLE AMERICAN CABINET HYDRAULIC BUFFERING HINGE

**材质** 冷轧钢 **Material** Cold rolled steel  
**厚度** 1.2mm **Thickness** 1.2mm



### 312



- 特点**
- 1.一次性开合，全程缓冲中间不停顿
  - 2.双层加厚电镀，刚劲品质加倍耐用
  - 3.拆装便捷，双孔加固
- Advantage**
- 1.One time opening and closing, no pause in the entire buffer
  - 2.Thickened electroplating enhances durability
  - 3.Two assemble holes to make more stable convenient splited and installed
- 参数**
- 1.开门角度：90°
  - 2.铰杯厚度：10.2mm
  - 3.面板（K值）：3-7mm
  - 4.适用门板（厚）：14-26mm
- Parameter**
- 1.Opening degree: 90°
  - 2.Depth of hinge cup: 10.2mm
  - 3.Door K dimension: 3-7mm
  - 4.Range of door thickness:14-26mm

**名称** 美式橱柜专用缓冲铰链 快装  
**Name** CLIP ON AMERICAN CABINET HYDRAULIC BUFFERING HINGE

**材质** 冷轧钢 **Material** Cold rolled steel  
**厚度** 1.2mm **Thickness** 1.2mm

# FURNITURE LEG SERIES

家具脚系列



桌子脚系列  
TABLE LEG SERIES



沙发脚系列  
SOFA LEG SERIES



家具脚系列  
FURNITURE LEG SERIES



名称: 桌子架 铁板  
 Name: TABLE FRAME LEG (IRON PLATE)  
 材质: 冷轧钢  
 Material: Cold rolled steel

特点: 1. 承重可达200Kgs  
 2. 可调节20mm  
 3. 尺寸可定制  
 4. 盐雾测试达120小时

Advantage: 1. Capacity up to 200KGS  
 2. Adjustment length up to 20mm  
 3. Custom-size  
 4. Salty spray test can reach to 120 hours



TG3011P



TG3031P

名称: 桌子架 铁管  
 Name: TABLE FRAME LEG (IRON TUBE)  
 材质: 冷轧钢  
 Material: Cold rolled steel

特点: 1. 承重可达200Kgs  
 2. 可调节20mm  
 3. 尺寸可定制  
 4. 盐雾测试达120小时

Advantage: 1. Capacity up to 200KGS  
 2. Adjustment length up to 20mm  
 3. Custom-size  
 4. Salty spray test can reach to 120 hours



TG3011F



TG3022F



TG3021P



TG3022P



TG3021F



TG3031F

名称: 桌子脚圆管  
Name: TABLE LEG ROUND TUBE

载重: 100kgs  
Load Capacity: 100kgs

尺寸: 100-1100mm  
Length: 100-1100mm

颜色: 拉比镍/光铬/银色/黑色/白色  
Color: Satin Nickel/Chrome/  
Silver/Black/White



**TG601**

Φ60mm圆台脚(梅花底座)



**TG602**

Φ60mm圆台脚(鱼尾叉底座)



**TG603**

Φ60mm圆台脚(铝合金底座)



**TG604**

Φ60mm圆台脚(鱼尾叉B底座)



**TG605**

35x60mm 锥形台脚



**TG606**

Φ60mm 锥形台脚



**TG607**

Φ60mm圆台脚



**TG608**

Φ60mm锥形台脚



**TG612**

Φ50mm 折叠台脚



**TG609**

Φ60mm 伸缩脚



**TG613**

Φ60mm伸缩折叠台脚



**TG610**

Φ60mm方管



**TG614**

10mm三叉台脚



名称: 桌子脚线型  
Name: TABLE LEG LINE TYPE

载重: 100kgs  
Load Capacity: 100kgs

尺寸: 100-1100mm  
Length: 100-1100mm

颜色: 拉比镍/光铬/银色/黑色/白色  
Color: Satin Nickel/Chrome/  
Silver/Black/White



**TG615**

Φ10mm四叉台脚



名称: 桌子脚线型  
Name: TABLE LEG LINE TYPE

载重: 100kgs  
Load Capacity: 100kgs

尺寸: 100-1100mm  
Length: 100-1100mm

颜色: 拉比镍/光铬/银色/黑色/白色  
Color: Satin Nickel/Chrome/  
Silver/Black/White



**TG616**

Φ12mm三叉台脚



名称: 桌子脚线型  
Name: TABLE LEG LINE TYPE

载重: 500kgs  
Load Capacity: 500kgs

尺寸: 100-1100mm  
Length: 100-1100mm

颜色: 拉比镍/光铬/银色/黑色/白色  
Color: Satin Nickel/Chrome/  
Silver/Black/White



**TG617**

Φ10mm四叉台脚



名称: 桌子脚线型  
Name: TABLE LEG LINE TYPE

载重: 500kgs  
Load Capacity: 500kgs

尺寸: 100-1100mm  
Length: 100-1100mm

颜色: 拉比镍/光铬/银色/黑色/白色  
Color: Satin Nickel/Chrome/  
Silver/Black/White



**TG618**

Φ12mm三叉台脚



名称: 桌子脚线型  
Name: TABLE LEG LINE TYPE

载重: 500kgs  
Load Capacity: 500kgs

尺寸: 100-1100mm  
Length: 100-1100mm

颜色: 拉比镍/光铬/银色/黑色/白色  
Color: Satin Nickel/Chrome/  
Silver/Black/White



**TG619**

Φ12mm伸缩折叠台脚



名称: 桌子脚线型  
Name: TABLE LEG LINE TYPE

载重: 500kgs  
Load Capacity: 500kgs

尺寸: 100-1100mm  
Length: 100-1100mm

颜色: 拉比镍/光铬/银色/黑色/白色  
Color: Satin Nickel/Chrome/  
Silver/Black/White



**TG501**

沙发脚(胶塞可调,底座不可调)

尺寸: 100-1100mm  
 载重: 100kgs  
 颜色: 拉比镍/光铬/银色/黑色/白色  
 主要材料: 铁+塑料+尼龙



Length: 100-1100mm  
 Load Capacity: 100kgs  
 Color: Satin Nickel/Chrome/Silver/Black/White  
 Main Material: Iron+Plastic+PA6

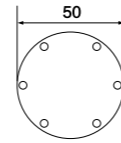

名称:  $\Phi$ 50mm圆管沙发脚  
 Name:  $\Phi$ 50MM ROUND TUBE SOFA LEG



**TG505**

60mm 圆台脚(铝合金底座)

尺寸: 100-1100mm  
 载重: 100kgs  
 颜色: 拉比镍/光铬/银色/黑色/白色  
 主要材料: 铁+塑料+尼龙



Length: 100-1100mm  
 Load Capacity: 100kgs  
 Color: Satin Nickel/Chrome/Silver/Black/White  
 Main Material: Iron+Plastic+PA6

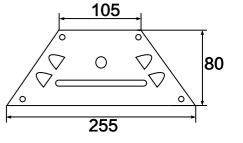

名称:  $\Phi$ 60mm圆管沙发脚  
 Name:  $\Phi$ 60MM ROUND TUBE SOFA LEG



**TG502**

沙发脚(塑料底座可调)

尺寸: 100-1100mm  
 载重: 100kgs  
 颜色: 拉比镍/光铬/银色/黑色/白色  
 主要材料: 铁+塑料+尼龙



Length: 100-1100mm  
 Load Capacity: 100kgs  
 Color: Satin Nickel/Chrome/Silver/Black/White  
 Main Material: Iron+Plastic+PA6

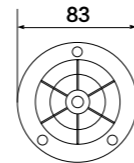

名称:  $\Phi$ 50mm圆管沙发脚  
 Name:  $\Phi$ 50MM ROUND TUBE SOFA LEG



**TG506**

沙发脚

尺寸: 100-1100mm  
 载重: 100kgs  
 颜色: 拉比镍/光铬/银色/黑色/白色  
 主要材料: 铁+塑料+尼龙



Length: 100-1100mm  
 Load Capacity: 100kgs  
 Color: Satin Nickel/Chrome/Silver/Black/White  
 Main Material: Iron+Plastic+PA6

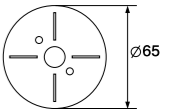

名称:  $\Phi$ 50mm圆管沙发脚  
 Name:  $\Phi$ 50MM ROUND TUBE SOFA LEG



**TG503**

$\Phi$ 45MM沙发脚

尺寸: 100-1100mm  
 载重: 100kgs  
 颜色: 拉比镍/光铬/银色/黑色/白色  
 主要材料: 铁+塑料+尼龙



Length: 100-1100mm  
 Load Capacity: 100kgs  
 Color: Satin Nickel/Chrome/Silver/Black/White  
 Main Material: Iron+Plastic+PA6

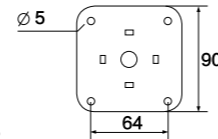

名称:  $\Phi$ 45mm圆管沙发脚  
 Name:  $\Phi$ 45MM ROUND TUBE SOFA LEG



**TG3001**

沙发脚

尺寸: 100-700mm  
 载重: 80kgs  
 颜色: 拉比镍/光铬/银色/黑色/白色  
 主要材料: 铁+塑料+尼龙



Length: 100-700mm  
 Load Capacity: 80kgs  
 Color: Satin Nickel/Chrome/Silver/Black/White  
 Main Material: Iron+Plastic+PA6

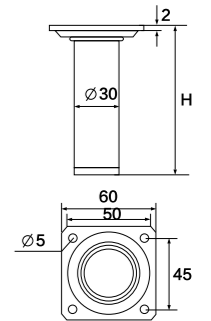

名称:  $\Phi$ 30mm圆管沙发脚  
 Name:  $\Phi$ 30MM ROUND TUBE SOFA LEG



**TG504**

沙发脚

尺寸: 100-1100mm  
 载重: 100kgs  
 颜色: 拉比镍/光铬/银色/黑色/白色  
 主要材料: 铁+塑料+尼龙



Length: 100-1100mm  
 Load Capacity: 100kgs  
 Color: Satin Nickel/Chrome/Silver/Black/White  
 Main Material: Iron+Plastic+PA6

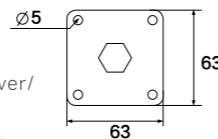

名称:  $\Phi$ 50mm圆管沙发脚  
 Name:  $\Phi$ 50MM ROUND TUBE SOFA LEG



**TG3002**

沙发脚

尺寸: 100-900mm  
 载重: 80kgs  
 颜色: 拉比镍/光铬/银色/黑色/白色  
 主要材料: 铁+塑料+尼龙



Length: 100-900mm  
 Load Capacity: 80kgs  
 Color: Satin Nickel/Chrome/Silver/Black/White  
 Main Material: Iron+Plastic+PA6

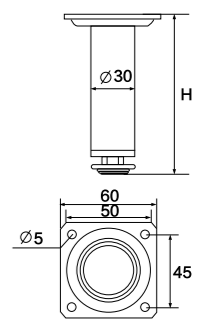

名称:  $\Phi$ 30mm圆管沙发脚  
 Name:  $\Phi$ 30MM ROUND TUBE SOFA LEG



**TG2501**

沙发脚(铆接款)



尺寸: 100-1100mm

载重: 100kgs

颜色: 拉比镍/光铬/银色/黑色/白色

Length: 100-1100mm

Load Capacity: 100kgs

Color: Satin Nickel/Chrome/  
Silver/Black/White

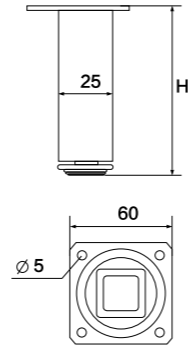

名称: Φ25mm方管沙发脚  
Name: Φ25MM SQUARE TUBE SOFA LEG



**TG2502**

沙发脚



尺寸: 100-1100mm

载重: 100kgs

颜色: 拉比镍/光铬/银色/黑色/白色

Length: 100-1100mm

Load Capacity: 100kgs

Color: Satin Nickel/Chrome/  
Silver/Black/White

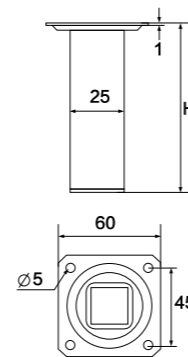

名称: Φ25mm方管沙发脚  
Name: Φ25MM SQUARE TUBE SOFA LEG



**TG2503**

沙发脚



尺寸: 100-1100mm

载重: 100kgs

颜色: 拉比镍/光铬/银色/黑色/白色

Length: 100-1100mm

Load Capacity: 100kgs

Color: Satin Nickel/Chrome/  
Silver/Black/White

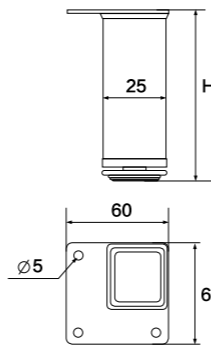

名称: Φ25mm方管沙发脚  
Name: Φ25MM SQUARE TUBE SOFA LEG



**TG01**

Φ60MM圆台脚(铝合金底座)



尺寸: 100-1100mm

载重: 50kgs

颜色: 拉比镍/光铬/银色/黑色/白色

Length: 100-1100mm

Load Capacity: 50kgs

Color: Satin Nickel/Chrome/  
Silver/Black/White

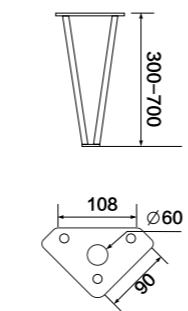

名称: 冲压沙发脚  
Name: STAMPING SOFA LEG



**TG02**

Φ50MMU型脚



尺寸: 100-1100mm

载重: 100kgs

颜色: 拉比镍/光铬/银色/黑色/白色

Length: 100-1100mm

Load Capacity: 100kgs

Color: Satin Nickel/Chrome/  
Silver/Black/White

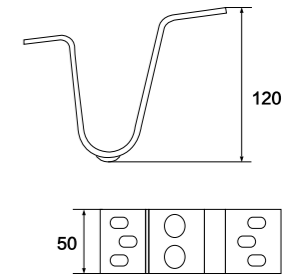

名称: 冲压沙发脚  
Name: STAMPING SOFA LEG



**P201**

塑料橱柜脚



尺寸: A 100mm /120mm /150mm  
B 130mm/150mm /180mm

颜色: 拉比镍/光铬/银色/黑色/白色

主要材料: ABS/PP

Length: A 100mm /120mm /150mm  
B 130mm/150mm /180mm

Color: Satin Nickel/Chrome/  
Silver/Black/White

Main Material: ABS/PP

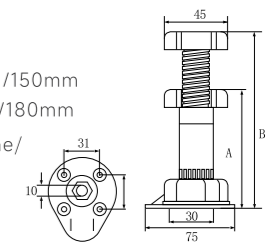

名称: 橱柜脚  
Name: CABINET LEG



**P202**

塑料橱柜脚



尺寸: A 100mm /120mm /150mm  
b 130mm/150mm /180mm

颜色: 拉比镍/光铬/银色/黑色/白色

主要材料: ABS/PP

Length: A 100mm /120mm /150mm  
b 130mm/150mm /180mm

Color: Satin Nickel/Chrome/  
Silver/Black/White

Main Material: ABS/PP

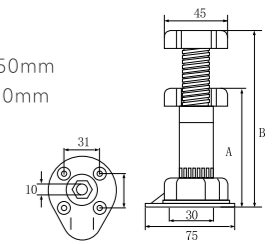

名称: 橱柜脚  
Name: CABINET LEG



**P203**

木板卡

主要材料: PP  
Main Material: PP



**P204**

铝塑卡

主要材料: PP  
Main Material: PP



**P205**

铝塑卡

主要材料: PP  
Main Material: PP



# FURNITURE COMPONENT SERIES

家具组件系列



家具组件系列  
FURNITURE COMPONENT SERIES





### AG1512



产品规格: Ø15x11.8mm

表面处理: 镀镍/镀锌

主要材料: 锌合金

Drilling Distance: Ø15x11.8mm

Finish: Zinc-Plated/Nickel-Plated

Main Material: Zinc Alloy

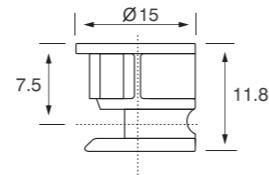

名称: Ø15mm锌合金偏心轮  
Name: Ø15MM CAMS



### AG1212



产品规格: Ø12x12mm

表面处理: 枪黑/镀镍/镀锌

主要材料: 锌合金

Drilling Distance: Ø12x12mm

Finish: Iron Black/Zinc-Plated/Nickel-Plated

Main Material: Zinc Alloy

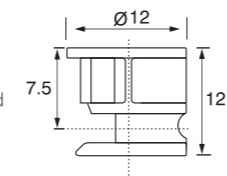

名称: Ø12mm锌合金偏心轮  
Name: Ø12MM CAMS



### AG1011



产品规格: Ø10x11mm

表面处理: 镀镍/镀锌

主要材料: 锌合金

Drilling Distance: Ø10x11mm

Finish: Zinc-Plated/Nickel-Plated

Main Material: Zinc Alloy

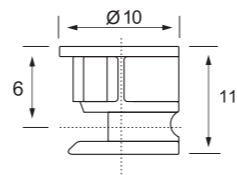

名称: Ø10mm锌合金偏心轮  
Name: Ø10MM CAMS



### AG1501



产品规格: Ø15x12mm

表面处理: 镀镍/镀锌

主要材料: Q195

Drilling Distance: Ø15x12mm

Finish: Zinc-Plated/Nickel-Plated

Main Material: Q195

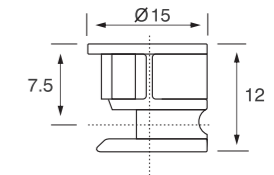

名称: Ø15mm铁合金偏心轮  
Name: Ø15MM CAMS



### AG1201



产品规格: Ø12x12mm

表面处理: 枪黑/镀镍/镀锌

主要材料: Q195

Drilling Distance: Ø12x12mm

Finish: Iron Black/Zinc-Plated/Nickel-Plated

Main Material: Q195

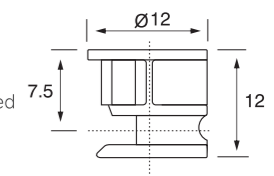

名称: Ø12mm铁合金偏心轮  
Name: Ø12MM CAMS



### PG12



产品规格: Ø13.2x4.3mm

表面处理: 枪黑/镍

主要材料: 铁+POM

Drilling Distance: Ø13.2x4.3mm

Finish: Iron Black/Nickel

Main Material: Iron+POM

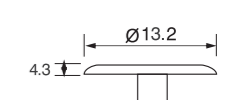

名称: Ø12mm偏心轮装饰盖  
Name: Ø12MM ECCENTRIC DECORATIVE COVER



### CG11/CG10



表面处理: 黑色+锌

颜色: 透明

主要材料: 尼龙

Finish: Black+Zinc-Plated

Color: Transparent

Main Material: PA6

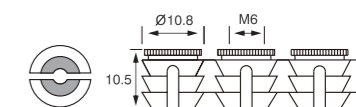

名称: 快装预埋件  
Name: NUTS





### BG32A



产品规格:  $\varnothing 7.3 \times 32$ , A=25mm

表面处理: 彩锌+黑色

主要材料: 6A铁+塑料+尼龙

Drilling Distance:  $\varnothing 7.3 \times 32$ , A=25mm

Finish: Zinc+Black

Main Material: 6A Iron+Plastic+PA6

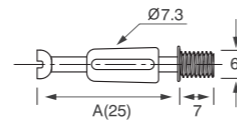

名称: 组合式快装螺杆  
Name: DOWELS



### BG35A



产品规格:  $\varnothing 7.3 \times 35$ , A=28mm

表面处理: 彩锌+灰色

主要材料: 6A铁+塑料+尼龙

Drilling Distance:  $\varnothing 7.3 \times 35$ , A=28mm

Finish: Zinc+Gray

Main Material: 6A Iron+Plastic+PA6

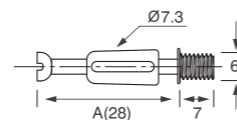

名称: 组合式快装螺杆  
Name: DOWELS



### BG40A



产品规格:  $\varnothing 7.3 \times 40$ , A=33mm

表面处理: 彩锌+灰色

主要材料: 6A铁+塑料+尼龙

Drilling Distance:  $\varnothing 7.3 \times 40$ , A=33mm

Finish: Zinc+Gray

Main Material: 6A Iron+Plastic+PA6

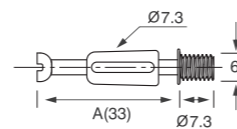

名称: 组合式快装螺杆  
Name: DOWELS



### BG41A



产品规格:  $\varnothing 7.3 \times 41$ , A=34mm

表面处理: 彩锌+灰色

主要材料: 6A铁+塑料+尼龙

Drilling Distance:  $\varnothing 7.3 \times 41$ , A=34mm

Finish: Zinc+Gray

Main Material: 6A Iron+Plastic+PA6

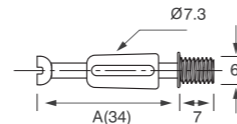

名称: 组合式快装螺杆  
Name: DOWELS

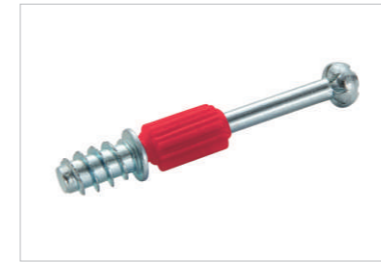

### BG45



产品规格:  $\varnothing 7.3 \times 45$ , A=34mm

表面处理: 锌+红色

主要材料: 6A铁+塑料

Drilling Distance:  $\varnothing 7.3 \times 45$ , A=34mm

Finish: Zinc+Red

Main Material: 6A Iron+Plastic

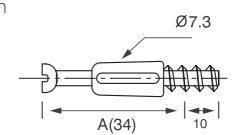

名称: 自攻螺杆  
Name: DOWELS



### BG44A



产品规格:  $\varnothing 8 \times 44$ , A=34mm

表面处理: 锌+黑色

主要材料: 6A铁+塑料

Drilling Distance:  $\varnothing 8 \times 44$ , A=34mm

Finish: Zinc+Black

Main Material: 6A Iron+Plastic

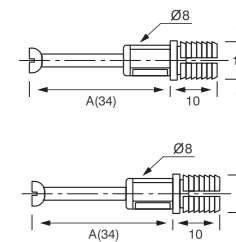

名称: 一体式快装螺杆  
Name: BOARD CONNECTORS



### BG34A



产品规格:  $\varnothing 8 \times 34$ , A=24mm

表面处理: 锌+黑色

主要材料: 6A铁+塑料

Drilling Distance:  $\varnothing 8 \times 34$ , A=24mm

Finish: Zinc+Black

Main Material: 6A Iron+Plastic

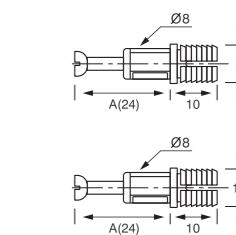

名称: 一体式快装螺杆  
Name: BOARD CONNECTORS



GA20



产品规格:  $\varnothing 20 \times 12.5 \text{mm}$     Drilling Distance:  $\varnothing 20 \times 12.5 \text{mm}$   
 表面处理: 白色/咖啡色+镀镍    Finish: White/Brown+Nickel-Plated  
 主要材料: 锌合金+塑料    Main Material: Zinc Alloy+Plastic

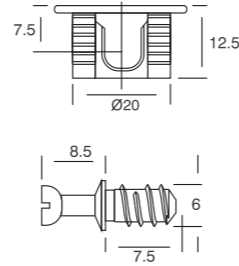

名称:  $\varnothing 20 \text{MM}$ 层板托偏心层板连接件  
 Name:  $\varnothing 20 \text{MM}$  BOARD CONNECTORS



P301



产品规格:  $\varnothing 5 \times 18 \text{mm}$     Drilling Distance:  $\varnothing 5 \times 18 \text{mm}$   
 颜色: 透明/咖啡/白色/黑色    Color: Transparent / Brown/White / Black  
 主要材料: K树脂PS    Main Material: K resin PS

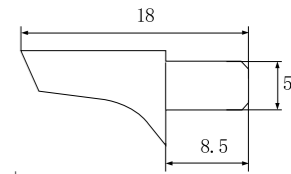

名称: 5mm层板托  
 Name: 5MM BOARD SUPPORT



EG12T



产品规格:  $\varnothing 12 \times 13.5 \text{mm}$     Drilling Distance:  $\varnothing 12 \times 13.5 \text{mm}$   
 表面处理: 枪黑    Finish: Iron Black  
 主要材料: 锌合金+ABS    Main Material: Zinc Alloy+ABS

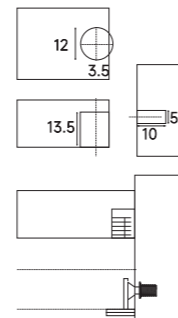

名称:  $\varnothing 12 \text{MM}$ 三合一嵌入层板连接件 (矩型)  
 Name:  $\varnothing 12 \text{MM}$  BOARD CONNECTORS



P303



产品规格:  $\varnothing 5 \times 19 \text{mm}$     Drilling Distance:  $\varnothing 5 \times 19 \text{mm}$   
 颜色: 透明/咖啡/白色/黑色    Color: Transparent / Brown/White / Black  
 主要材料: K树脂PS    Main Material: K resin PS

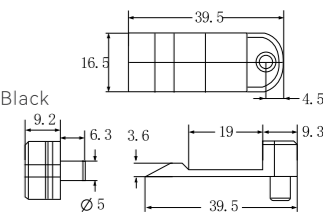

名称: 19mm板托  
 Name: 19MM BOARD SUPPORT



EG12S



产品规格:  $\varnothing 12 \times 13.5 \text{mm}$     Drilling Distance:  $\varnothing 12 \times 13.5 \text{mm}$   
 表面处理: 枪黑    Finish: Iron Black  
 主要材料: 锌合金+ABS    Main Material: Zinc Alloy+ABS

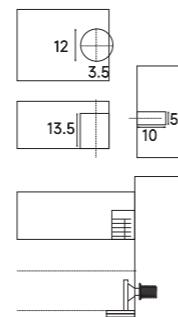

名称:  $\varnothing 12 \text{MM}$ 三合一嵌入层板连接件 (方型)  
 Name:  $\varnothing 12 \text{MM}$  BOARD CONNECTORS



P304



产品规格:  $\varnothing 5 \times 16.5 \text{mm}$     Drilling Distance:  $\varnothing 5 \times 16.5 \text{mm}$   
 颜色: 透明/咖啡/白色/黑色    Color: Transparent / Brown/White / Black  
 主要材料: K树脂PS    Main Material: K resin PS

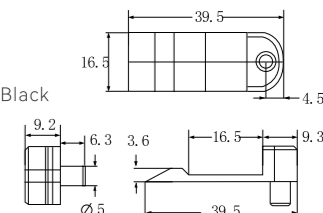

名称: 16mm板托  
 Name: 16MM BOARD SUPPORT



EG12C



产品规格:  $\varnothing 12 \times 13.5 \text{mm}$     Drilling Distance:  $\varnothing 12 \times 13.5 \text{mm}$   
 表面处理: 枪黑    Finish: Iron Black  
 主要材料: 锌合金+ABS    Main Material: Zinc Alloy+ABS

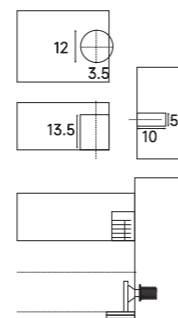

名称:  $\varnothing 12 \text{MM}$ 三合一嵌入层板连接件 (半圆)  
 Name:  $\varnothing 12 \text{MM}$  BOARD CONNECTORS

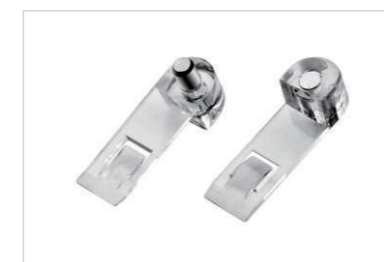

P305



产品规格:  $\varnothing 5 \times 13 \text{mm}$     Drilling Distance:  $\varnothing 5 \times 13 \text{mm}$   
 颜色: 透明/咖啡/白色/黑色    Color: Transparent / Brown/White / Black  
 主要材料: K树脂PS    Main Material: K resin PS

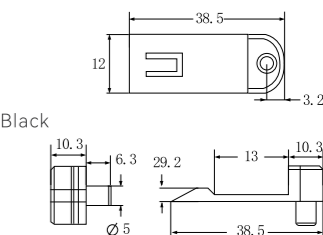

名称: 19mm反弹板托  
 Name: 19MM BOARD SUPPORT



G01

直径: 16-60mm  
颜色: 光铬  
主要材料: 铁  
厚度: 0.5-1.2mm



Diameter: 16-60mm  
Color: Chrome  
Main Material: Iron  
Thickness: 0.5-1.2mm

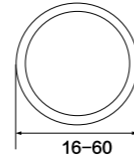

名称: 铁圆衣通管  
Name: ROUND WARDROBE TUBE



G02

直径: 15-30mm  
颜色: 光铬  
主要材料: 铁  
厚度: 0.5-1.2mm



Diameter: 15-30mm  
Color: Chrome  
Main Material: Iron  
Thickness: 0.5-1.2mm

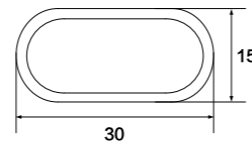

名称: 铁椭圆衣通管  
Name: OVAL WARDROBE TUBE



D01

产品规格: 12x45mm  
颜色: 电镀镍  
主要材料: 锌合金



Drilling Distance: 12x45mm  
Color: Nickel  
Main Material: Zinc Alloy

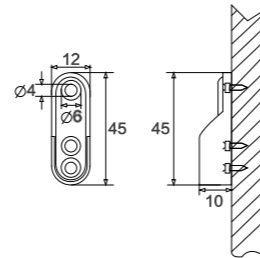

名称: 铁椭圆衣通托  
Name: IRON WARDROBE TUBE SUPPORT



D03

产品规格: 19x44mm  
颜色: 电镀镍  
主要材料: 锌合金



Drilling Distance: 19x44mm  
Color: Nickel  
Main Material: Zinc Alloy

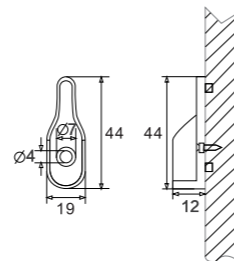

名称: 铁椭圆衣通托  
Name: IRON WARDROBE TUBE SUPPORT



D04

产品规格: 18x42  
颜色: 电镀镍  
主要材料: 锌合金



Drilling Distance: 18x42  
Color: Nickel  
Main Material: Zinc Alloy

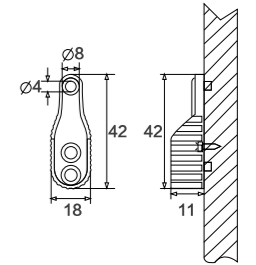

名称: 铁椭圆衣通托  
Name: IRON WARDROBE TUBE SUPPORT



D05

产品规格: 18x44  
颜色: 电镀镍  
主要材料: 锌合金



Drilling Distance: 18x44  
Color: Nickel  
Main Material: Zinc Alloy

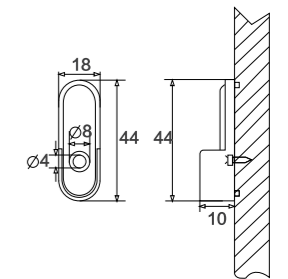

名称: 铁椭圆衣通托  
Name: IRON WARDROBE TUBE SUPPORT



D07

产品规格: 31x71  
颜色: 电镀镍  
主要材料: 锌合金



Drilling Distance: 31x71  
Color: Nickel  
Main Material: Zinc Alloy

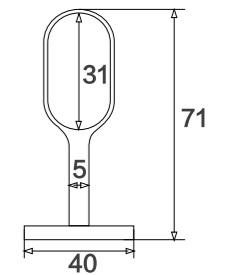

名称: 铁椭圆衣通托  
Name: IRON WARDROBE TUBE SUPPORT



FT01

可调节范围: 1-7毫米  
闭合总长: 80-86毫米  
主要材料: 塑料  
适用范围: 用于2.5米高内柜门  
颜色: 灰白色 黑色



Adjustable range: 1-7mm  
Total closing length: 80 - 86mm  
Main material: Plastic  
Scope of application: For 2.5m high inner cabinet door  
Color: Gray-white/Black

名称: 柜门反弹器  
Name: CABINET BOUNCER