

## MODEL 340-FL-03-U05

### 3.5 x 3.5mm Metal Sealed SMD Flat Top Type

#### Typical Optical-Electrical Characteristics

( $I_F=350\text{mA}$ ,  $T_a=25^\circ\text{C}$ )

Item	Symbol	Unit	Min	Typ	Max
Peak Wavelength(*)	$\lambda_p$	nm	335	340	345
Radiant Flux(**)	$P_o$	mW	70	90	-
Full Width at Half Maximum	$\Delta\lambda$	nm	-	10	-
Forward voltage	$V_F$	V	3.8	-	5.5
Viewing Half Angle	$2\theta_{1/2}$	deg.	-	120	-

(\*)Peak Wavelength Measurement tolerance is  $\pm 3\text{nm}$ .

(\*\*)Radiant Flux Measurement tolerance is  $\pm 10\%$ .

Specification and dimension are subject to change for improvement without notice.

#### Mechanical Specifications and Exterior photo

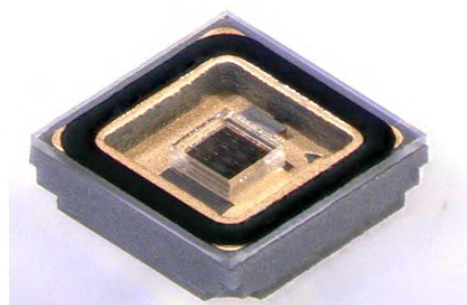
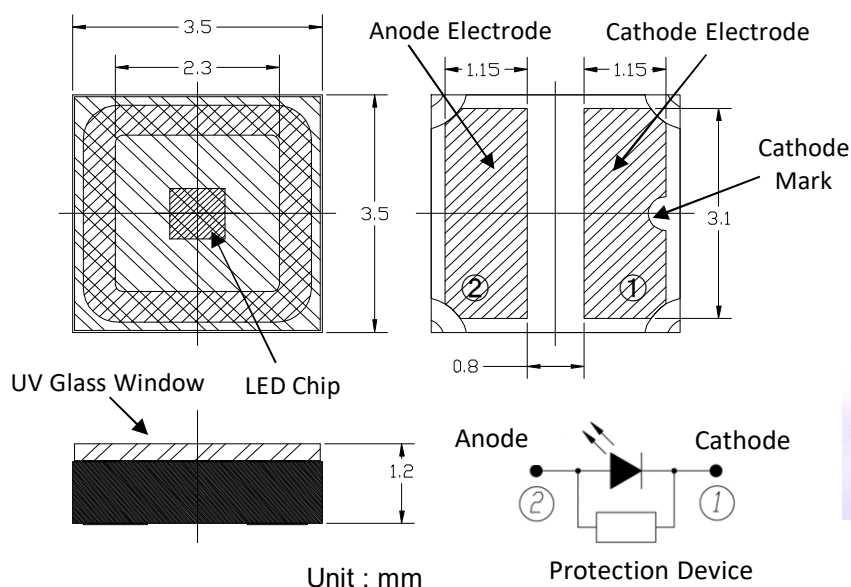

## MODEL 340-FL-03-U05

### 3.5 x 3.5mm Metal Sealed SMD Flat Top Type

#### Absolute Maximum Ratings

Item	Symbol	Unit	Value
Forward Current	$I_F$	mA	600
Reverse Voltage	$V_R$	V	5
Junction Temperature	$T_J$	°C	90
Operating Temperature	$T_{OPR}$	°C	-30 ~ +85
Storage Temperature	$T_{STR}$	°C	-40 ~ +85 (No condensation)

#### Derating Curve

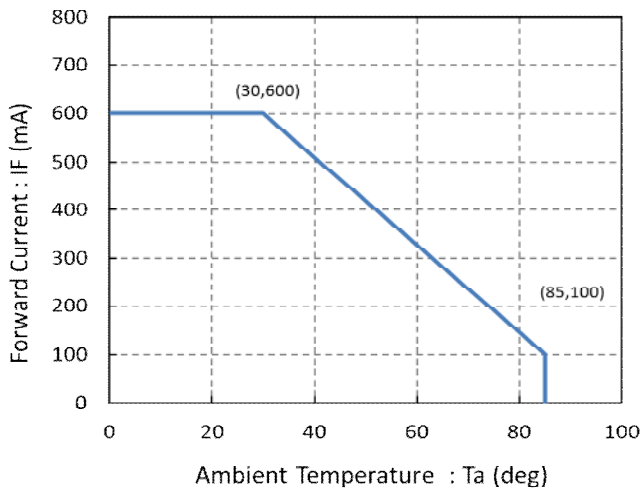

#### Recommended solder pad

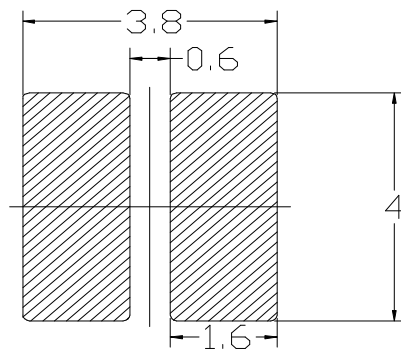

Unit : mm

#### Reflow soldering profile

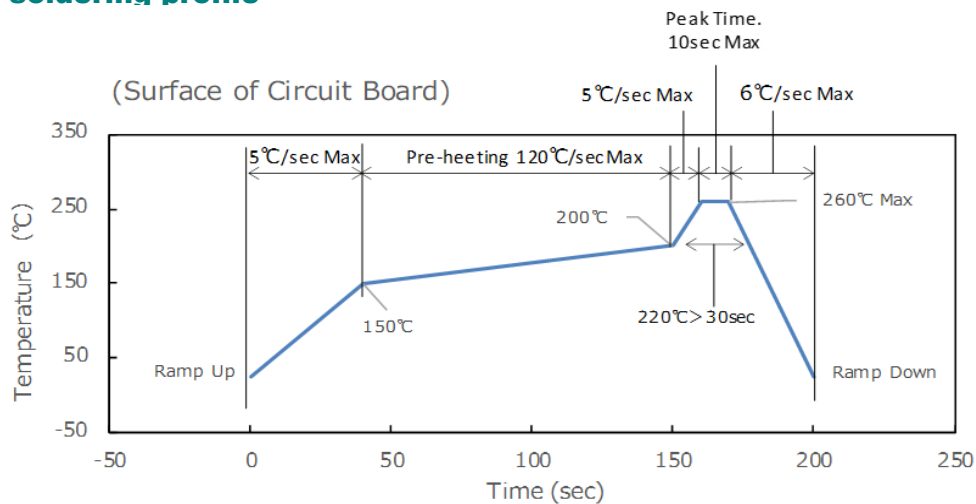

# MODEL 340-FL-03-U05

## 3.5 x 3.5mm Metal Sealed SMD Flat Top Type

### Forward Voltage vs Forward Current

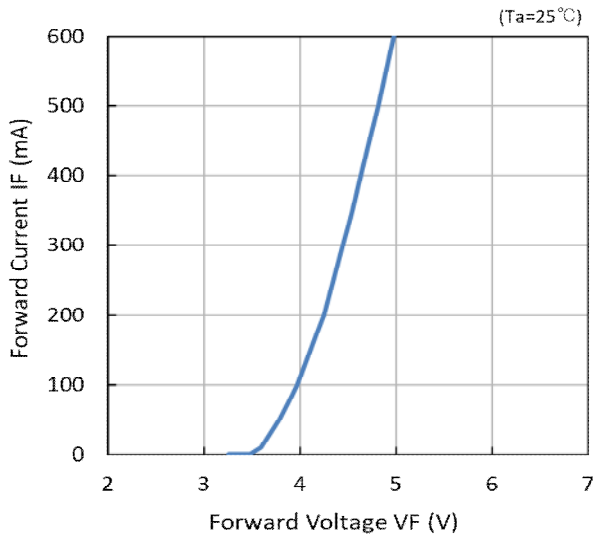

### Forward Current vs Radiant Flux

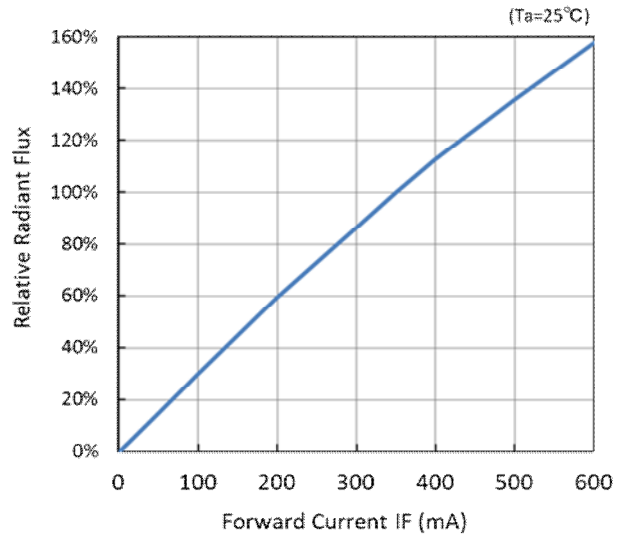

### Spectrum

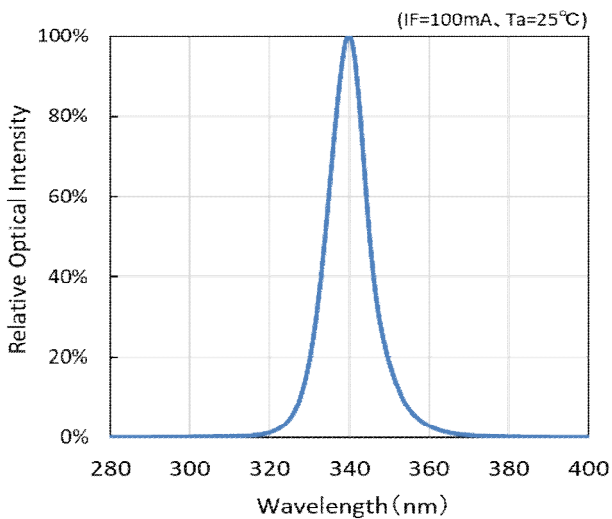

- These data as on the page 3 were determined with Al-substrate on a heat sink and fan.

## MODEL 340-FL-03-U05

### 3.5 x 3.5mm Metal Sealed SMD Flat Top Type

#### Radiation Pattern

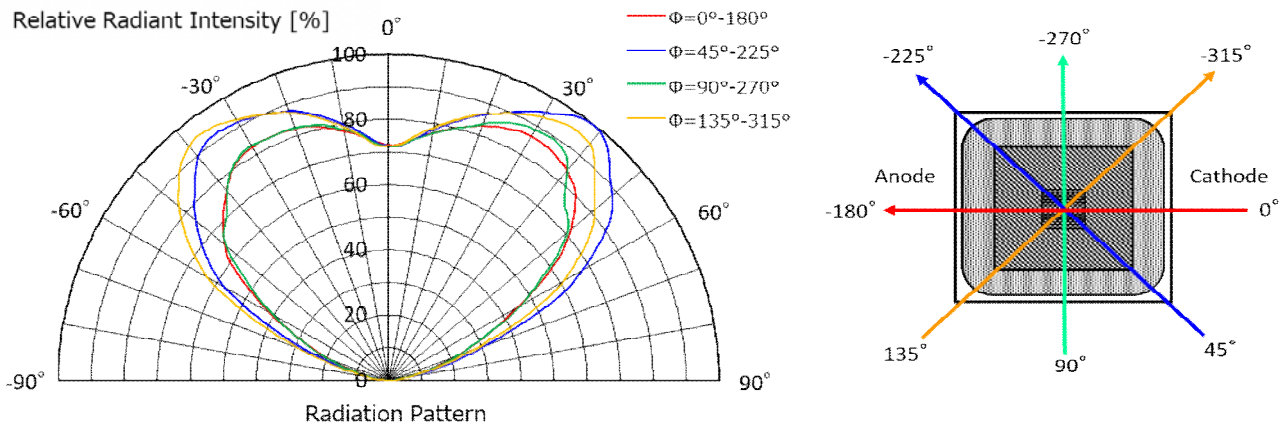

#### Handling Static Electricity

This product is sensitive to static electricity and surge voltages, which may damage the device and reduce reliability. When handling the product, please refer to the example below and take sufficient measures against static electricity.

- Charge removal using wrist straps, conductive clothing, conductive shoes, conductive flooring, etc.
- Eliminating electric charges by installing equipment, jigs, etc. in the work area.
- Installation of workbenches, storage shelves, etc. using conductive materials.

<b>⚠ WARNING</b>	
	<ul style="list-style-type: none"> <li>• LEDs emit very strong UV radiation.</li> <li>• Do not look at the LED light with the naked eye or irradiate the skin.</li> <li>• UV radiation can harm your eyes and skin.</li> <li>• To prevent UV radiation exposure, wear protective eyewear and protective equipment.</li> <li>• If LEDs are embedded in devices, please indicate warning labels against the UV light LED used.</li> <li>• Keep out of reach of children.</li> </ul>