

MODEL 325-FL-03-G01

3.5 x 3.5mm Metal Sealed SMD Hemispherical Lens Type

Typical Optical-Electrical Characteristics

($I_F=350\text{mA}$, $T_a=25^\circ\text{C}$)

Item	Symbol	Unit	Min	Typ	Max
Peak Wavelength(*)	λ_p	nm	320	325	330
Radiant Flux(**)	P_o	mW	35	50	-
Full Width at Half Maximum	$\Delta\lambda$	nm	-	10	-
Forward voltage	V_F	V	3.8	-	6.2
Viewing Half Angle	$2\theta_{1/2}$	deg.	-	35	-

(*)Peak Wavelength Measurement tolerance is $\pm 3\text{nm}$.

(**)Radiant Flux Measurement tolerance is $\pm 10\%$.

Specification and dimension are subject to change for improvement without notice.

Mechanical Specifications and Exterior photo

Unit : mm

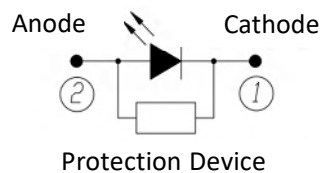
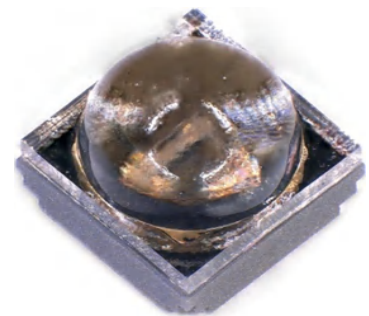
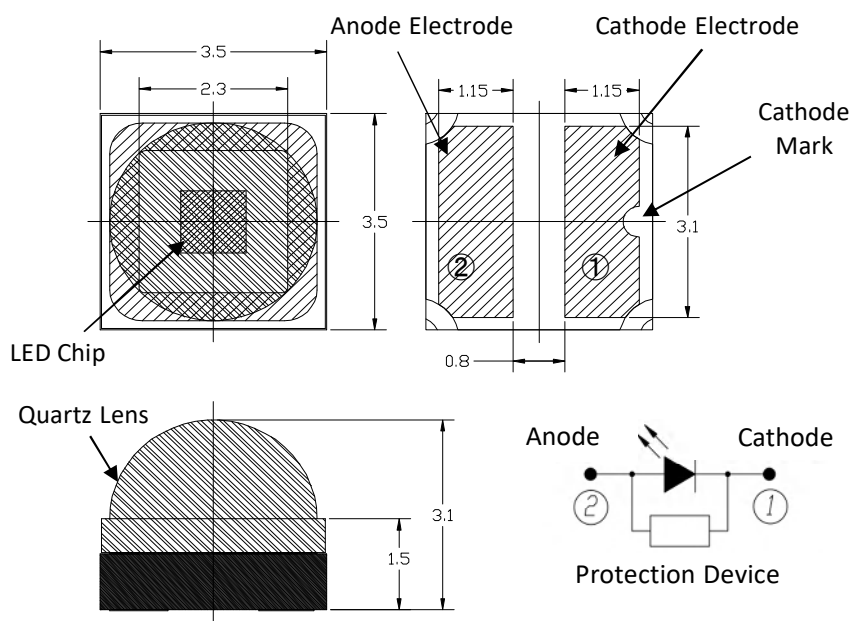

MODEL 325-FL-03-G01

3.5 x 3.5mm Metal Sealed SMD Hemispherical Lens Type

Absolute Maximum Ratings

Item	Symbol	Unit	Value
Forward Current	I_F	mA	600
Reverse Voltage	V_R	V	5
Junction Temperature	T_J	°C	90
Operating Temperature	T_{OPR}	°C	-30 ~ +85
Storage Temperature	T_{STR}	°C	-40 ~ +85 (No condensation)

Derating Curve

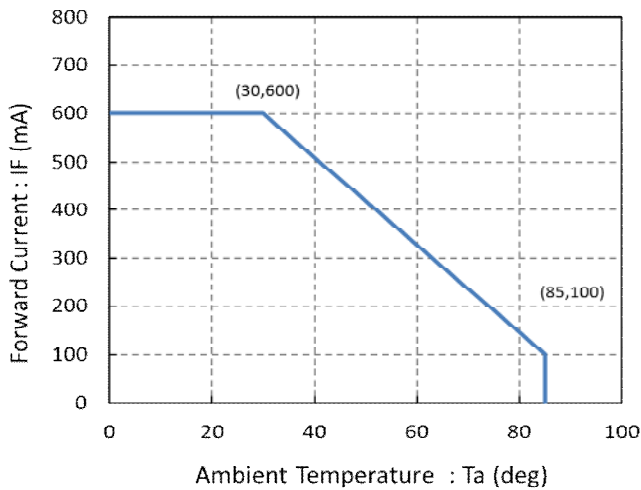

Recommended solder pad

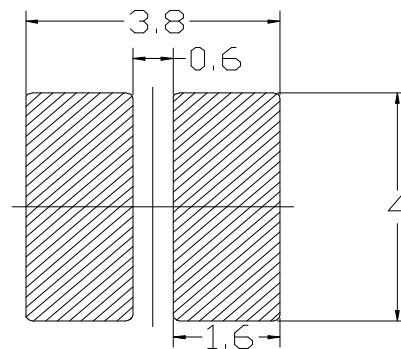

Unit : mm

Reflow soldering profile

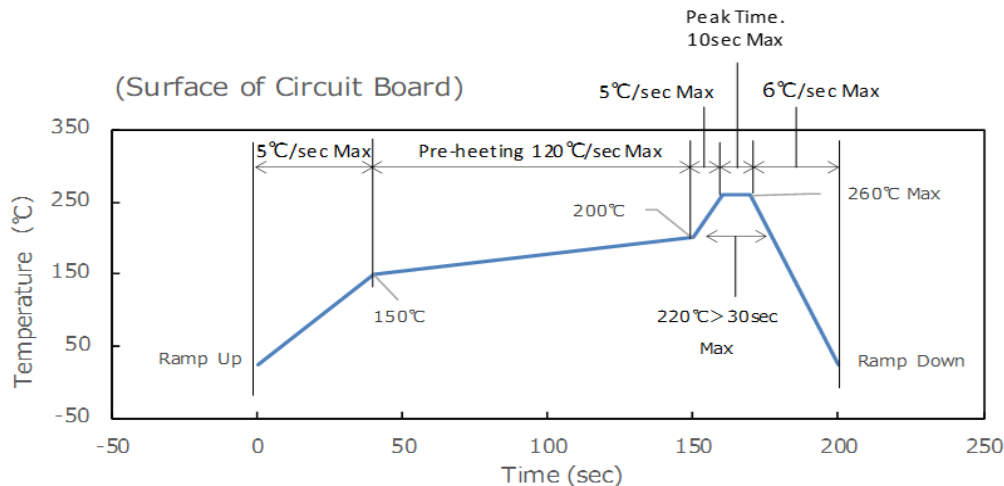

MODEL 325-FL-03-G01

3.5 x 3.5mm Metal Sealed SMD Hemispherical Lens Type

Forward Voltage vs Forward Current

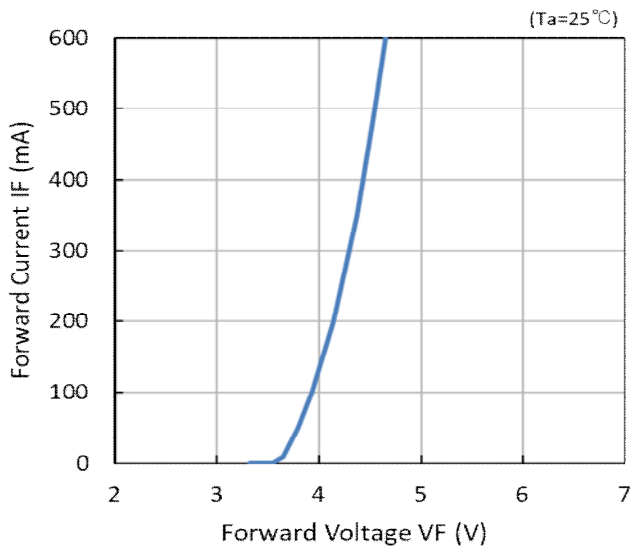

Forward Current vs Radiant Flux

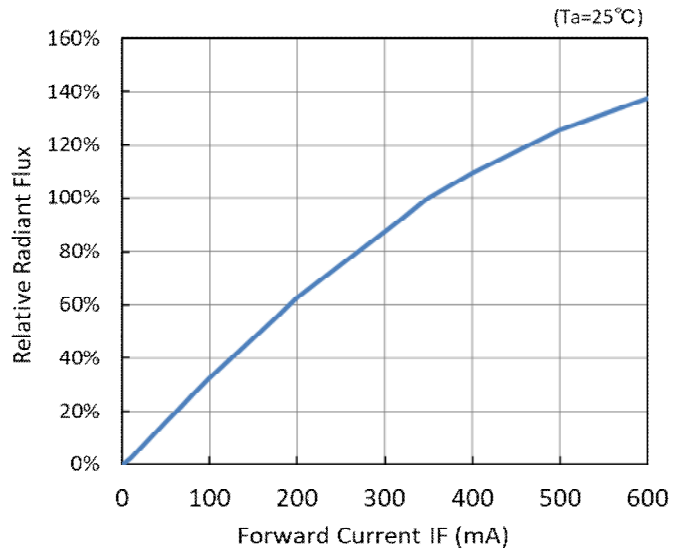

Spectrum

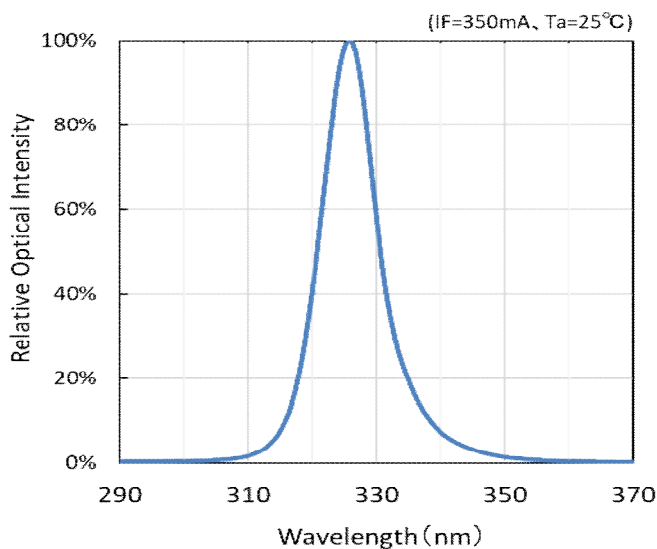

- These data as on the page 3 were determined with Al-substrate on a heat sink and fan.

MODEL 325-FL-03-G01

3.5 x 3.5mm Metal Sealed SMD Hemispherical Lens Type

Radiation Pattern

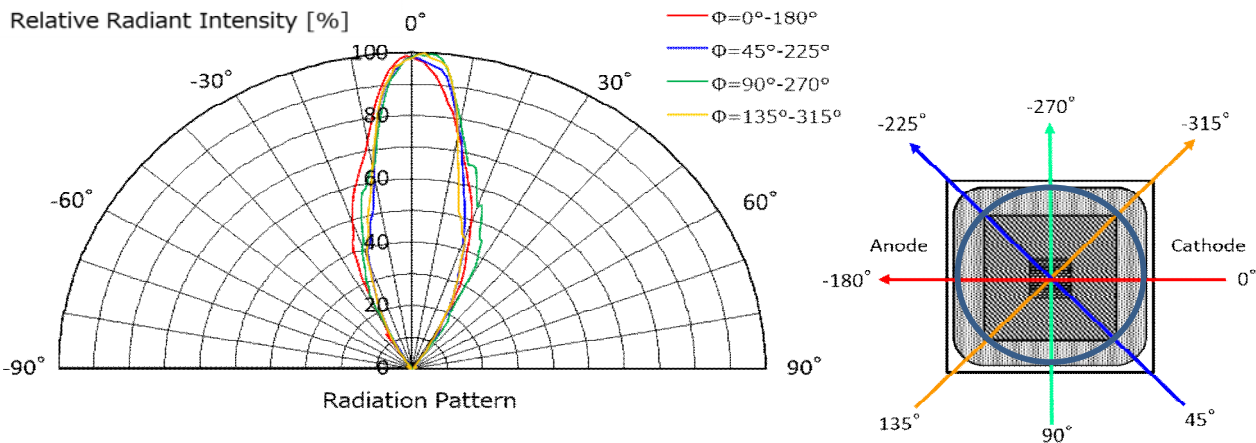

Handling Static Electricity

This product is sensitive to static electricity and surge voltages, which may damage the device and reduce reliability. When handling the product, please refer to the example below and take sufficient measures against static electricity.

- Charge removal using wrist straps, conductive clothing, conductive shoes, conductive flooring, etc.
- Eliminating electric charges by installing equipment, jigs, etc. in the work area.
- Installation of workbenches, storage shelves, etc. using conductive materials.

⚠ WARNING	
	<ul style="list-style-type: none"> • LEDs emit very strong UV radiation. • Do not look at the LED light with the naked eye or irradiate the skin. • UV radiation can harm your eyes and skin. • To prevent UV radiation exposure, wear protective eyewear and protective equipment. • If LEDs are embedded in devices, please indicate warning labels against the UV light LED used. • Keep out of reach of children.