

本目录各项产品颜色因印刷及摄影之故，与实物可能有所差异，请事先了解本目录所有产品，以实物为准。如有更改，恕不另行通知。

Please be aware that all colors of the articles listed herein in the catalogue may differ from that of the real objects due to photography and printing process. All articles listed in the catalogue are subject to the real objects. Should any change, correction and alteration on them be occurred, please be noted that it should not be our obligation to inform you of it.

# Connector

Cabinet hardware connector series



## 金荣达

Jin Rong Da

### 揭阳磐东左钢五金制品厂

JIEYANG PANDONG ZUOGANG HARDWARE PRODUCTS FACTORY

地址：广东省广州市白云区同和街道天健创意园西门3栋106A金荣达  
Office: Jin Rongda, Building 3, West Gate, Tianjian Creative Park,  
Tonghe Street, Baiyun District, Guangzhou City,  
Guangdong Province, China

电话：020-87200220 传真：020-87200890

厂址：揭阳市磐东镇左钢五金厂

Factory: Jieyang Pandong Town Zuogang Hardware Factory



阿里巴巴店铺



微信电子画册



# Connector

Cabinet hardware connector series

橱柜五金连接件系列





# 橱柜五金连接件系列

Cabinet hardware connector series

# Connector

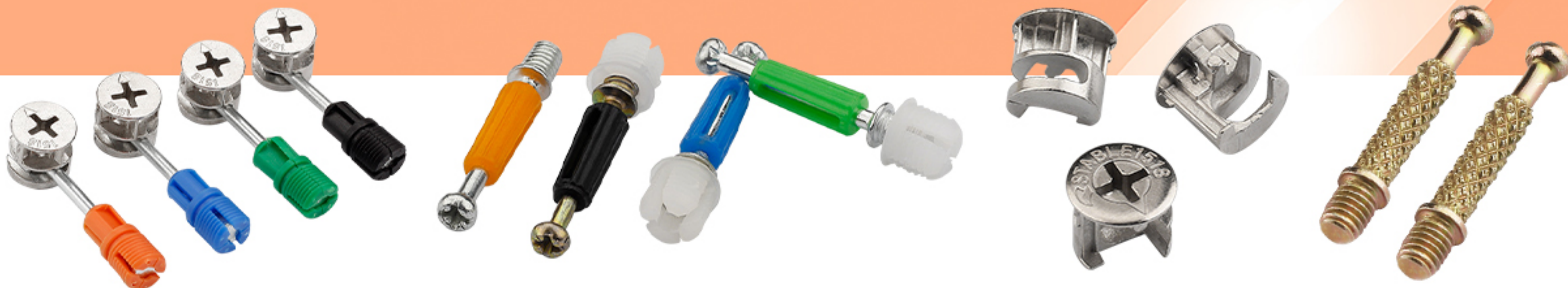



# SALES NETWORK

我们的团队在工作中要求准确到位，管理构架完善。我们强调发扬团队精神，以技术创新，管理创新，创一流产品。以一流的服务，诚信美誉。源源不断地向社会输送优质、安全、可靠、环保、美观。优越的品质，卓越的服务，使每一个环节都有条不紊。鼓励员工与公司共同成长，众志成城！

Our team requires accuracy in their work and a sound management structure. We emphasize to carry forward the team spirit, technology innovation, management innovation, create first-class products. With first-class service, integrity reputation. Continuous delivery of high quality, safety, reliability, environmental protection, beautiful to the society. Superior quality, excellent service, so that every link is orderly. Encourage employees to grow together with the company, united as one!

Enduring Quality

成熟高效的网络销售市场服务，强大便捷的物流体系。

MATURE AND EFFICIENT NETWORK SALES MARKET SERVICES,  
POWERFUL AND CONVENIENT LOGISTICS SYSTEM

经过多年来的经营稳步提升，建立一套成熟高效物流网络市场的服务体系。提供大小货物的一条龙进出口供应链服务，尽可能的为您降低运输成本，以根据客户要求量身打造合适的物流供应链方案，让您省心省力运筹帷幄，产品遍布全球各地，更好地服务各地客商的实际需求，贴心服务好每位顾客，我们期待与您的合作！

After years of steady improvement, the establishment of a set of mature and efficient logistics network market service system. Provide size goods one-stop import and export supply chain services, as far as possible for you to reduce transportation costs, according to customer requirements tailored to create a suitable logistics supply chain solutions, so that you save worry and labor planning, products all over the world, to better serve the actual needs of customers around the world, intimate service every customer, we look forward to working with you!



本目录各项产品颜色因印刷及摄影之故，与实物可能有所差异，请事先了解。本目录所有产品，以实物为准，如有更改，恕不另行通知。  
Color due to the product catalog printing and photography, therefore, may differ from the real thing, please understand.  
All products in this catalog, to prevail in kind, subject to change without notice.

櫥櫃 家具 衣帽間配套五金

2020 PRODUCT MANUAL

櫥櫃 家具 衣帽間配套五金

CABINET FURNITURE  
LOCKER ROOM  
SUPPORTING HARDWARE

European-style boutique pure material  
**High Quality**

橱柜 / 家具 衣帽间  
配套五金

CABINET/FURNITURE  
LOCKER ROOM  
SUPPORTING HARDWARE

我们致力提供客户卓越的服务和  
一站式的采购  
我们遇见改革开放政策在中国释放出巨大的制造潜力  
我们深信制造能力  
是中国在世界经济中的核心价值  
我们亦将继续投资和不断改善  
争取客户完全的满意

We are committed to providing customers with  
excellent service and one-stop  
procurement

We meet the reform and opening policy in China  
to release a huge manufacturing potential!  
We will continue to invest and continue to improve  
Strive for customer satisfaction!



五金主要以开发和经销家具原辅材料、家居装饰材料为主，产品包括铰链、滑道、五金配件、锁具、拉手、厨房五金、定制家具五金产品。利用先进的生产设备、技术、管理水平以及严谨的品质管理保证体系，生产质量一流、适合中国消费者的家居五金产品，如今作为中国家居五金行业的旗舰队伍，依靠强大的品牌拉动，已在中国和国际市场取得了良好的销售业绩以及较高的知名度和市场占有率。

Beikelong mainly deals with the development and distribution of furniture and furnishing materials and home decoration materials. The products include hinges, slideways, and hinges. Hardware accessories, lock, hand, kitchen hardware, custom furniture hardware products. Beikelong uses advanced production equipment. Preparation, technology, management level and strict quality management guarantee system, first-class quality of production, suitable for Chinese consumers home hardware products. Now Beikelong as the flagship of China's home hardware industry, relies on a strong brand, and has been in China and The international market has achieved good sales performance as well as high visibility and market share.



## LIFE 生活

五金精品是人们在享受生活、品味生活的一个构成元素，在生活中不但发挥着合用欣赏和装饰点缀等功能，而且使生活变得多样化，在不同时代、不同文化的文明中体现它的价值，代表着人们热爱生活的一种追求。

Hardware boutique people enjoy life and taste life elements in life not only to play a combination of appreciation and decorative embellishment, and make life more variety in its value, at different times, different cultures and civilizations, embodiesrepresents a pursuit of the people to love life.



## ART 艺术

优秀的五金精品，本身就是一件艺术品，历经了设计师、工程师、技术人员等一大批优秀精英的雕刻细琢，灌注了全副心血、精力，附之于生命，也是人们对它欣赏和使用的肯定，通过时间锤炼的艺术品最终在生活中演绎。

Excellent quality hardware, is itself a work of art, after a large number of excellent designers, engineers, technicians and other elite crafted and perfusion heavily effort, energy, accompanying life, but also it is to appreciate and usesure, artwork temper by the time the final interpretation life.

## TABLE OF CONTENTS



European-style boutique pure material  
**High Quality**

<b>01</b>	连接件系列 Connector series	001
<b>02</b>	铰链系列 Hinge series	019
<b>03</b>	滑轨系列 Slide rail series	039
<b>04</b>	翻门配件系列 Flapper fittings series	061
<b>05</b>	反弹器&缓冲器系列 Spring Back & Buffer series	077
<b>06</b>	吊码系列 Hanging Yard series	087
<b>07</b>	层板托&玻璃夹系列 Laminated Tray & glass clamp series	095

<b>08</b>	配件系列 Accessory series	107
<b>09</b>	衣管配件系列 Clothing pipe fittings series	133
<b>10</b>	移门轮系列 Sliding door wheel series	143
<b>11</b>	拉直器系列 Straightener series	153
<b>12</b>	办公配件系列 Office accessories series	161
<b>13</b>	功能配件系列 Functional accessory series	179

加厚铜层，表面镀镍  
抗氧化能力强，耐腐蚀性好。  
精心挑选锌合金原材料。

Thick copper layer, nickel-plated surface  
Strong oxidation resistance and good corrosion resistance.  
Carefully select zinc alloy raw materials.

## 连接件系列

CONNECTING&FASTNESS FITTING SERIES



连接件系列 Connecting&fastness fitting series

### 连接件系列



连接件系列  
Connecting&fastness fitting series

连接件系列  
Connecting&fastness fitting series



003-1



**主要材质** 锌合金  
**表面处理** 镀锌/镀镍  
**门板厚度** 16/18mm  
Material: Zinc alloy  
Finish: Zinc, Nickel  
Thickness: 16/18mm

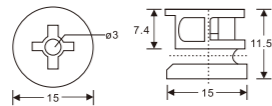

003-2



**主要材质** 锌合金  
**表面处理** 镀锌/镀镍  
**门板厚度** 16/18mm  
Material: Zinc alloy  
Finish: Zinc, Nickel  
Thickness: 16/18mm

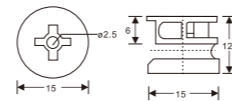

004-1



**主要材质** 锌合金  
**表面处理** 镀锌/镀镍  
**门板厚度** 16/18mm  
Material: Zinc alloy  
Finish: Zinc, Nickel  
Thickness: 16/18mm

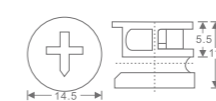

004-2



**主要材质** 锌合金  
**表面处理** 镀锌/镀镍  
**门板厚度** 16/18mm  
Material: Zinc alloy  
Finish: Zinc, Nickel  
Thickness: 16/18mm

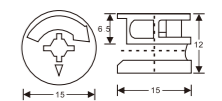

003-3



**主要材质** 锌合金  
**表面处理** 镀锌/镀镍  
**门板厚度** 16/18mm  
Material: Zinc alloy  
Finish: Zinc, Nickel  
Thickness: 16/18mm

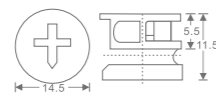

003-4



**主要材质** 锌合金  
**表面处理** 镀锌/镀镍  
**门板厚度** 16/18mm  
Material: Zinc alloy  
Finish: Zinc, Nickel  
Thickness: 16/18mm

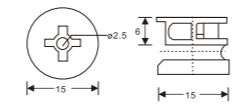

004-3



**主要材质** 锌合金  
**表面处理** 镀锌/镀镍  
**门板厚度** 16/18mm  
Material: Zinc alloy  
Finish: Zinc, Nickel  
Thickness: 16/18mm

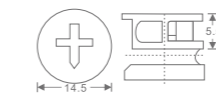

004-4



**主要材质** 锌合金  
**表面处理** 镀锌/镀镍  
**门板厚度** 18mm  
Material: Zinc alloy  
Finish: Zinc, Nickel  
Thickness: 18mm

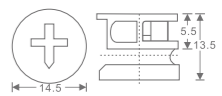

003-5



**主要材质** 锌合金  
**表面处理** 镀锌/镀镍  
**门板厚度** 16/18mm  
Material: Zinc alloy  
Finish: Zinc, Nickel  
Thickness: 16/18mm

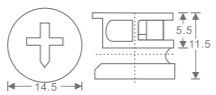

003-6



**主要材质** 锌合金  
**表面处理** 镀锌/镀镍  
**门板厚度** 18mm  
Material: Zinc alloy  
Finish: Zinc, Nickel  
Thickness: 18mm

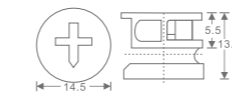

004-5



**主要材质** 锌合金  
**表面处理** 镀锌/镀镍  
**门板厚度** 18mm  
Material: Zinc alloy  
Finish: Zinc, Nickel  
Thickness: 18mm

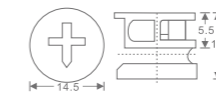

004-6



**主要材质** 锌合金  
**表面处理** 镀锌/镀镍  
**门板厚度** 16/18mm  
Material: Zinc alloy  
Finish: Zinc, Nickel  
Thickness: 16/18mm

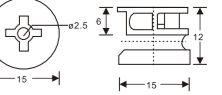

003-7



**主要材质** 锌合金  
**表面处理** 镀锌/镀镍  
**门板厚度** 18mm  
Material: Zinc alloy  
Finish: Zinc, Nickel  
Thickness: 18mm

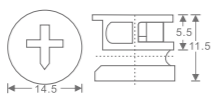

003-8



**主要材质** 锌合金  
**表面处理** 镀锌/镀镍  
**门板厚度** 16/18mm  
Material: Zinc alloy  
Finish: Zinc, Nickel  
Thickness: 16/18mm

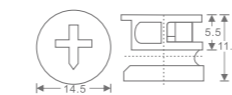

004-7



**主要材质** 锌合金  
**表面处理** 镀锌/镀镍  
**门板厚度** 16/18mm  
Material: Zinc alloy  
Finish: Zinc, Nickel  
Thickness: 16/18mm

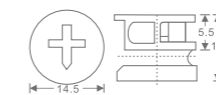

004-8



**主要材质** 锌合金  
**表面处理** 镀锌/镀镍  
**门板厚度** 16/18mm  
Material: Zinc alloy  
Finish: Zinc, Nickel  
Thickness: 16/18mm

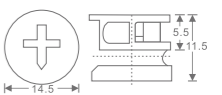

005-1



**主要材质** 锌合金  
**表面处理** 镀锌/镀镍  
**门板厚度** 16/18mm  
Material: Zinc alloy  
Finish: Zinc, Nickel  
Thickness: 16/18mm

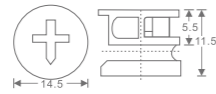

005-2



**主要材质** 锌合金  
**表面处理** 镀锌/镀镍  
**门板厚度** 16/18mm  
Material: Zinc alloy  
Finish: Zinc, Nickel  
Thickness: 16/18mm

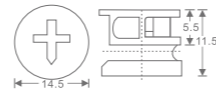

006-1



**主要材质** 铁  
**表面处理** 镀锌/镀镍  
**门板厚度** 16/18mm  
Material: Iron  
Finish: Zinc, Nickel  
Thickness: 16/18mm

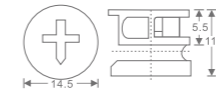

006-2



**主要材质** 铁  
**表面处理** 镀锌/镀镍  
**门板厚度** 16/18mm  
Material: Iron  
Finish: Zinc, Nickel  
Thickness: 16/18mm

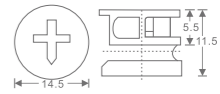

005-3



**主要材质** 锌合金  
**表面处理** 镀锌/镀镍  
**门板厚度** 16/18mm  
Material: Zinc alloy  
Finish: Zinc, Nickel  
Thickness: 16/18mm

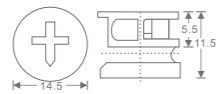

005-4



**主要材质** 锌合金  
**表面处理** 镀锌/镀镍  
**门板厚度** 16/18mm  
Material: Zinc alloy  
Finish: Zinc, Nickel  
Thickness: 16/18mm

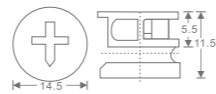

006-3



**主要材质** 铁  
**表面处理** 镀锌/镀镍  
**门板厚度** 16/18mm  
Material: Iron  
Finish: Zinc, Nickel  
Thickness: 16/18mm

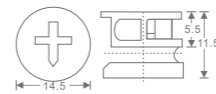

006-4



**主要材质** 锌合金  
**表面处理** 镀锌/镀镍  
**门板厚度** 20/25/30/35mm  
Material: Zinc alloy  
Finish: Zinc, Nickel  
Thickness: 20/25/30/35mm

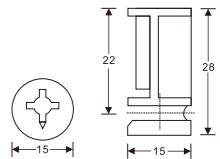

005-5



**主要材质** 锌合金  
**表面处理** 镀锌/镀镍  
**门板厚度** 16/18mm  
Material: Zinc alloy  
Finish: Zinc, Nickel  
Thickness: 16/18mm

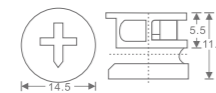

005-6



**主要材质** 锌合金  
**表面处理** 镀锌/镀镍  
**门板厚度** 10-12mm  
Material: Zinc alloy  
Finish: Zinc, Nickel  
Thickness: 10-12mm

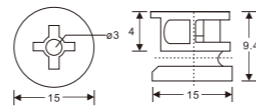

005-7



**主要材质** 锌合金  
**表面处理** 镀锌/镀镍  
**门板厚度** 10-12mm  
Material: Zinc alloy  
Finish: Zinc, Nickel  
Thickness: 10-12mm

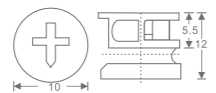

005-8



**主要材质** 锌合金  
**表面处理** 镀锌/镀镍  
**门板厚度** 12mm  
Material: Zinc alloy  
Finish: Zinc, Nickel  
Thickness: 12mm

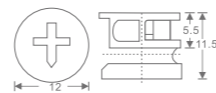

纹理整齐清晰  
定位精准，结实耐用  
连接稳定不松脱

The texture is neat and clear  
Accurate positioning, strong and durable  
The connection is stable and not loose



连接件系列  
Connecting&fastness fitting series

连接件系列  
Connecting&fastness fitting series

008-1



**主要材质** 铁+塑料  
**表面处理** 镀锌/镀彩  
**产品规格** 32/35/40 mm  
Material: Steel+Plastic  
Finish: Galvanized/plating color  
Size: 32/35/40 mm

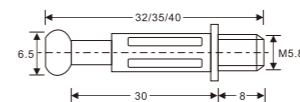

008-2



**主要材质** 铁+塑料  
**表面处理** 镀锌/镀彩  
**产品规格** 32/35/40 mm  
Material: Steel+Plastic  
Finish: Galvanized/plating color  
Size: 32/35/40 mm

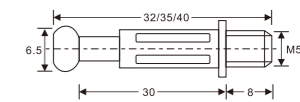

008-3



**主要材质** 铁+塑料  
**表面处理** 镀锌/镀彩  
**产品规格** 32/35/40 mm  
Material: Steel+Plastic  
Finish: Galvanized/plating color  
Size: 32/35/40 mm

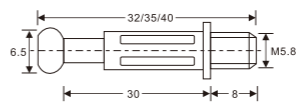

008-4



**主要材质** 铁+塑料  
**表面处理** 镀锌/镀彩  
**产品规格** 32/35/40 mm  
Material: Steel+Plastic  
Finish: Galvanized/plating color  
Size: 32/35/40 mm

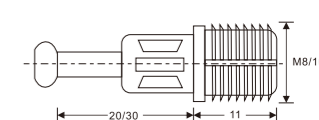

008-5



**主要材质** 铁+塑料  
**表面处理** 镀锌+黑色  
**产品规格** M8×L32/42 mm  
M10×L32/42 mm  
Material: Steel+Plastic  
Finish: Zinc+Black  
Size: M8×L32/42 mm  
M10×L32/42 mm

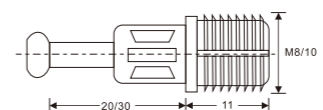

008-6



**主要材质** 铁+塑料  
**表面处理** 镀锌+绿色  
**产品规格** M8×L32/42 mm  
M10×L32/42 mm  
Material: Steel+Plastic  
Finish: Zinc+Green  
Size: M8×L32/42 mm  
M10×L32/42 mm

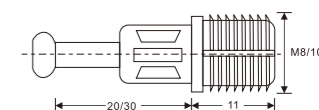

008-7



**主要材质** 铁+塑料  
**表面处理** 镀锌+红色  
**产品规格** M8×L32/42 mm  
M10×L32/42 mm  
Material: Steel+Plastic  
Finish: Zinc+Red  
Size: M8×L32/42 mm  
M10×L32/42 mm

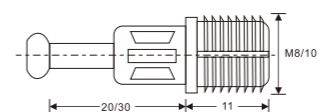

008-8



**主要材质** 铁+塑料  
**表面处理** 镀锌/镀彩  
**产品规格** 32/35/40 mm  
Material: Steel+Plastic  
Finish: Galvanized/plating color  
Size: 32/35/40 mm

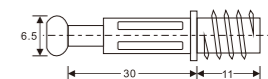

009-1



**主要材质** 铁+塑料  
**表面处理** 镀锌/镀彩  
**产品规格** 32/35/40 mm  
 Material: Steel+Plastic  
 Finish: Galvanized/plating color  
 Size: 32/35/40 mm

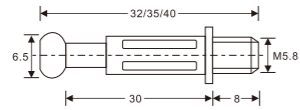

009-2



**主要材质** 铁+塑料  
**表面处理** 镀锌/镀彩  
**产品规格** 32/35/40 mm  
 Material: Steel+Plastic  
 Finish: Galvanized/plating color  
 Size: 32/35/40 mm

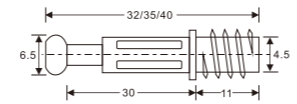

010-1



**主要材质** 铁+塑料  
**表面处理** 镀锌/镀彩  
**产品规格** 32/35/40 mm  
 Material: Steel+Plastic  
 Finish: Galvanized/plating color  
 Size: 32/35/40 mm

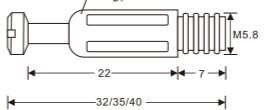

010-2



**主要材质** 铁+塑料  
**表面处理** 镀锌/镀彩  
**产品规格** 32/35/40 mm  
 Material: Steel+Plastic  
 Finish: Galvanized/plating color  
 Size: 32/35/40 mm

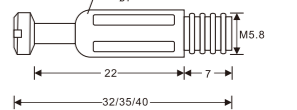

009-3



**主要材质** 铁+塑料  
**表面处理** 镀锌/镀彩  
**产品规格** 32/35/40 mm  
 Material: Steel+Plastic  
 Finish: Galvanized/plating color  
 Size: 32/35/40 mm

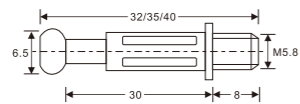

009-4



**主要材质** 铁+塑料  
**表面处理** 镀锌/镀彩  
**产品规格** 32/35/40 mm  
 Material: Steel+Plastic  
 Finish: Galvanized/plating color  
 Size: 32/35/40 mm

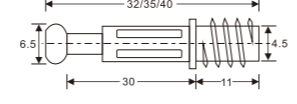

010-3



**主要材质** 铁  
**表面处理** 镀锌/镀彩  
**产品规格** 32/35/40 mm  
 Material: Steel  
 Finish: Galvanized/plating color  
 Size: 32/35/40 mm

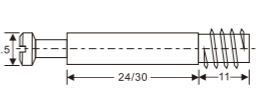

010-4



**主要材质** 铁  
**表面处理** 镀锌/镀彩  
**产品规格** 32/35/40 mm  
 Material: Steel  
 Finish: Galvanized/plating color  
 Size: 32/35/40 mm

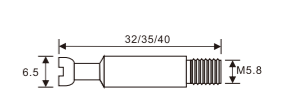

009-5



**主要材质** 铁+塑料  
**表面处理** 镀锌/镀彩  
**产品规格** 32/35/40 mm  
 Material: Steel+Plastic  
 Finish: Galvanized/plating color  
 Size: 32/35/40 mm

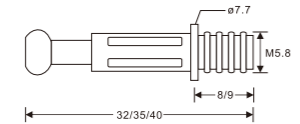

009-6



**主要材质** 铁+塑料  
**表面处理** 镀锌/镀彩  
**产品规格** 32/35/40 mm  
 Material: Steel+Plastic  
 Finish: Galvanized/plating color  
 Size: 32/35/40 mm

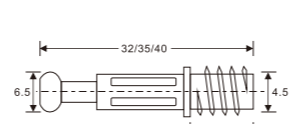

010-5



**主要材质** 铁  
**表面处理** 镀锌/镀彩  
**产品规格** 32/35/40 mm  
 Material: Steel  
 Finish: Galvanized/plating color  
 Size: 32/35/40 mm

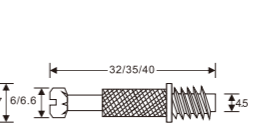

010-6



**主要材质** 铁  
**表面处理** 镀锌/镀彩  
**产品规格** 32/35/40 mm  
 Material: Steel  
 Finish: Galvanized/plating color  
 Size: 32/35/40 mm

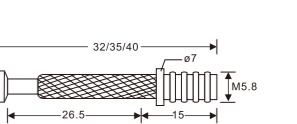

009-7



**主要材质** 铁+塑料  
**表面处理** 镀锌/镀彩  
**产品规格** 32/35/40 mm  
 Material: Steel+Plastic  
 Finish: Galvanized/plating color  
 Size: 32/35/40 mm

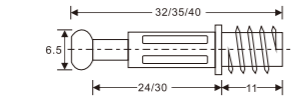

009-8



**主要材质** 铁+塑料  
**表面处理** 镀锌/镀彩  
**产品规格** 32/35/40 mm  
 Material: Steel+Plastic  
 Finish: Galvanized/plating color  
 Size: 32/35/40 mm

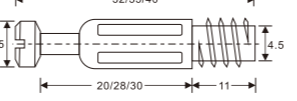

010-7



**主要材质** 铁  
**表面处理** 镀锌/镀彩  
**产品规格** 32/35/40 mm  
 Material: Steel  
 Finish: Galvanized/plating color  
 Size: 32/35/40 mm

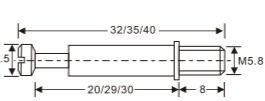

010-8



**主要材质** 铁  
**表面处理** 镀锌/镀彩  
**产品规格** 32/35/40 mm  
 Material: Steel  
 Finish: Galvanized/plating color  
 Size: 32/35/40 mm

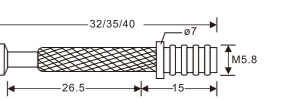

011-1



**主要材质** 铁  
**表面处理** 镀锌/镀彩  
**产品规格** 32/35/40 mm  
Material: Steel  
Finish: Galvanized/plating color  
Size: 32/35/40 mm

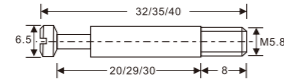

011-2



**主要材质** 铁  
**表面处理** 镀锌/镀彩  
**产品规格** 32/35/40 mm  
Material: Steel  
Finish: Galvanized/plating color  
Size: 32/35/40 mm

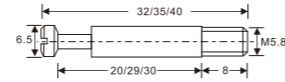

012-1



**主要材质** 铁+塑料  
**表面处理** 镀锌+白色  
**产品规格** M6×41 mm  
Material: Steel+Plastic  
Finish: Zinc+White  
Size: M6×41 mm

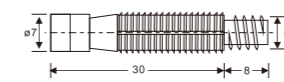

012-2



**主要材质** 铁+塑料  
**表面处理** 镀锌+红色  
**产品规格** M6×41 mm  
Material: Steel+Plastic  
Finish: Zinc+Red  
Size: M6×41 mm

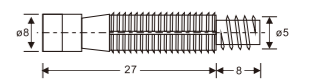

011-3



**主要材质** 铁  
**表面处理** 镀锌  
**产品规格** 15/16mm  
Material: Steel  
Finish: Zinc  
Size: M6×L31/41 mm

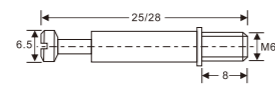

011-4



**主要材质** 铁  
**表面处理** 镀锌  
**产品规格** 15/16mm  
Material: Steel  
Finish: Zinc  
Size: M6×L31/41 mm

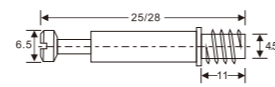

012-3



**主要材质** 塑料  
**表面处理** 白色/绿色  
Material: Plastic  
Finish: White/Green  
6000个/箱  
5000/10000 pcs/ctn

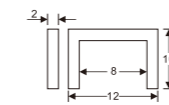

012-4



**主要材质** 塑料  
**表面处理** 黑色  
Material: Plastic  
Finish: Black

011-5



**主要材质** 铁  
**表面处理** 镀锌  
**产品规格** 47mm  
Material: Steel  
Finish: Zinc  
Size: 47 mm

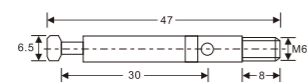

011-6



**主要材质** 铁  
**表面处理** 镀锌/镀彩  
**产品规格** Φ7×84 mm  
Material: Steel  
Finish: Zinc  
Size: Φ7×84 mm

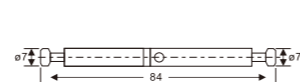

012-5



**主要材质** 铁  
**表面处理** 镀锌  
**产品规格** 8×41/51 mm  
Material: Steel  
Finish: Zinc  
Size: 8×41/51 mm

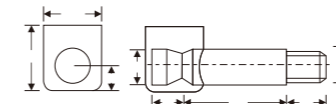

012-6



**主要材质** 铁  
**表面处理** 镀锌  
**产品规格** -----  
Material: Steel  
Finish: Zinc

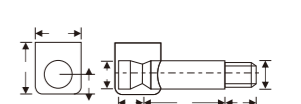

011-7



**主要材质** 铁  
**表面处理** 镀锌  
**产品规格** 48/60/64/68/72/80/84 mm  
Material: Steel  
Finish: Zinc  
Size: 48/60/64/68/72/80/84 mm

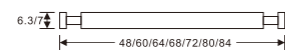

011-8



**主要材质** 铁  
**表面处理** 镀锌  
**产品规格** 51mm  
Material: Steel  
Finish: Zinc  
Size: 51mm

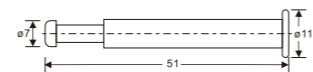

012-7



**主要材质** 锌合金  
**表面处理** 镀锌/镀镍  
**产品规格** M6×12/17 mm  
M8×17 mm  
Material: Zinc alloy  
Finish: Zinc/Nickel  
Size: M6×12/17 mm  
M8×17 mm

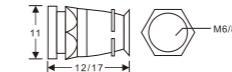

012-8



**主要材质** 锌合金  
**表面处理** 镀锌/镀镍  
**产品规格** M6×12/17 mm  
M8×17 mm  
Material: Zinc alloy  
Finish: Zinc/Nickel  
Size: M6×12/17 mm  
M8×17 mm



013-1



**主要材质** PVC/尼龙  
**表面处理** 白色  
**产品规格**  $\Phi 5.5 \times 10/12$  mm  
Material: PVC/Nylon  
Finish: White  
Size:  $\Phi 5.5 \times 10/12$  mm

013-2



**主要材质** PVC/尼龙  
**表面处理** 白色  
**产品规格**  $\Phi 5.5 \times 10/12$  mm  
Material: PVC/Nylon  
Finish: White  
Size:  $\Phi 5.5 \times 10/12$  mm

014-1



**主要材质** PVC/尼龙  
**表面处理** 红色  
**产品规格**  $10 \times 16/18$  mm  
Material: PVC/Nylon  
Finish: Red  
Size:  $10 \times 16/18$  mm

014-2



**主要材质** PVC/尼龙  
**表面处理** 白色  
**产品规格**  $10 \times 16/18$  mm  
Material: PVC/Nylon  
Finish: White  
Size:  $10 \times 16/18$  mm

013-3



**主要材质** PVC/尼龙  
**表面处理** 白色  
**产品规格**  $\Phi 11 \times 10.5/10.8/11$  mm  
Material: PVC/Nylon  
Finish: White  
Size:  $\Phi 11 \times 10.5/10.8/11$  mm

013-4



**主要材质** PVC/尼龙  
**表面处理** 白色  
**产品规格**  $\Phi 11 \times 9/10.5/12$  mm  
Material: PVC/Nylon  
Finish: White  
Size:  $\Phi 11 \times 9/10.5/12$  mm

014-3



**主要材质** 锌合金  
**表面处理** 镀锌/镀镍  
**产品规格** 15/16mm  
Material: Zinc alloy  
Finish: Zinc, Nickel  
Size: 15/16 mm

014-4



**主要材质** 铁+塑料  
**表面处理** 镀锌/镀镍  
**产品规格** 15/16mm  
Material: Steel+Plastic  
Finish: Zinc, Nickel  
Size: 15/16 mm

013-5



**主要材质** PVC/尼龙  
**表面处理** 白色  
**产品规格**  $\Phi 11 \times 9/10.5/12$  mm  
Material: PVC/Nylon  
Finish: White  
Size:  $\Phi 11 \times 9/10.5/12$  mm

013-6



**主要材质** PVC/尼龙  
**表面处理** 白色  
**产品规格**  $\Phi 11 \times 10.5/10.8/11$  mm  
Material: PVC/Nylon  
Finish: White  
Size:  $\Phi 11 \times 10.5/10.8/11$  mm

014-5



**主要材质** 锌合金  
**表面处理** 镀锌  
**产品规格**  $M6 \times L10/13/18$  mm  
 $M8 \times L13/15/20$  mm  
Material: Zinc alloy  
Finish: Color zinc  
Size:  $M6 \times L10/13/18/20$  mm  
 $M8 \times L13/15/20/25$  mm

014-6

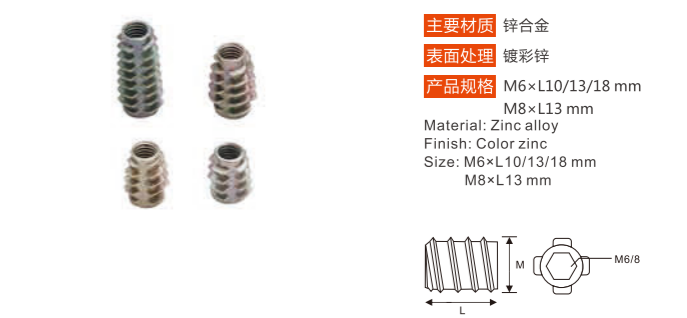

**主要材质** 锌合金  
**表面处理** 镀锌  
**产品规格**  $M6 \times L10/13/18$  mm  
 $M8 \times L13$  mm  
Material: Zinc alloy  
Finish: Color zinc  
Size:  $M6 \times L10/13/18$  mm  
 $M8 \times L13$  mm

013-7



**主要材质** PVC/尼龙  
**表面处理** 绿色  
**产品规格**  $\Phi 11 \times 10.5/10.8/11$  mm  
Material: PVC/Nylon  
Finish: Green  
Size:  $\Phi 11 \times 10.5/10.8/11$  mm

013-8



**主要材质** PVC/尼龙  
**表面处理** 红色  
**产品规格**  $\Phi 11 \times 10.5/10.8/11$  mm  
Material: PVC/Nylon  
Finish: Red  
Size:  $\Phi 11 \times 10.5/10.8/11$  mm

014-7



**主要材质** 铁  
**表面处理** 镀锌  
**产品规格**  $M6 \times 10/13/14/15/17/20/25$  mm  
 $M8 \times 13/14/15/17/20/22/25/30$  mm  
Material: Steel  
Finish: Zinc  
Size:  $M6 \times 10/13/14/15/17/20/25$  mm  
 $M8 \times 13/14/15/17/20/22/25/30$  mm

014-8



**主要材质** 铁  
**表面处理** 彩锌  
**产品规格**  $M6 \times 8/10/13/15/17/20/25$  mm  
 $M8 \times L12/14/15/17/20/22/25/30$  mm  
 $M10 \times L15/20/25$  mm  
Material: Steel  
Finish: Color zinc  
Size:  $M6 \times 8/10/13/15/17/20/25$  mm  
 $M8 \times L12/14/15/17/20/22/25/30$  mm  
 $M10 \times L15/20/25$  mm

015-1



**主要材质** 铁  
**表面处理** 彩锌  
**产品规格** M6×L13/15/20/25 mm  
M8×L15/20/25/30 mm  
M10×L20/25/30 mm

Material: Steel  
Finish: Color zinc  
Size: M6×L13/15/20/25 mm  
M8×L15/20/25/30 mm  
M10×L20/25/30 mm



015-2



**主要材质** 铁  
**表面处理** 彩锌  
**产品规格** M6×L13/15/20/25 mm  
M8×L15/20/25/30 mm  
M10×L20/25/30 mm

Material: Steel  
Finish: Color zinc  
Size: M6×L13/15/20/25 mm  
M8×L15/20/25/30 mm  
M10×L20/25/30 mm

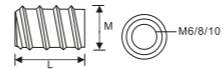

016-1



**主要材质** 铁  
**表面处理** 镀镍/镀彩  
**产品规格** M6×8×12/15/  
18/20 mm

Material: Stainless steel  
Finish: Nickel/Color zinc  
Size: M6×8×12/15/18/20 mm

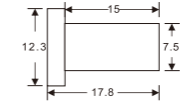

016-2



**主要材质** 铁  
**表面处理** 镀镍/镀彩  
**产品规格** M6×8×12/15/  
18/20 mm

Material: Stainless steel  
Finish: Nickel/Color zinc  
Size: M6×8×12/15/18/20 mm

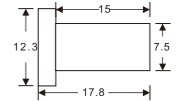

015-3



**主要材质** 铁  
**表面处理** 彩锌

Material: Steel  
Finish: Colorful Zinc

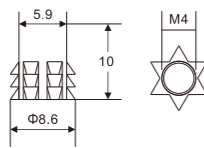

015-4



**主要材质** 铁  
**表面处理** 彩锌  
**产品直径** M8/10

Material: Steel  
Finish: Colorful Zinc  
Diameter: M8/10

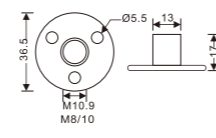

016-3



**主要材质** 铁  
**表面处理** 镀镍  
**产品规格** 6×19/8×21 mm

Material: Steel  
Finish: Nickel  
Size: 6×19/8×21 mm

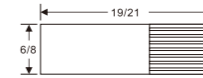

016-4



**主要材质** 铁  
**表面处理** 镀镍  
**产品规格** 6×19/8×21 mm

Material: Steel  
Finish: Nickel  
Size: 6×19/8×21 mm

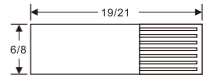

015-5



**主要材质** 铁  
**表面处理** 镀镍  
**产品规格** 5×29/27-M4×15mm

Material: Steel  
Finish: Nickel  
Size: 5×29/27-M4×15mm

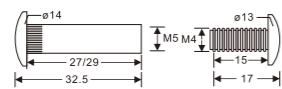

015-6



**主要材质** 铁  
**表面处理** 镀镍  
**产品规格** 5×29/27-M4×15mm

Material: Steel  
Finish: Nickel  
Size: 5×29/27-M4×15mm

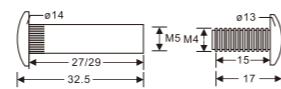

016-5



**主要材质** 锌合金  
**表面处理** 金色  
**产品规格** 8×18/23/30/  
9×18/23 mm

Material: Zinc alloy  
Finish: Golden  
Size: 8×18/23/30/  
9×18/23 mm

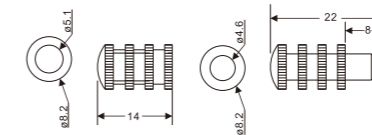

016-6



**主要材质** 铁  
**表面处理** 镀镍  
**产品规格** 8×18/23/30/  
9×18/23 mm

Material: Steel  
Finish: Nickel  
Size: 8×18/23/30/  
9×18/23 mm

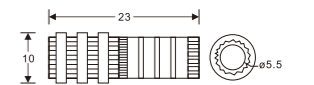

015-7



**主要材质** 铁+塑料  
**表面处理** 黑色/棕色/白色  
**产品规格** M8

Material: Steel+Plastic  
Finish: Black/brown  
Size: M8

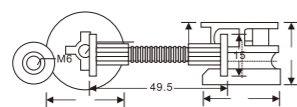

015-8



**主要材质** 不锈钢  
**表面处理** 原色  
**产品规格** M6×8×12/15/  
18/20 mm

Material: Stainless steel  
Finish: Primary colour  
Size: M6×8×12/15/18/20 mm

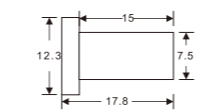

016-7



**主要材质** 锌合金  
**表面处理** 金色  
**产品规格** 8×18/23/30/  
9×18/23 mm

Material: Zinc alloy  
Finish: Golden  
Size: 8×18/23/30/  
9×18/23 mm

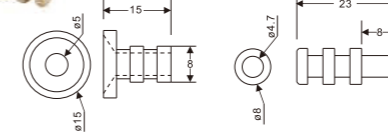

017-1



主要材质 铁  
表面处理 镀锌/镀彩/镀铬/镀黑  
Material: Steel  
Finish: Zinc



017-2



主要材质 铁  
表面处理 镀锌/镀彩/镀铬/镀黑  
Material: Steel  
Finish: Zinc

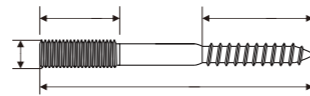

018-1



主要材质 铁  
表面处理 镀锌/镀彩/镀铬/镀黑  
Material: Steel  
Finish: Zinc

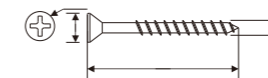

018-2



主要材质 铁  
表面处理 镀锌/镀彩/镀铬/镀黑  
Material: Steel  
Finish: Zinc

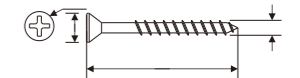

017-3



主要材质 铁  
表面处理 镀锌/镀彩/镀铬/镀黑  
Material: Steel  
Finish: Zinc

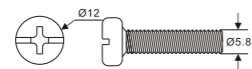

017-4



主要材质 铁  
表面处理 镀锌/镀彩/镀铬/镀黑  
Material: Steel  
Finish: Zinc

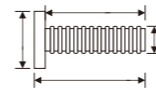

018-3



主要材质 铁  
表面处理 镀锌/镀彩/镀铬/镀黑  
Material: Steel  
Finish: Zinc

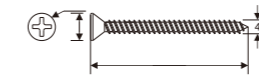

018-4



主要材质 铁  
表面处理 镀锌/镀彩/镀铬/镀黑  
Material: Steel  
Finish: Zinc

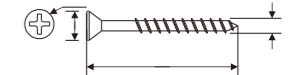

017-5



主要材质 铁  
表面处理 镀锌/镀彩/镀铬/镀黑  
Material: Steel  
Finish: Zinc

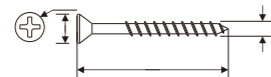

017-6



主要材质 铁  
表面处理 镀锌/镀彩/镀铬/镀黑  
Material: Steel  
Finish: Zinc

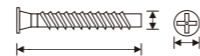

018-5



主要材质 铁  
表面处理 镀锌/镀彩/镀铬/镀黑  
Material: Steel  
Finish: Zinc

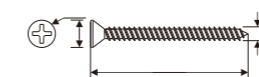

018-6



主要材质 铁  
表面处理 镀锌/镀彩/镀铬/镀黑  
Material: Steel  
Finish: Zinc

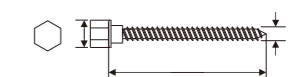

017-7



主要材质 铁  
表面处理 镀锌/镀彩/镀铬/镀黑  
Material: Steel  
Finish: Zinc

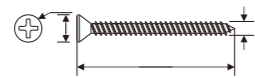

017-8



主要材质 铁  
表面处理 镀锌/镀彩/镀铬/镀黑  
Material: Steel  
Finish: Zinc

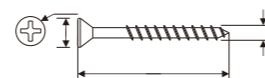

018-7



主要材质 锌合金  
表面处理 镀锌  
产品规格 15×31mm  
Material: Zinc Alloy  
Finish: Zinc  
Size: 15×31 mm

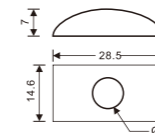

018-8



主要材质 铁  
表面处理 镀锌/镀彩/镀铬/镀黑  
Material: Steel  
Finish: Zinc

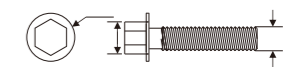



阻尼缓冲静音  
高品质,低分贝  
寿命长久相伴一生

Damping buffer mute  
High quality, low decibel  
Long life span

铰链系列  
Hinge series

铰链系列  
HINGE SERIES



钻石品质 服务一流 时尚外观

铰链系列 Hinge series

铰链系列



262 二段力冷轧钢缓冲铰链  
P021



262 一段力冷轧钢缓冲铰链  
P022



661 一段力冷轧钢缓冲铰链  
P023



588 一段力冷轧钢缓冲铰链  
P024



581 一段力冷轧钢缓冲铰链  
P025



一段力不锈钢缓冲铰链  
P026



一段力不锈钢缓冲铰链  
P027



262 三维缓冲铰链  
P028



铝框缓冲铰链(镀铬)  
P029



铝框缓冲铰链(枪黑)  
P030



35杯玻璃门缓冲铰链  
P031



短臂缓冲铰链  
P032



3寸/4寸/4寸缓冲 弹子铰  
P033



165°缓冲铰链  
P034



多角度铰链(缓冲/普通)  
P035



多角度铰链  
P036



无弹力反弹铰链  
P037



左右铰链  
P038

铰链灯  
P038

铰链系列  
Hinge series



**262 二段力冷轧钢缓冲铰链**  
262 Cold rolled steel cushion hinge 2 force

产品信息  
Information

开启角度：105度  
Opening angle:105°

铰杯厚度：11.3毫米  
Depth of hinge cup:11.3mm

铰杯直径：35毫米  
Diameter of hinge cup:35mm

可选门板厚度：14-22毫米  
Range of door thickness:14-22mm

主要材质：冷轧钢  
Material: Cold rolled steel

可配底座 (Plate) :

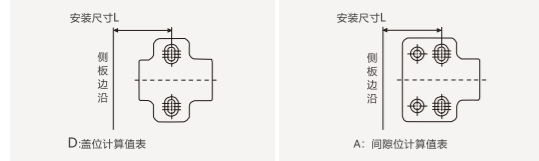

铰杯种类 (Hinge cup types)

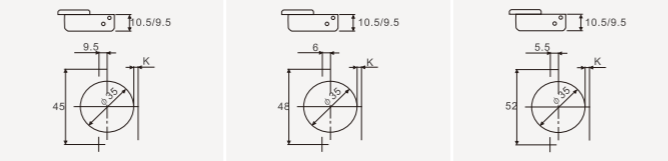

直弯

(Full-overlay 全盖)

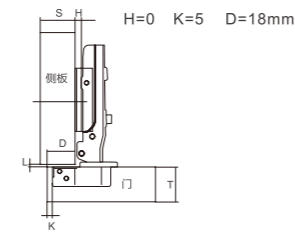

	3	4	5	6	7
0	17	18	19	20	21
2	15	16	17	18	19
4	13	14	15	16	17



**262 一段力冷轧钢缓冲铰链**  
262 A cold rolling cushion hinge

产品信息  
Information

开启角度：105度  
Opening angle:105°

铰杯厚度：11.3毫米  
Depth of hinge cup:11.3mm

铰杯直径：35毫米  
Diameter of hinge cup:35mm

可选门板厚度：14-22毫米  
Range of door thickness:14-22mm

主要材质：冷轧钢  
Material: Cold rolled steel

可配底座 (Plate) :

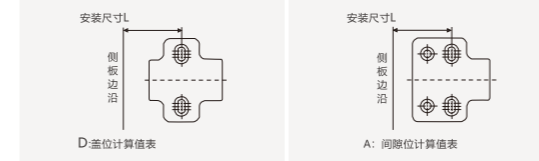

铰杯种类 (Hinge cup types)

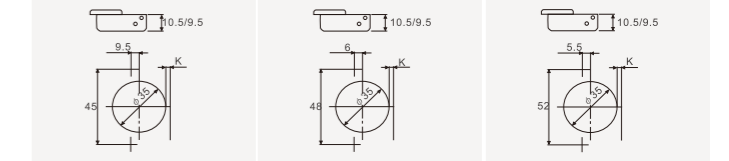

直弯

(Full-overlay 全盖)

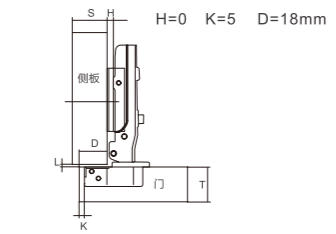

	3	4	5	6	7
0	17	18	19	20	21
2	15	16	17	18	19
4	13	14	15	16	17



中弯

(Half cover 半盖)

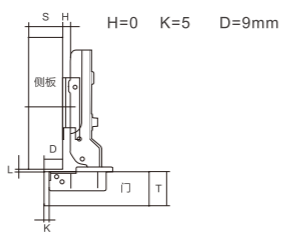

	3	4	5	6	7
0	8	9	10	11	12
2	6	7	8	9	10
4	4	5	6	7	8



中弯

(Half cover 半盖)

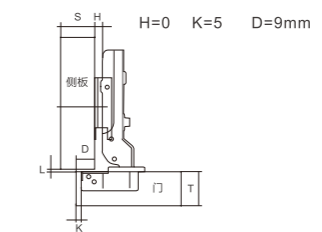

	3	4	5	6	7
0	8	9	10	11	12
2	6	7	8	9	10
4	4	5	6	7	8



大弯

(Inside 内侧)

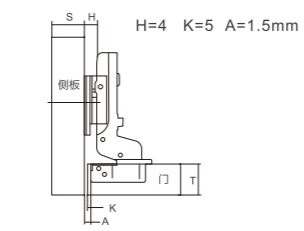

	3	4	5	6	7
0	1	0	-1	-2	-3
2	3	2	1	0	-1
4	5	4	3	2	1



大弯

(Inside 内侧)

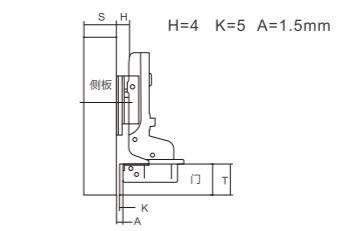

	3	4	5	6	7
0	1	0	-1	-2	-3
2	3	2	1	0	-1
4	5	4	3	2	1



**661 一段力冷轧钢缓冲铰链**  
661 A cold rolling cushion hinge

产品信息  
Information

开启角度：105度  
Opening angle:105°

铰杯厚度：11.3毫米  
Depth of hinge cup:11.3mm

铰杯直径：35毫米  
Diameter of hinge cup:35mm

可选门板厚度：14-20毫米  
Range of door thickness:14-20mm

主要材质：冷轧钢  
Material: Cold rolled steel

可配底座 (Plate) :

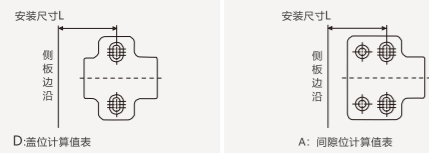

铰杯种类 (Hinge cup types)

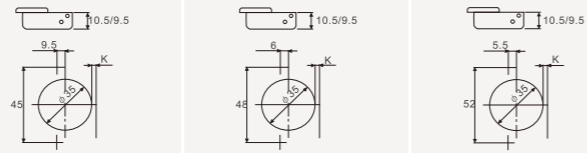

直弯

(Full-overlay 全盖)

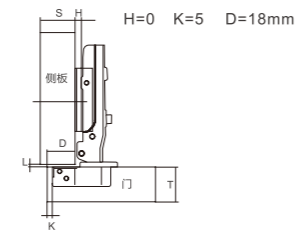

	3	4	5	6	7
0	17	18	19	20	21
2	15	16	17	18	19
4	13	14	15	16	17



**588 一段力冷轧钢缓冲铰链**  
588 A cold rolling cushion hinge

产品信息  
Information

开启角度：105度  
Opening angle:105°

铰杯厚度：9.5毫米  
Depth of hinge cup:9.5mm

铰杯直径：35毫米  
Diameter of hinge cup:35mm

可选门板厚度：14-20毫米  
Range of door thickness:14-20mm

主要材质：冷轧钢  
Material: Cold rolled steel

可配底座 (Plate) :

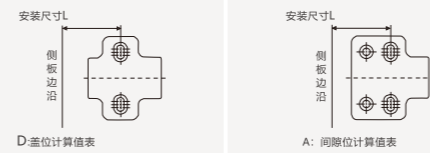

铰杯种类 (Hinge cup types)

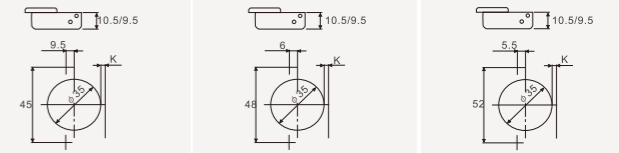

直弯

(Full-overlay 全盖)

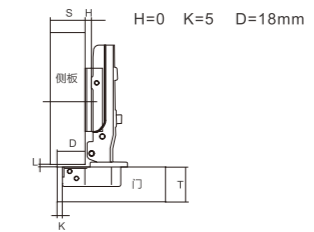

	3	4	5	6	7
0	17	18	19	20	21
2	15	16	17	18	19
4	13	14	15	16	17



中弯

(Half cover 半盖)

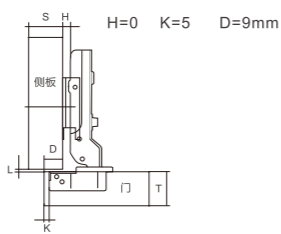

	3	4	5	6	7
0	8	9	10	11	12
2	6	7	8	9	10
4	4	5	6	7	8



中弯

(Half cover 半盖)

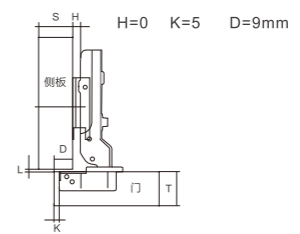

	3	4	5	6	7
0	8	9	10	11	12
2	6	7	8	9	10
4	4	5	6	7	8



大弯

(Inside 内侧)

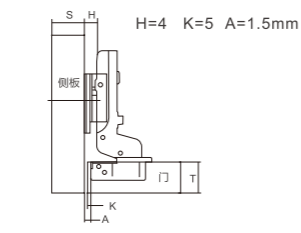

	3	4	5	6	7
0	1	0	-1	-2	-3
2	3	2	1	0	-1
4	5	4	3	2	1



大弯

(Inside 内侧)

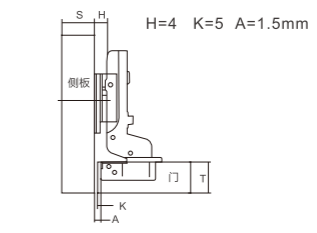

	3	4	5	6	7
0	1	0	-1	-2	-3
2	3	2	1	0	-1
4	5	4	3	2	1



**581 一段力冷轧钢缓冲铰链**  
581 A cold rolling cushion hinge

产品信息  
Information

开启角度：105度  
Opening angle:105°

铰杯厚度：9.5毫米  
Depth of hinge cup:9.5mm

铰杯直径：35毫米  
Diameter of hinge cup:35mm

可选门板厚度：14-18毫米  
Range of door thickness:14-18mm

主要材质：冷轧钢  
Material: Cold rolled steel



**一段力不锈钢缓冲铰链**  
A stainless steel cushion hinge

产品信息  
Information

开启角度：105度  
Opening angle:105°

铰杯厚度：11.3毫米  
Depth of hinge cup:11.3mm

铰杯直径：35毫米  
Diameter of hinge cup:35mm

可选门板厚度：14-25毫米  
Range of door thickness:14-25mm

主要材质：不锈钢(201/304)  
Material: Stainless steel(201/304)

可配底座 (Plate) :

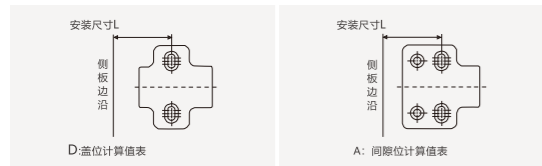

铰杯种类 (Hinge cup types)

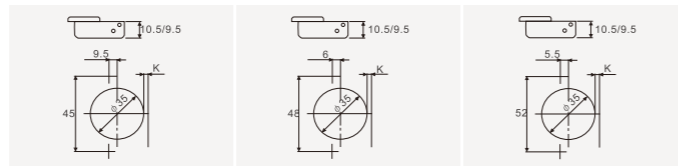

可配底座 (Plate) :

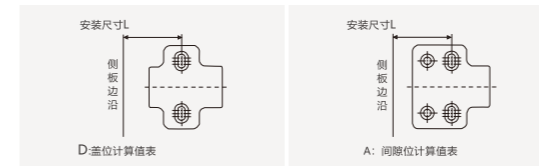

铰杯种类 (Hinge cup types)

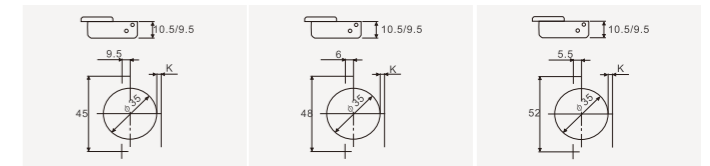

直弯

(Full-overlay 全盖)

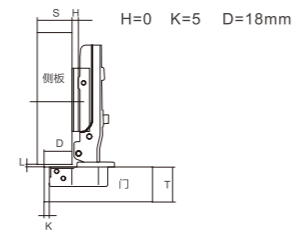

	3	4	5	6	7
0	17	18	19	20	21
2	15	16	17	18	19
4	13	14	15	16	17



直弯

(Full-overlay 全盖)

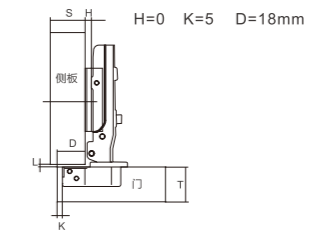

	3	4	5	6	7
0	17	18	19	20	21
2	15	16	17	18	19
4	13	14	15	16	17



中弯

(Half cover 半盖)

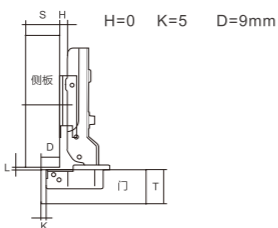

	3	4	5	6	7
0	8	9	10	11	12
2	6	7	8	9	10
4	4	5	6	7	8



中弯

(Half cover 半盖)

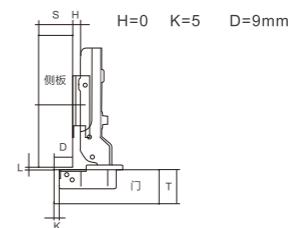

	3	4	5	6	7
0	8	9	10	11	12
2	6	7	8	9	10
4	4	5	6	7	8



大弯

(Inside 内侧)

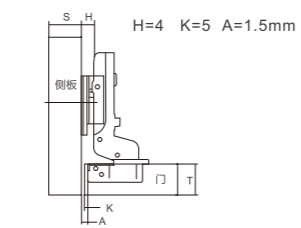

	3	4	5	6	7
0	1	0	-1	-2	-3
2	3	2	1	0	-1
4	5	4	3	2	1



大弯

(Inside 内侧)

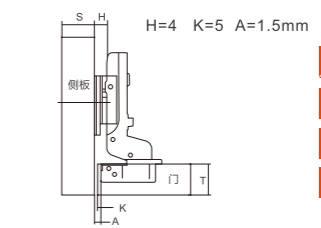

	3	4	5	6	7
0	1	0	-1	-2	-3
2	3	2	1	0	-1
4	5	4	3	2	1



**一段力不锈钢缓冲铰链**  
A stainless steel cushion hinge

产品信息  
Information

开启角度：105度  
Opening angle:105°

铰杯厚度：11.3毫米  
Depth of hinge cup:11.3mm

铰杯直径：35毫米  
Diameter of hinge cup:35mm

可选门板厚度：14-23毫米  
Range of door thickness:14-23mm

主要材质：不锈钢(201/304)  
Material: Stainless steel(201/304)

可配底座 (Plate) :

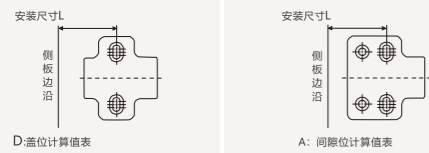

铰杯种类 (Hinge cup types)

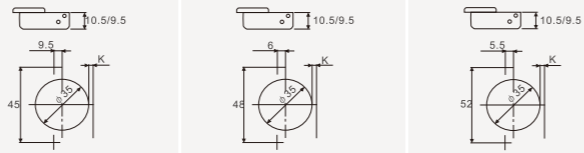

直弯

(Full-overlay 全盖)

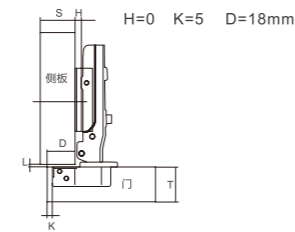

	3	4	5	6	7
0	17	18	19	20	21
2	15	16	17	18	19
4	13	14	15	16	17



**262 三维缓冲铰链**  
3 d buffer hinge

产品信息  
Information

开启角度：105度  
Opening angle:105°

铰杯厚度：11.3毫米  
Depth of hinge cup:11.3mm

铰杯直径：35毫米  
Diameter of hinge cup:35mm

可选门板厚度：16-25毫米  
Range of door thickness:16-25mm

主要材质：冷轧钢  
Material: Cold rolled steel

可配底座 (Plate) :

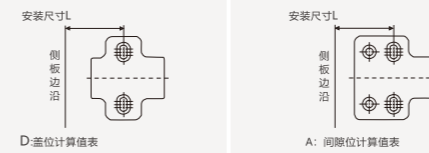

铰杯种类 (Hinge cup types)

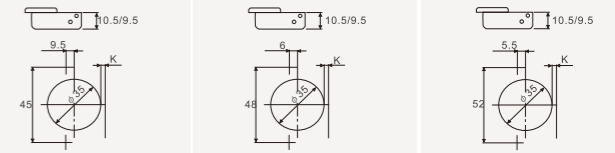

直弯

(Full-overlay 全盖)

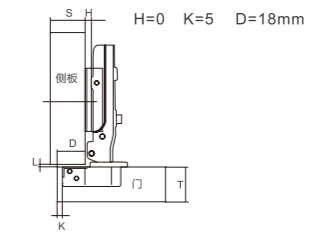

	3	4	5	6	7
0	17	18	19	20	21
2	15	16	17	18	19
4	13	14	15	16	17



中弯

(Half cover 半盖)

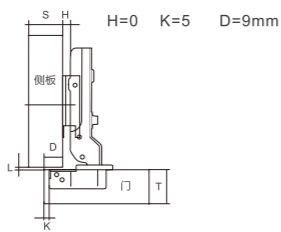

	3	4	5	6	7
0	8	9	10	11	12
2	6	7	8	9	10
4	4	5	6	7	8



中弯

(Half cover 半盖)

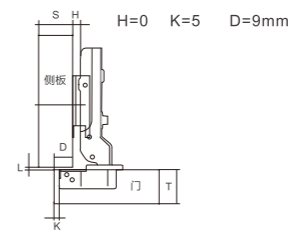

	3	4	5	6	7
0	8	9	10	11	12
2	6	7	8	9	10
4	4	5	6	7	8



大弯

(Inside 内侧)

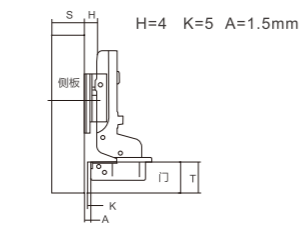

	3	4	5	6	7
0	1	0	-1	-2	-3
2	3	2	1	0	-1
4	5	4	3	2	1



大弯

(Inside 内侧)

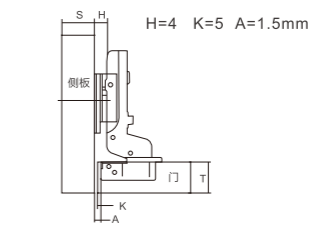

	3	4	5	6	7
0	1	0	-1	-2	-3
2	3	2	1	0	-1
4	5	4	3	2	1



**铝框缓冲铰链(镀铬)**  
The aluminum frame buffer hinge(Chrome plated)

产品信息  
Information

开启角度: 105度  
Opening angle: 105°

铰杯厚度: 11.3毫米  
Depth of hinge cup: 11.3mm

铰杯直径: 32毫米  
Diameter of hinge cup: 32mm

可选门板厚度: 14-23毫米  
Range of door thickness: 14-23mm

主要材质: 锌合金/冷轧钢  
Material: Zinc alloy/cold rolled steel

可配底座 (Plate):

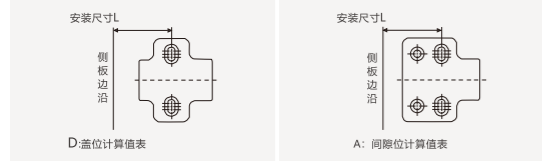

铰杯种类 (Hinge cup types)

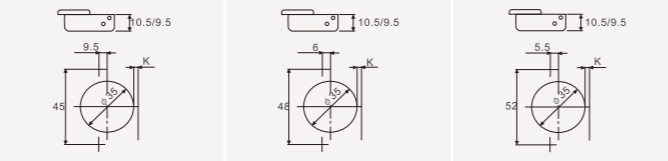

(Full-overlay 全盖)

H=0 K=5 D=18mm

$\frac{D}{H}$	3	4	5	6	7
0	17	18	19	20	21
2	15	16	17	18	19
4	13	14	15	16	17



(Half cover 半盖)

H=0 K=5 D=9mm

$\frac{D}{H}$	3	4	5	6	7
0	8	9	10	11	12
2	6	7	8	9	10
4	4	5	6	7	8



(Inside 内侧)

H=4 K=5 A=1.5mm

$\frac{D}{H}$	3	4	5	6	7
0	1	0	-1	-2	-3
2	3	2	1	0	-1
4	5	4	3	2	1



**铝框缓冲铰链(枪黑)**  
The aluminum frame buffer hinge(Gun black)

产品信息  
Information

开启角度: 105度  
Opening angle: 105°

铰杯厚度: 11.3毫米  
Depth of hinge cup: 11.3mm

铰杯直径: 32毫米  
Diameter of hinge cup: 32mm

可选门板厚度: 14-23毫米  
Range of door thickness: 14-23mm

主要材质: 锌合金/冷轧钢  
Material: Zinc alloy/cold rolled steel

可配底座 (Plate):

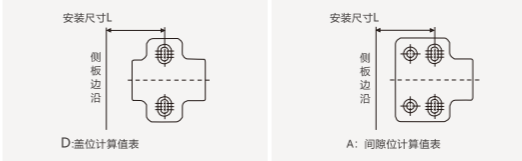

铰杯种类 (Hinge cup types)

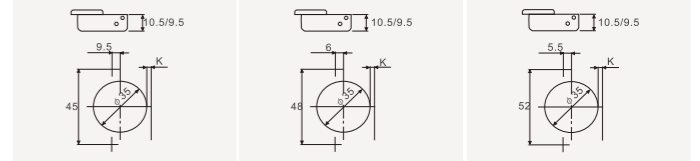

(Full-overlay 全盖)

H=0 K=5 D=18mm

$\frac{D}{H}$	3	4	5	6	7
0	17	18	19	20	21
2	15	16	17	18	19
4	13	14	15	16	17



(Half cover 半盖)

H=0 K=5 D=9mm

$\frac{D}{H}$	3	4	5	6	7
0	8	9	10	11	12
2	6	7	8	9	10
4	4	5	6	7	8



(Inside 内侧)

H=4 K=5 A=1.5mm

$\frac{D}{H}$	3	4	5	6	7
0	1	0	-1	-2	-3
2	3	2	1	0	-1
4	5	4	3	2	1



**35杯玻璃门缓冲铰链**  
35 cup glass door hinge buffer

产品信息  
Information

开启角度：105度  
Opening angle:105°

玻璃门厚度：8毫米/10毫米  
The thickness of the glass door:8mm/10mm

玻璃门直径：35毫米  
The glass door in diameter:35mm

可选门板厚度：14-23毫米  
Range of door thickness:14-23mm

主要材质：ABS塑料+冷轧钢  
Material: ABS plastic + cold rolled steel

可配底座 (Plate) :

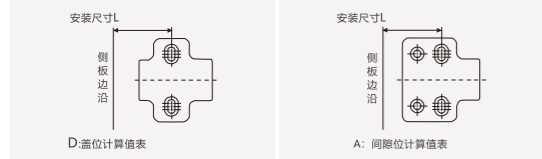

铰杯种类 (Hinge cup types)

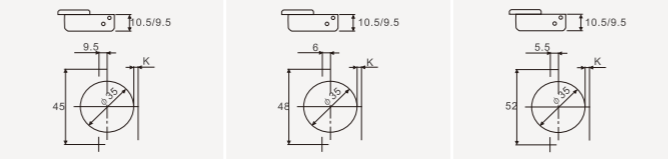

直弯

(Full-overlay 全盖)

H=0 K=5 D=18mm

$\frac{D}{H}$	3	4	5	6	7
0	17	18	19	20	21
2	15	16	17	18	19
4	13	14	15	16	17



**短臂缓冲铰链**  
Short arm cushion hinge

产品信息  
Information

开启角度：105度  
Opening angle:105°

铰杯厚度：11.3毫米  
Depth of hinge cup:11.3mm

铰杯直径：35毫米  
Diameter of hinge cup:35mm

可选门板厚度：14-23毫米  
Range of door thickness:14-23mm

主要材质：冷轧钢  
Material: Cold rolled steel

可配底座 (Plate) :

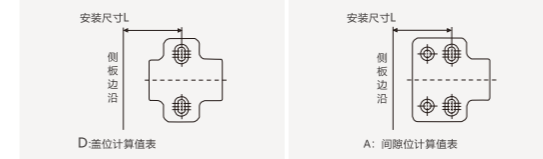

铰杯种类 (Hinge cup types)

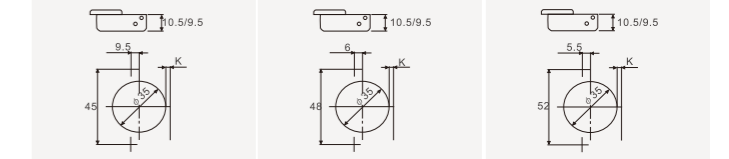

直弯

(Full-overlay 全盖)

H=0 K=5 D=18mm

$\frac{D}{H}$	3	4	5	6	7
0	17	18	19	20	21
2	15	16	17	18	19
4	13	14	15	16	17



中弯

(Half cover 半盖)

H=0 K=5 D=9mm

$\frac{D}{H}$	3	4	5	6	7
0	8	9	10	11	12
2	6	7	8	9	10
4	4	5	6	7	8



中弯

(Half cover 半盖)

H=0 K=5 D=9mm

$\frac{D}{H}$	3	4	5	6	7
0	8	9	10	11	12
2	6	7	8	9	10
4	4	5	6	7	8



大弯

(Inside 内侧)

H=4 K=5 A=1.5mm

$\frac{D}{H}$	3	4	5	6	7
0	1	0	-1	-2	-3
2	3	2	1	0	-1
4	5	4	3	2	1



大弯

(Inside 内侧)

H=4 K=5 A=1.5mm

$\frac{D}{H}$	3	4	5	6	7
0	1	0	-1	-2	-3
2	3	2	1	0	-1
4	5	4	3	2	1



**3寸/4寸/4寸缓冲弹子铰**  
3/4 inches / 4 inch buffer pool hinge

产品信息  
Information

开启角度: ----  
Opening angle: ----

铰杯厚度: ----  
Depth of hinge cup: ----

铰杯直径: ----  
Diameter of hinge cup: ----

可选门板厚度: ----  
Range of door thickness: ----

主要材质: 冷轧钢  
Material: Cold rolled steel

可配底座 (Plate):

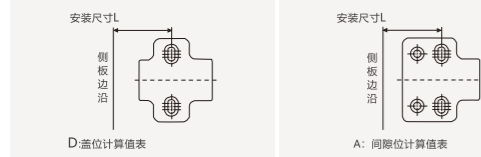

铰杯种类 (Hinge cup types)

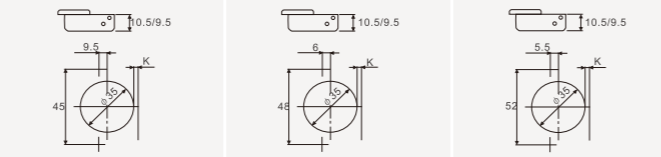

(Full-overlay 全盖)

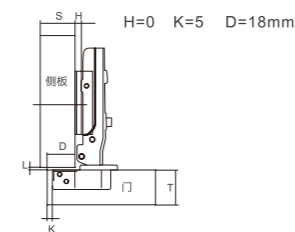

$\frac{D}{H} \times K$	3	4	5	6	7
0	17	18	19	20	21
2	15	16	17	18	19
4	13	14	15	16	17



**165°缓冲铰链**  
165° cushion hinge

产品信息  
Information

开启角度: 165度  
Opening angle: 165°

铰杯厚度: 11.3毫米  
Depth of hinge cup: 11.3mm

铰杯直径: 35毫米  
Diameter of hinge cup: 35mm

可选门板厚度: 20-35毫米  
Range of door thickness: 20-35mm

主要材质: 冷轧钢  
Material: Cold rolled steel

可配底座 (Plate):

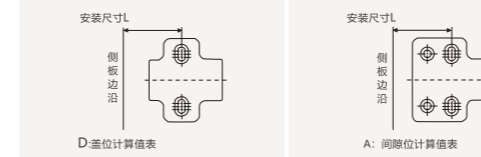

铰杯种类 (Hinge cup types)

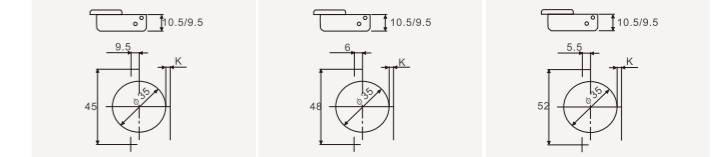

(Full-overlay 全盖)

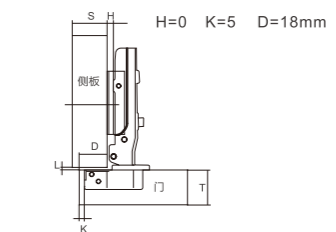

$\frac{D}{H} \times K$	3	4	5	6	7
0	17	18	19	20	21
2	15	16	17	18	19
4	13	14	15	16	17



(Half cover 半盖)

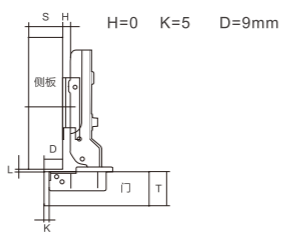

$\frac{D}{H} \times K$	3	4	5	6	7
0	8	9	10	11	12
2	6	7	8	9	10
4	4	5	6	7	8



(Half cover 半盖)

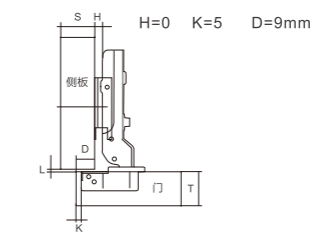

$\frac{D}{H} \times K$	3	4	5	6	7
0	8	9	10	11	12
2	6	7	8	9	10
4	4	5	6	7	8



(Inside 内侧)

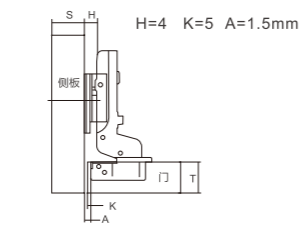

$\frac{D}{H} \times K$	3	4	5	6	7
0	1	0	-1	-2	-3
2	3	2	1	0	-1
4	5	4	3	2	1



(Inside 内侧)

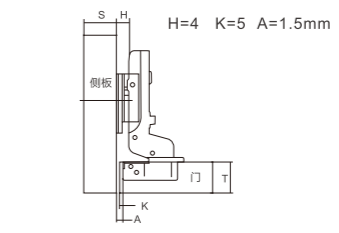

$\frac{D}{H} \times K$	3	4	5	6	7
0	1	0	-1	-2	-3
2	3	2	1	0	-1
4	5	4	3	2	1





**多角度铰链(缓冲/普通)**  
Multi-angle hinge (buffer/normal)

产品信息  
Information

开启角度：135/95/45/30度  
Opening angle:135/95/45/30°

铰杯厚度：11.3毫米  
Depth of hinge cup:11.3mm

铰杯直径：35毫米  
Diameter of hinge cup:35mm

可选门板厚度：14-23毫米  
Range of door thickness:14-23mm

主要材质：冷轧钢  
Material: Cold rolled steel

铰杯种类 (Hinge cup types)

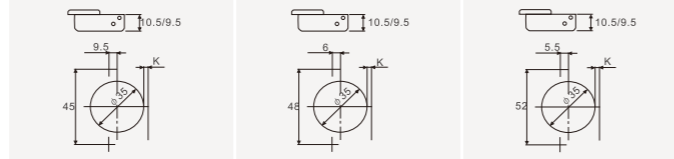

**多角度铰链**  
Multi-angle hinge

产品信息  
Information

开启角度：-30/-45/45度  
Opening angle:-30/-45/45°

铰杯厚度：11.3毫米  
Depth of hinge cup:11.3mm

铰杯直径：35毫米  
Diameter of hinge cup:35mm

可选门板厚度：14-23毫米  
Range of door thickness:14-23mm

主要材质：冷轧钢  
Material: Cold rolled steel

可配底座 (Plate) :

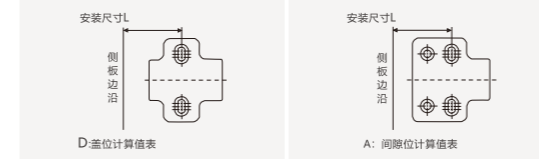

铰杯种类 (Hinge cup types)

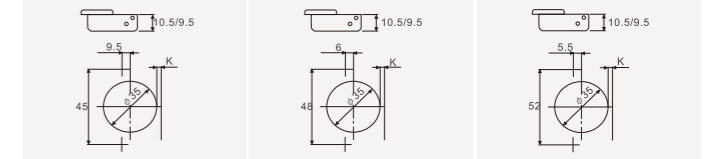

(Full-overlay 全盖)

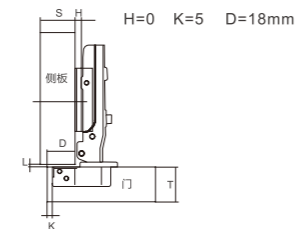

	3	4	5	6	7
0	17	18	19	20	21
2	15	16	17	18	19
4	13	14	15	16	17



(Full-overlay 全盖)

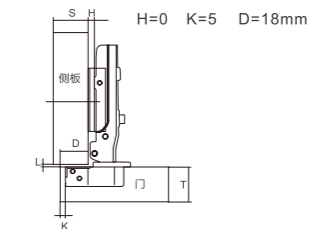

	3	4	5	6	7
0	17	18	19	20	21
2	15	16	17	18	19
4	13	14	15	16	17



(Half cover 半盖)

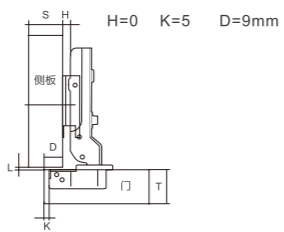

	3	4	5	6	7
0	8	9	10	11	12
2	6	7	8	9	10
4	4	5	6	7	8



(Half cover 半盖)

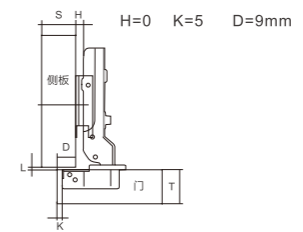

	3	4	5	6	7
0	8	9	10	11	12
2	6	7	8	9	10
4	4	5	6	7	8



(Inside 内侧)

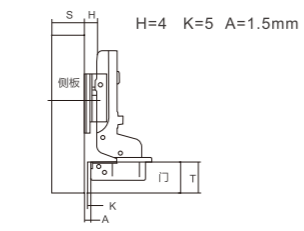

	3	4	5	6	7
0	1	0	-1	-2	-3
2	3	2	1	0	-1
4	5	4	3	2	1



(Inside 内侧)

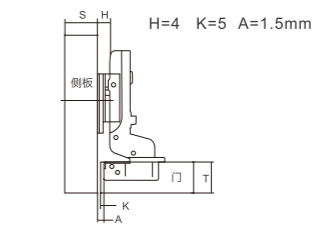

	3	4	5	6	7
0	1	0	-1	-2	-3
2	3	2	1	0	-1
4	5	4	3	2	1



**无弹力反弹铰链**  
No elastic rebound hinge

产品信息  
Information

开启角度：105度  
Opening angle:105°

铰杯厚度：11.3毫米  
Depth of hinge cup:11.3mm

铰杯直径：35毫米  
Diameter of hinge cup:35mm

可选门板厚度：14-23毫米  
Range of door thickness:14-23mm

主要材质：不锈钢(201/304)  
Material: Stainless steel(201/304)

铰链配套反弹器:



铰杯种类 (Hinge cup types)

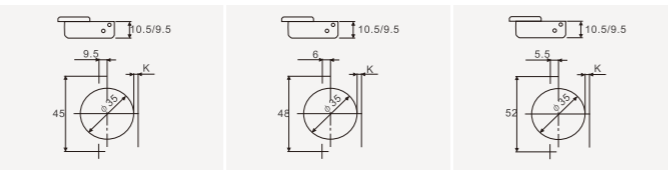

(Full-overlay 全盖)

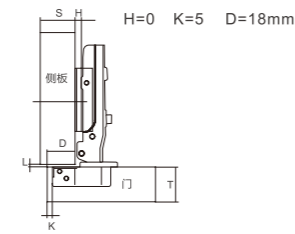

$\frac{D}{H}$	3	4	5	6	7
0	17	18	19	20	21
2	15	16	17	18	19
4	13	14	15	16	17

(Half cover 半盖)

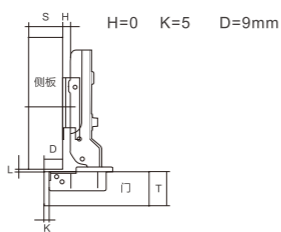

$\frac{D}{H}$	3	4	5	6	7
0	8	9	10	11	12
2	6	7	8	9	10
4	4	5	6	7	8

(Inside 内侧)

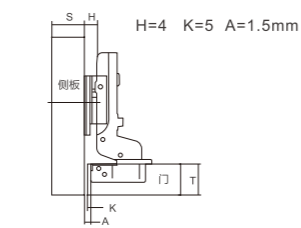

$\frac{D}{H}$	3	4	5	6	7
0	1	0	-1	-2	-3
2	3	2	1	0	-1
4	5	4	3	2	1

直弯

中弯

大弯



**左右铰链**  
About the hinge

产品信息  
Information

开启角度：105度  
Opening angle:105°

铰杯厚度：11.3毫米  
Depth of hinge cup:11.3mm

铰杯直径：35毫米  
Diameter of hinge cup:35mm

可选门板厚度：14-23毫米  
Range of door thickness:14-23mm

主要材质：不锈钢(201/304)  
Material: Stainless steel(201/304)



**铰链灯**  
Hinge lamp

产品信息  
Information

开启角度：----  
Opening angle:----

铰杯厚度：----  
Depth of hinge cup:----

铰杯直径：----  
Diameter of hinge cup:----

可选门板厚度：----  
Range of door thickness:----

主要材质：ABS塑料材质+LED灯光  
Material: Stainless steel(201/304)



经久耐用  
滑动顺畅  
平稳性强  
轨迹精确

Durable  
Smooth sliding  
Strong stability  
Precise trajectory

滑轨系列  
Slide series

滑轨系列  
SLIDE SERIES

钻石品质 服务一流 时尚外观

滑轨系列 Slide series

滑轨系列



041 阻尼骑马抽屜  
P041

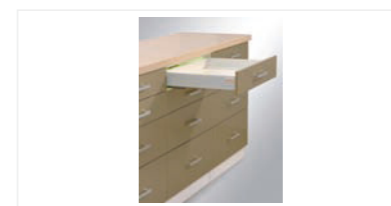

042 阻尼骑马抽屜  
P042

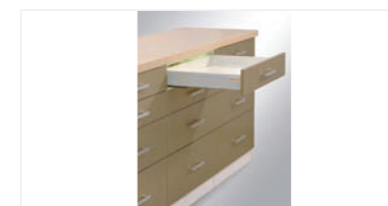

043 阻尼骑马抽屜  
P043



044 阻尼骑马抽屜  
P044

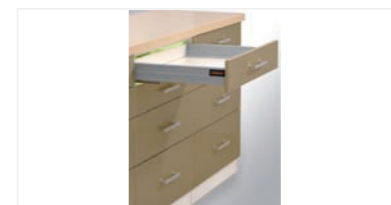

045 阻尼骑马抽屜  
P045



047 三节隐藏阻尼滑轨  
P047



048 三节隐藏反弹滑轨  
P048



049 二节隐藏反弹滑轨  
P049



050 二节隐藏缓冲滑轨  
P050



052 三节双缓冲阻尼滑轨  
P052



053 三节缓冲阻尼滑轨  
P053



054 三节反弹滑轨  
P054



055 缓冲+反弹一体阻尼滑轨  
P055



056 三节反弹滑轨  
P056



057 三节普通滑轨  
P057



058 三节普通滑轨  
P058



059 电视滑轨  
P059



060 天地阻尼滑轨  
P060

滑轨系列  
Slide series

041 阻尼骑马抽屉



042 阻尼骑马抽屉



安装孔尺寸(mm)

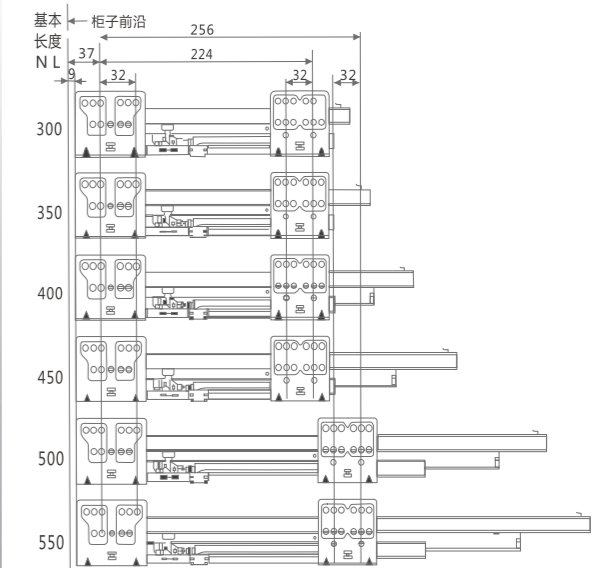

滑轨系列  
Slide series

滑轨系列  
Slide series



产品信息  
Information

主要材质：冷轧钢板  
Material: Cold-rolled Steel

表面处理：银灰色，白灰色  
Finish: Silver grey, white grey

安装方式：底装/螺丝固定  
Installation: Base mounted/ Screw fixing

产品描述：全拉伸（三节轨）/前板可拆卸  
Description: Full extension/ Detachable inner side / Removal of front panel

产品功能：静音效果，内置缓冲装置使抽屉关闭轻柔安静；钝化处理，更强防锈  
Features: Silent System. The integrated soft-closing mechanism lets drawer close gentle and quietly; Features: Silent System. The integrated soft-closing mechanism lets drawer close gentle and quietly;钝化处理，更强防锈



编号	宽度	厚度	抽屉长度	最大门重	包装方式
041-1	95.5mm	1.2×1.2×1.5mm	270-550mm	35kg	6套/箱
041-2	175.5mm	1.2×1.2×1.5mm	270-550mm	35kg	6套/箱
041-3	125.5mm	1.2×1.2×1.5mm	270-550mm	35kg	6套/箱
041-4	201.5mm	1.2×1.2×1.5mm	270-550mm	35kg	6套/箱



类型	尺寸	最小橱柜长度	抽屉高度
P300	300mm	320mm	83mm
P350	350mm	370mm	83mm
P400	400mm	420mm	83mm
P450	450mm	470mm	83mm
P500	500mm	520mm	83mm
P550	550mm	570mm	142mm
G300	300mm	320mm	142mm
G350	350mm	370mm	142mm
G400	400mm	420mm	142mm
G450	450mm	470mm	142mm
G500	500mm	520mm	142mm
G550	550mm	570mm	142mm

043 阻尼骑马抽屉



安装孔尺寸(mm)

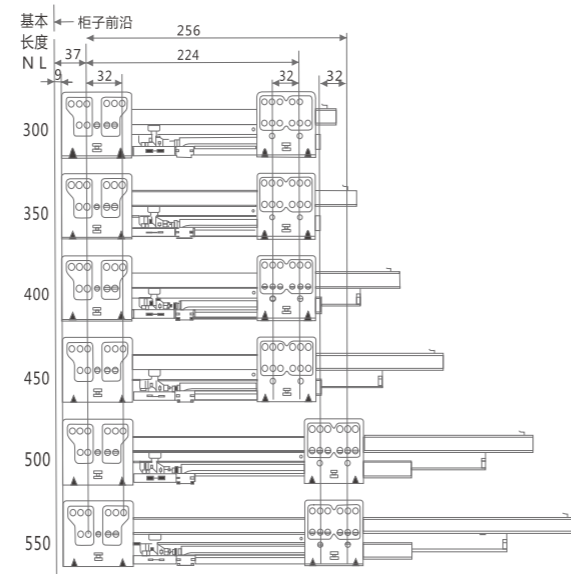

类型	尺寸	最小橱柜长度	抽屉高度
P300	300mm	320mm	83mm
P350	350mm	370mm	83mm
P400	400mm	420mm	83mm
P450	450mm	470mm	83mm
P500	500mm	520mm	83mm
P550	550mm	570mm	142mm
G300	300mm	320mm	142mm
G350	350mm	370mm	142mm
G400	400mm	420mm	142mm
G450	450mm	470mm	142mm
G500	500mm	520mm	142mm
G550	550mm	570mm	142mm

044 阻尼骑马抽屉



安装孔尺寸(mm)

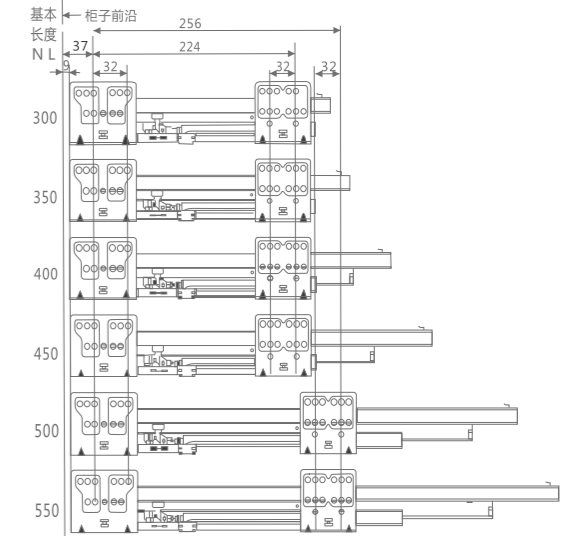

类型	尺寸	最小橱柜长度	抽屉高度
P300	300mm	320mm	83mm
P350	350mm	370mm	83mm
P400	400mm	420mm	83mm
P450	450mm	470mm	83mm
P500	500mm	520mm	83mm
P550	550mm	570mm	142mm
G300	300mm	320mm	142mm
G350	350mm	370mm	142mm
G400	400mm	420mm	142mm
G450	450mm	470mm	142mm
G500	500mm	520mm	142mm
G550	550mm	570mm	142mm

045 阻尼骑马抽屉



安装孔尺寸(mm)

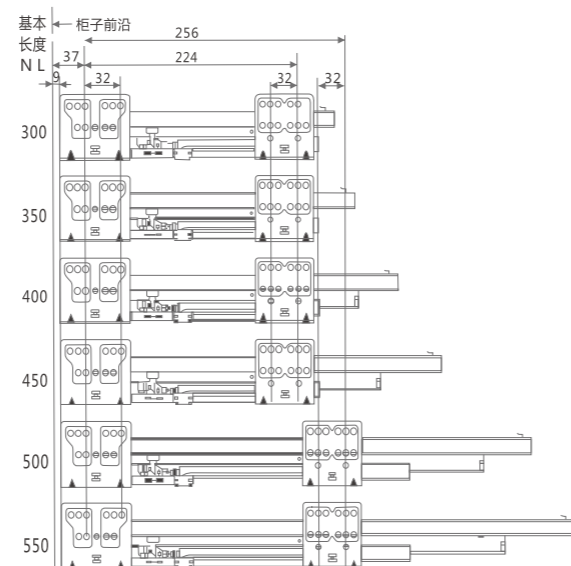

类型	尺寸	最小橱柜长度	抽屉高度
P300	300mm	320mm	83mm
P350	350mm	370mm	83mm
P400	400mm	420mm	83mm
P450	450mm	470mm	83mm
P500	500mm	520mm	83mm
P550	550mm	570mm	142mm
G300	300mm	320mm	142mm
G350	350mm	370mm	142mm
G400	400mm	420mm	142mm
G450	450mm	470mm	142mm
G500	500mm	520mm	142mm
G550	550mm	570mm	142mm

经久耐用，静音顺滑  
采用镀锌带钢材质，  
大大减少外加带来的冲击力，  
来达到静音的效果。

Durable, quiet and smooth  
Made of galvanized steel strip.  
Greatly reduce the impact of the impact,  
To achieve the mute effect.



047 三节隐藏阻尼滑轨



产品信息  
Information

主要材质：冷轧钢板  
Material: Cold-rolled Steel

表面处理：镀锌  
Finish: Zinc Plate

安装方式：底装/螺丝固定  
Installation: Base mounted/ Screw fixing

产品描述：全拉伸（三节轨）/抽屉与滑轨可拆卸/抽屉高度可调节+4.5mm  
Description: Full extension / Detachable drawer / Drawer height could be adjusted +4.5mm

产品功能：静音效果，内置缓冲装置使抽屉关闭轻柔安静；钝化处理，更强防锈  
Features: Silent System. The integrated soft-closing mechanism lets drawer close gentle and quietly; Galvanized passivation for better anti-rust ability

宽度	厚度	最大门重	抽屉长度
----	1.5mm	30kg	300-500mm

应用 Application

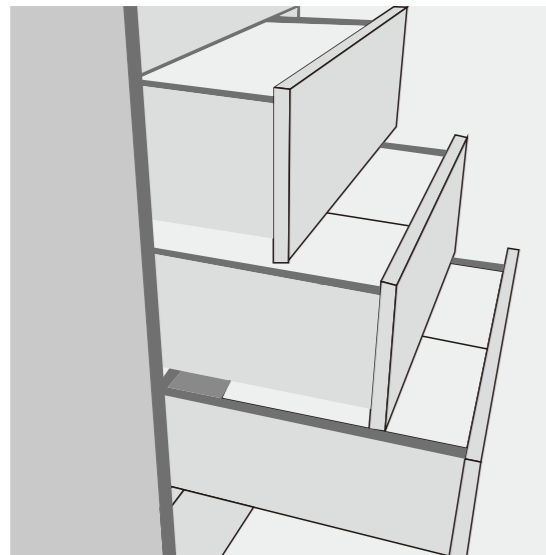

安装说明 Installation Notes

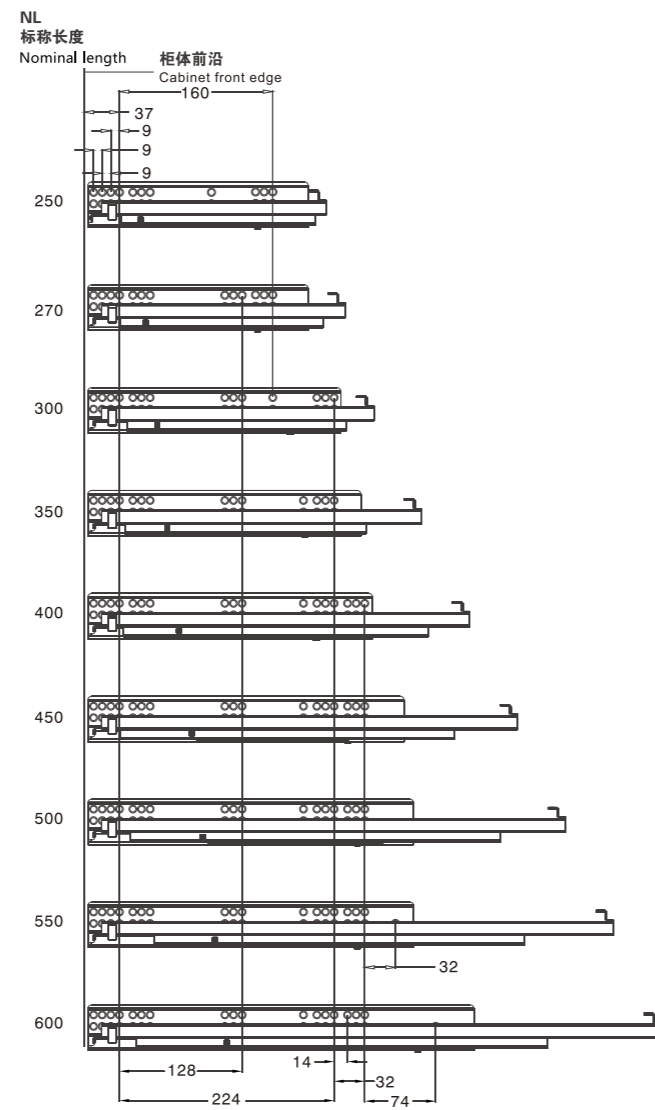

048 三节隐藏反弹滑轨



产品信息  
Information

主要材质：冷轧钢板  
Material: Cold-rolled Steel

表面处理：镀锌  
Finish: Zinc Plate

安装方式：底装/螺丝固定  
Installation: Base mounted/ Screw fixing

产品描述：全拉伸（三节轨）/抽屉与滑轨可拆卸/抽屉高度可调节+4.5mm  
Description: Full extension / Detachable drawer / Drawer height could be adjusted +4.5mm

产品功能：静音效果，内置缓冲装置使抽屉关闭轻柔安静；钝化处理，更强防锈  
Features: Silent System. The integrated soft-closing mechanism lets drawer close gentle and quietly; Galvanized passivation for better anti-rust ability

宽度	厚度	最大门重	抽屉长度
----	1.5mm	30kg	300-500mm

应用 Application

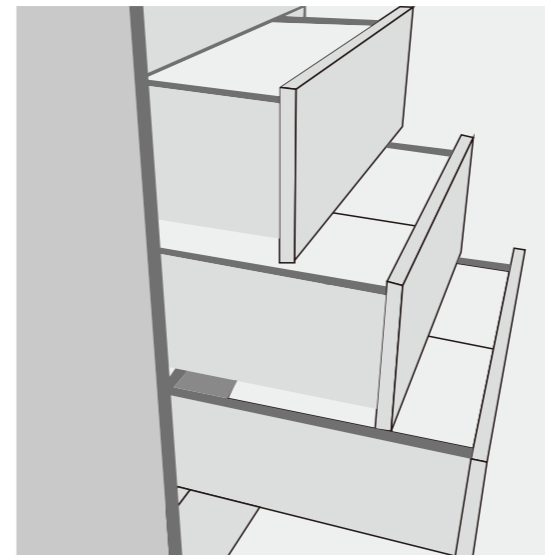

安装说明 Installation Notes

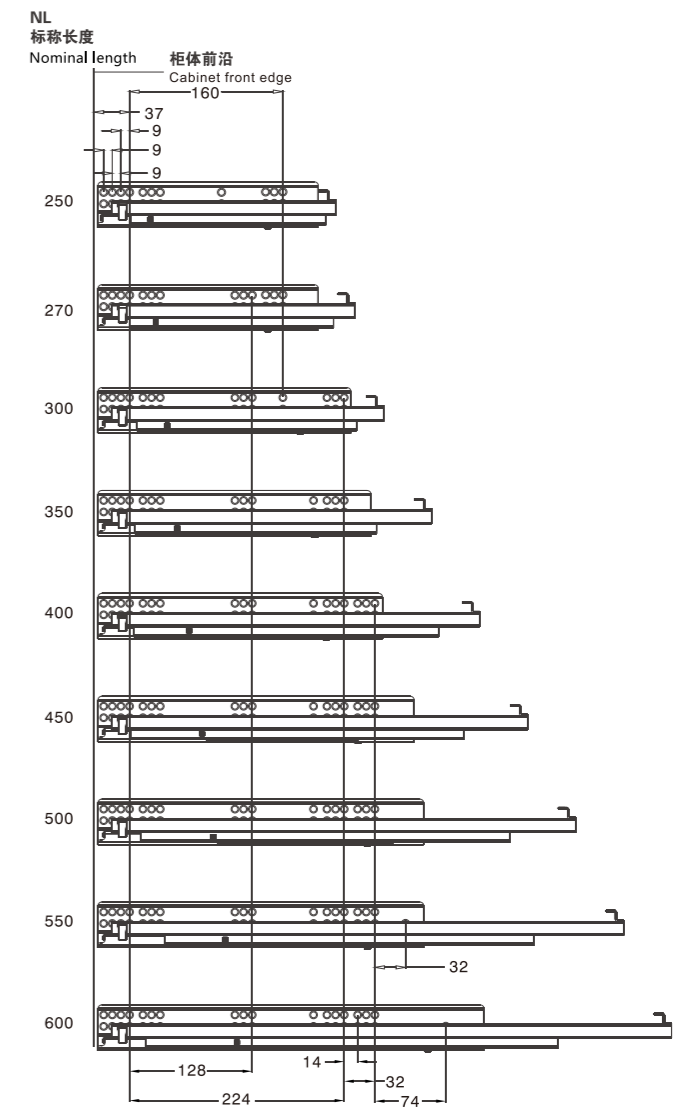

049 二节隐藏反弹滑轨



产品信息  
Information

主要材质：冷轧钢板  
Material: Cold-rolled Steel

表面处理：镀锌  
Finish: Zinc Plate

安装方式：底装/螺丝固定  
Installation: Base mounted/ Screw fixing

产品描述：全拉伸（二节轨）/抽屉与滑轨可拆卸/抽屉高度可调节+4.5mm  
Description: Full extension / Detachable drawer / Drawer height could be adjusted +4.5mm

产品功能：静音效果，内置缓冲装置使抽屉关闭轻柔安静；钝化处理，更强防锈  
Features: Silent System. The integrated soft-closing mechanism lets drawer close gentle and quietly; Galvanized passivation for better anti-rust ability

宽度	厚度	最大门重	抽屉长度
----	1.5mm	30kg	300-500mm

应用 Application

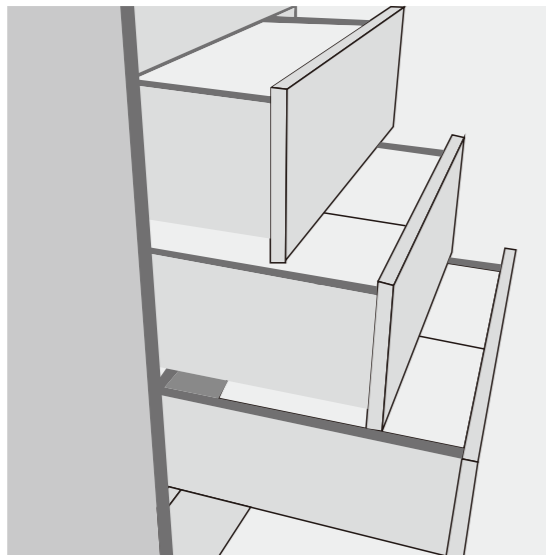

安装说明 Installation Notes

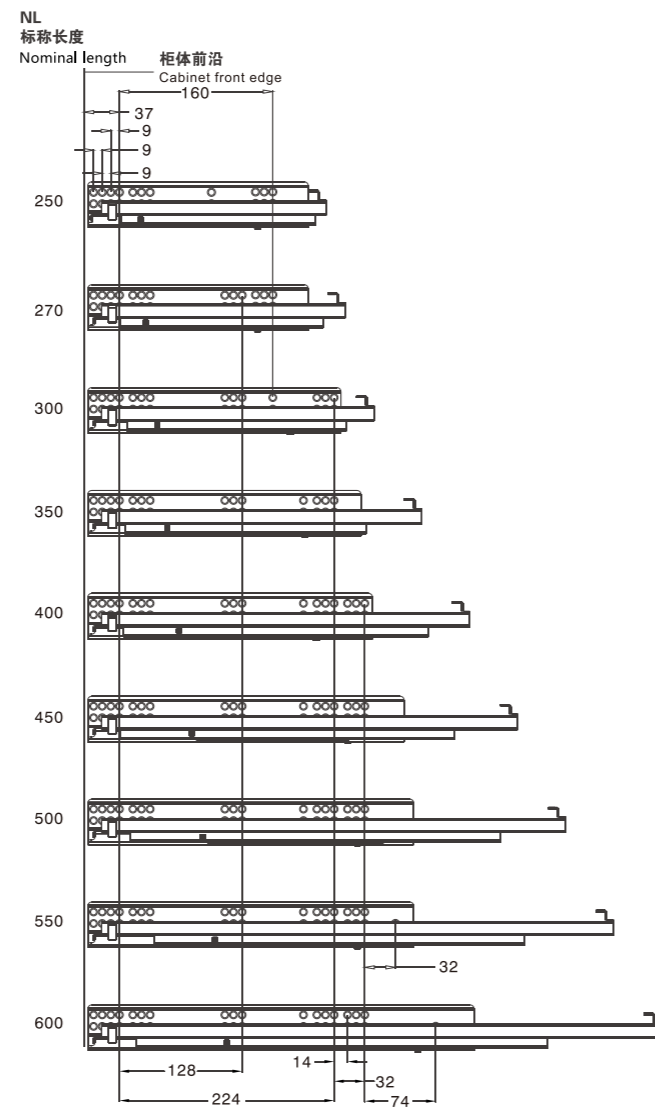

050 二节隐藏缓冲滑轨



产品信息  
Information

主要材质：冷轧钢板  
Material: Cold-rolled Steel

表面处理：镀锌  
Finish: Zinc Plate

安装方式：底装/螺丝固定  
Installation: Base mounted/ Screw fixing

产品描述：全拉伸（二节轨）/抽屉与滑轨可拆卸/抽屉高度可调节+4.5mm  
Description: Full extension / Detachable drawer / Drawer height could be adjusted +4.5mm

产品功能：静音效果，内置缓冲装置使抽屉关闭轻柔安静；钝化处理，更强防锈  
Features: Silent System. The integrated soft-closing mechanism lets drawer close gentle and quietly; Galvanized passivation for better anti-rust ability

宽度	厚度	最大门重	抽屉长度
----	1.5mm	30kg	300-500mm

应用 Application

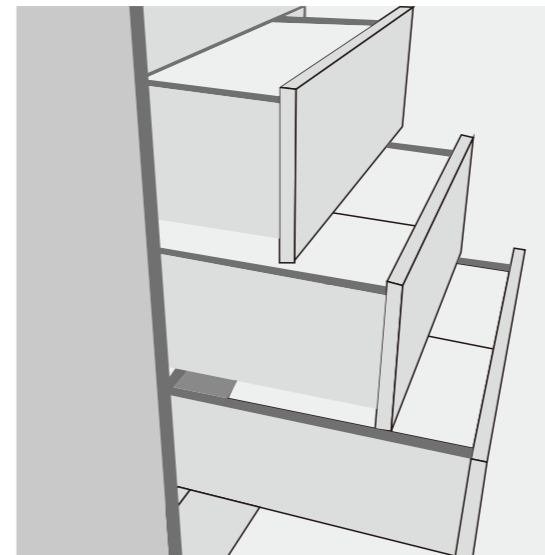

安装说明 Installation Notes

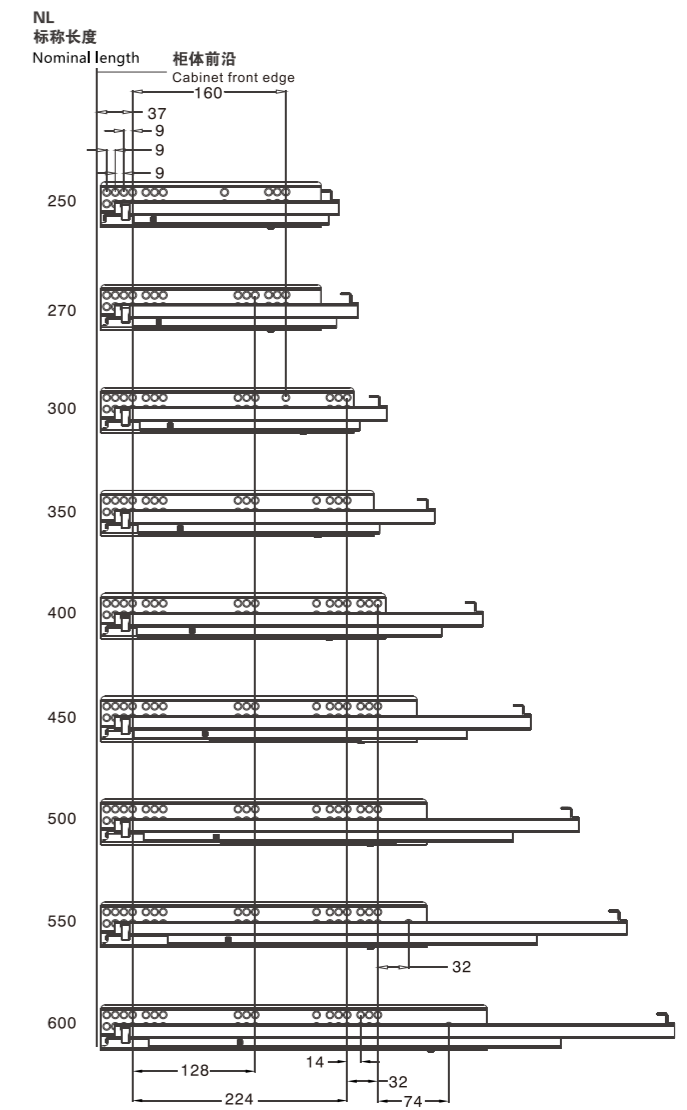



052 三节双缓冲阻尼滑轨



产品信息 Information

滑轨宽度 : 45mm  
Slide width: 45mm

载重 : 45Kg  
Dynamic load capacity: 45Kg

表面处理 : 电泳、电镀  
Finish: electrophoresis, plating

材料 : 冷轧钢板  
Material: cold rolled steel

材料厚度(内、中、外轨) : 1.0×1.0×1.2mm  
Thickness of material(I/M/O)part:1.0×1.0×1.2mm

滑轨安装尺寸 Installation size

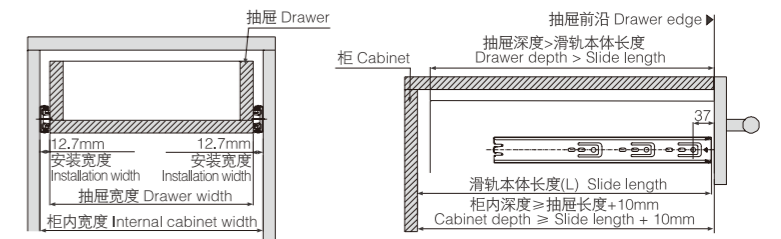

滑轨截面图 Profile

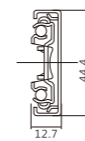

滑轨安装孔尺寸 Hole pattern

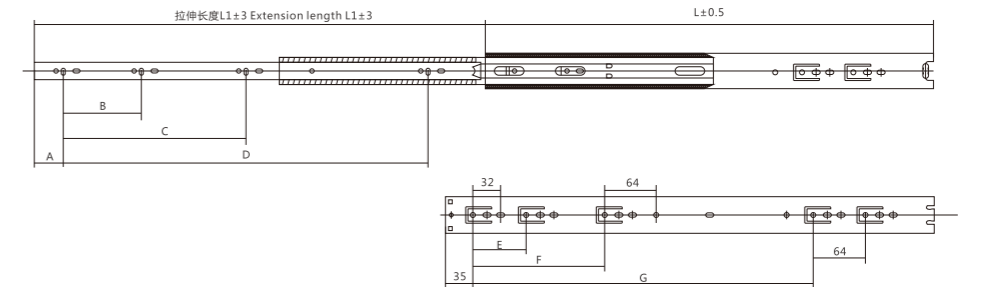

产品数据 Product data

Item No.	Length	A	B	C	D	E	F	G	L	L1
H4510-250	250	36	169			64		140	250	250
H4510-300	300	36	96	224		64		190	300	300
H4510-350	350	36	128	256		64		192	350	350
H4510-400	400	36	128	320		64		224	400	400
H4510-450	450	36	160	352		64		288	450	450
H4510-500	500	36	192	416		64		320	500	500
H4510-550	550	36	224	448		64		352	550	550
H4510-600	600	36	192	512		64		416	600	600
H4510-650	650	36	192	416	576	64	270	494	650	650
H4510-700	700	36	192	448	608	64	320	544	700	700

备注 : 最短 : 100mm(4寸) 150mm(6寸) 200mm(8寸)现货 最长 : 750mm(30寸) 800mm(32寸) 850mm(34寸) 900mm(36寸) 950mm(38寸) 1000mm(40寸)现货 可定做任意尺寸

德国工艺标准  
采用国外先进技术  
承载力强  
加厚材质  
经久耐用

German Craft Standard  
Using advanced foreign technology  
Strong bearing capacity  
Thickened material  
Durable

053 三节缓冲阻尼滑轨



产品信息 Information

滑轨宽度 : 45mm  
Slide width: 45mm

载重 : 25Kg  
Dynamic load capacity: 25Kg

表面处理 : 电泳、电镀  
Finish: electrophoresis, plating

材料 : 冷轧钢板  
Material: cold rolled steel

材料厚度(内、中、外轨) : 1.2×1.2×1.5mm  
Thickness of material(I/M/O)part: 1.2×1.2×1.5mm

滑轨安装尺寸 Installation size

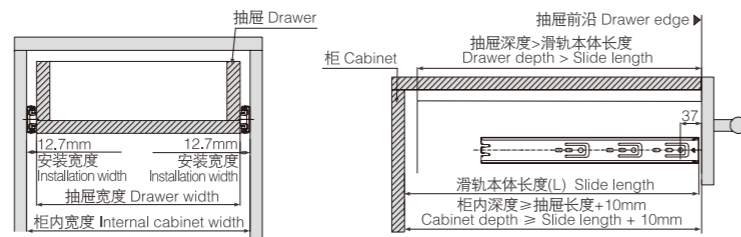

054 三节反弹滑轨



产品信息 Information

滑轨宽度 : 45mm  
Slide width: 45mm

载重 : 35Kg  
Dynamic load capacity: 35Kg

表面处理 : 电泳、电镀  
Finish: electrophoresis, plating

材料 : 冷轧钢板  
Material: cold rolled steel

材料厚度(内、中、外轨) : 1.0×1.0×1.2mm  
Thickness of material(I/M/O)part: 1.0×1.0×1.2mm

滑轨安装尺寸 Installation size

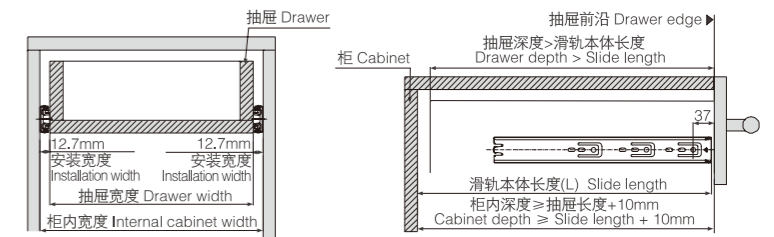

滑轨截面图 Profile

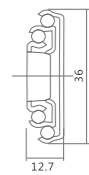

滑轨安装孔尺寸 Hole pattern

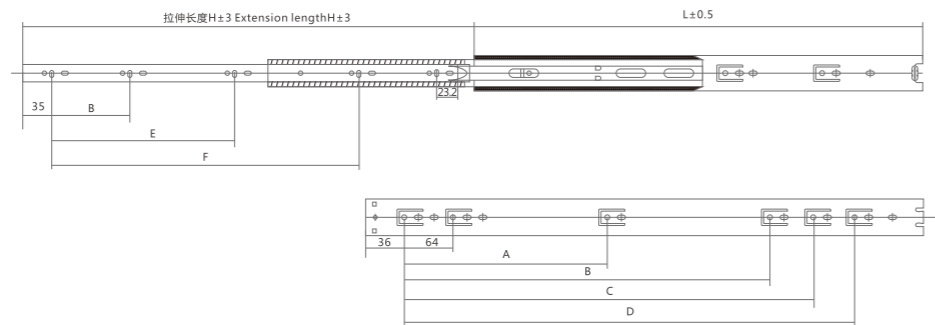

滑轨截面图 Profile

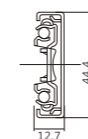

滑轨安装孔尺寸 Hole pattern

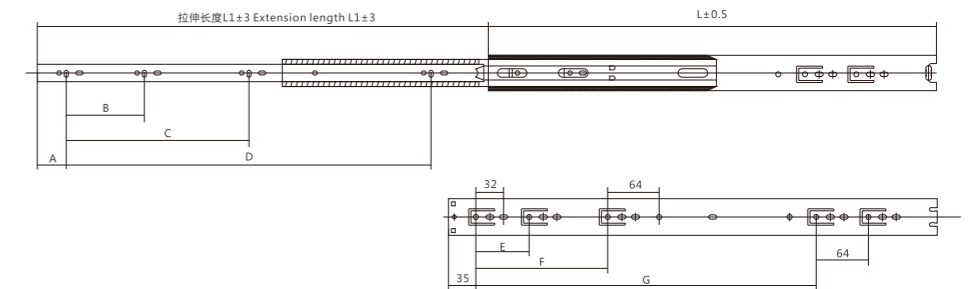

产品数据 Product data

Item No.	Length	A	B	C	D	E	F	G	L	H
H4512-250	250	128				64			250	271
H4512-300	300	128	224			128			300	307
H4512-350	350	128	224			128			350	369
H4512-400	400	128	224	320		128			400	420
H4512-450	450	128	224	352		128	320		450	467
H4512-500	500	128	224	352	416	128	192	352	500	518
H4512-550	550	128	224	352	448	128	192	384	550	544
H4512-600	600	128	224	352	480	128	192	416	600	623

备注 : 最短 : 100mm(4寸) 125mm(5寸) 150mm(6寸) 200mm(8寸)

产品数据 Product data

Item No.	Length	A	B	C	D	E	F	G	L	L1
H4510-250	250	36	169			64		140	250	250
H4510-300	300	36	96	224		64		190	300	300
H4510-350	350	36	128	256		64		192	350	350
H4510-400	400	36	128	320		64		224	400	400
H4510-450	450	36	160	352		64		288	450	450
H4510-500	500	36	192	416		64		320	500	500
H4510-550	550	36	224	448		64		352	550	550
H4510-600	600	36	192	512		64		416	600	600
H4510-650	650	36	192	416	576	64	270	494	650	650
H4510-700	700	36	192	448	608	64	320	544	700	700

备注 : 最短 : 100mm(4寸) 150mm(6寸) 200mm(8寸) 现货 最长 : 750mm(30寸) 800mm(32寸) 850mm(34寸) 900mm(36寸) 950mm(38寸) 1000mm(40寸) 现货 可定做任意尺寸

055 缓冲+反弹一体阻尼滑轨



产品信息 Information

滑轨宽度 : 45mm  
Slide width: 45mm

载重 : 35Kg  
Dynamic load capacity: 35Kg

表面处理 : 电泳、电镀  
Finish: electrophoresis, plating

材料 : 冷轧钢板  
Material: cold rolled steel

材料厚度(内、中、外轨) : 1.0×1.0×1.2mm  
Thickness of material(I/M/O)part:1.0×1.0×1.2mm

滑轨安装尺寸 Installation size

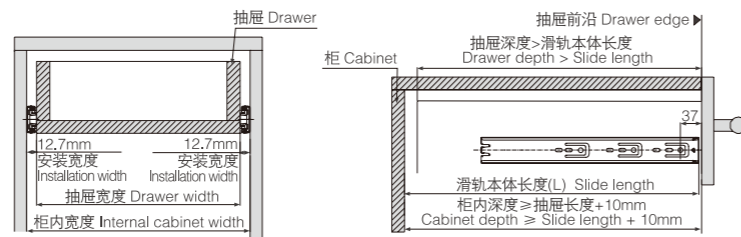

056 三节反弹滑轨



产品信息 Information

滑轨宽度 : 45mm  
Slide width: 45mm

载重 : 35Kg  
Dynamic load capacity: 35Kg

表面处理 : 电泳、电镀  
Finish: electrophoresis, plating

材料 : 冷轧钢板  
Material: cold rolled steel

材料厚度(内、中、外轨) : 1.2×1.2×1.5mm  
Thickness of material(I/M/O)part:1.2×1.2×1.5mm

滑轨安装尺寸 Installation size

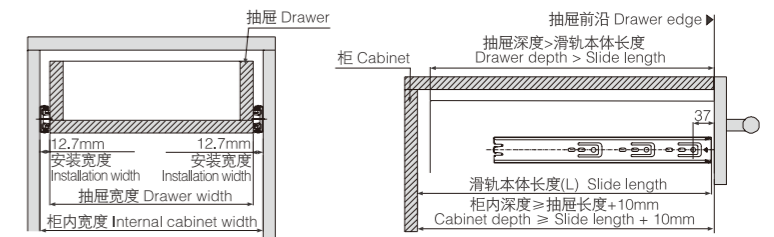

滑轨截面图 Profile

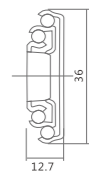

滑轨安装孔尺寸 Hole pattern

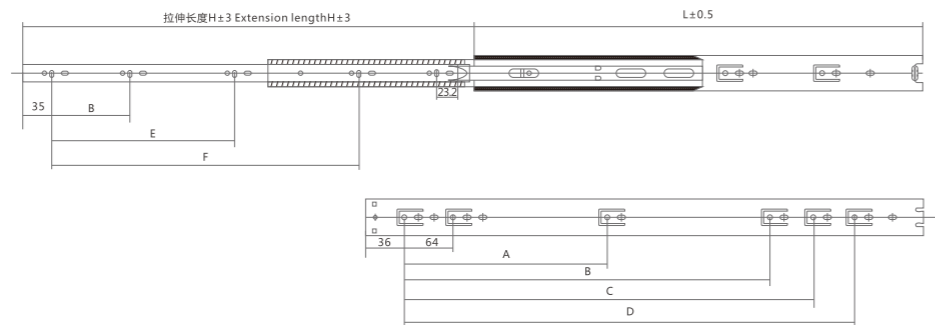

滑轨截面图 Profile

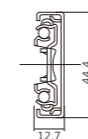

滑轨安装孔尺寸 Hole pattern

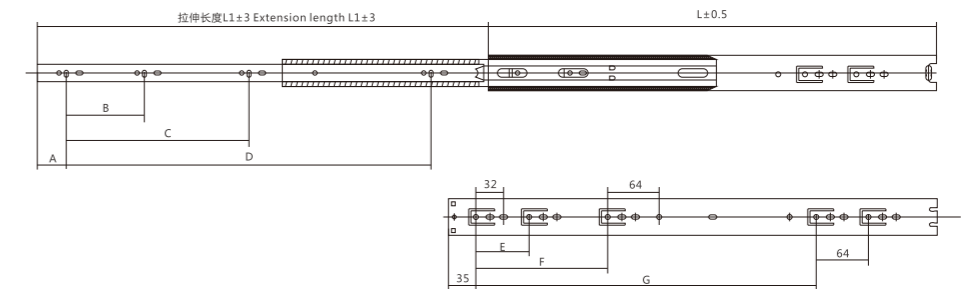

产品数据 Product data

Item No.	Length	A	B	C	D	E	F	G	L	H
H4510-250	250	128				64			250	271
H4510-300	300	128	224			128			300	307
H4510-350	350	128	224			128			350	369
H4510-400	400	128	224	320		128			400	420
H4510-450	450	128	224	352		128	320		450	467
H4510-500	500	128	224	352	416	128	192	352	500	518
H4510-550	550	128	224	352	448	128	192	384	550	544
H4510-600	600	128	224	352	480	128	192	416	600	623

备注 : 最短 : 100mm(4寸) 125mm(5寸) 150mm(6寸) 200mm(8寸)

产品数据 Product data

Item No.	Length	A	B	C	D	E	F	G	L	L1
H4512-250	250	36	169			64		140	250	250
H4512-300	300	36	96	224		64		190	300	300
H4512-350	350	36	128	256		64		192	350	350
H4512-400	400	36	128	320		64		224	400	400
H4512-450	450	36	160	352		64		288	450	450
H4512-500	500	36	192	416		64		320	500	500
H4512-550	550	36	224	448		64		352	550	550
H4512-600	600	36	192	512		64		416	600	600
H4512-650	650	36	192	416	576	64	270	494	650	650
H4512-700	700	36	192	448	608	64	320	544	700	700

备注 : 最短 : 100mm(4寸) 150mm(6寸) 200mm(8寸) 现货 最长 : 750mm(30寸) 800mm(32寸) 850mm(34寸) 900mm(36寸) 950mm(38寸) 1000mm(40寸) 现货 可定做任意尺寸

057 三节普通滑轨



产品信息 Information

滑轨宽度 : 30/35/40/45mm  
Slide width: 30/35/40/45mm

载重 : 25Kg  
Dynamic load capacity: 25Kg

表面处理 : 电泳、电镀  
Finish: electrophoresis, plating

材料 : 冷轧钢板  
Material: cold rolled steel

材料厚度(内、中、外轨) : 0.9×0.9×0.9mm  
Thickness of material(I/M/O)part:0.9×0.9×0.9mm

滑轨安装尺寸 Installation size

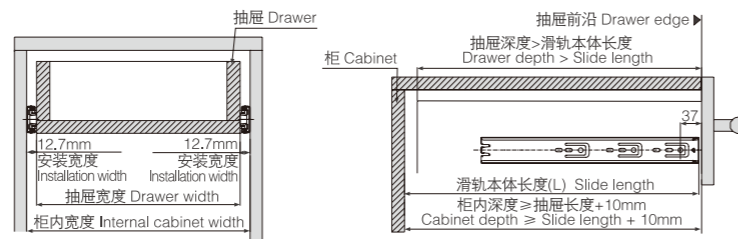

058 三节普通滑轨



产品信息 Information

滑轨宽度 : 30/35/40/45mm  
Slide width: 30/35/40/45mm

载重 : 25Kg  
Dynamic load capacity: 25Kg

表面处理 : 电泳、电镀  
Finish: electrophoresis, plating

材料 : 冷轧钢板  
Material: cold rolled steel

材料厚度(内、中、外轨) : 0.9×0.9×0.9mm  
Thickness of material(I/M/O)part:0.9×0.9×0.9mm

滑轨安装尺寸 Installation size

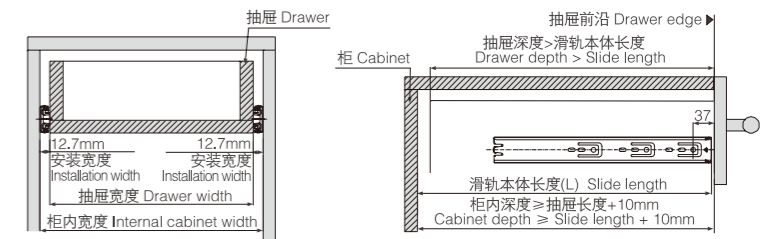

滑轨截面图 Profile

滑轨安装孔尺寸 Hole pattern

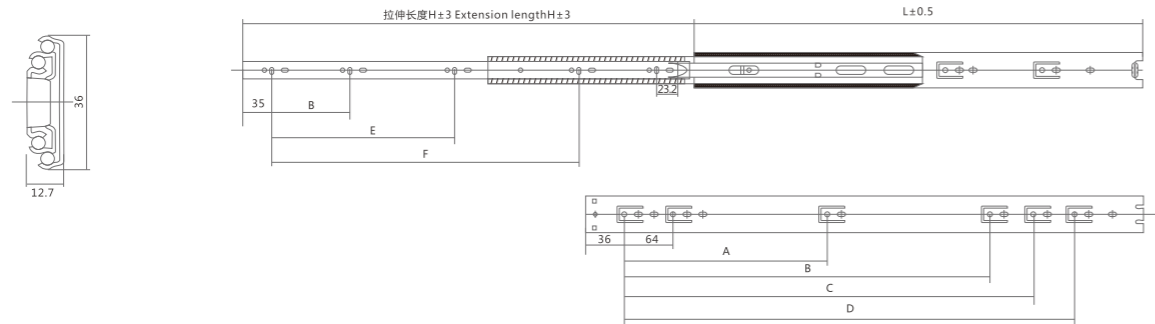

产品数据 Product data

Item No.	Length	A	B	C	D	E	F	G	L	H
H3601-250	250	128				64			250	271
H3601-300	300	128	224			128			300	307
H3601-350	350	128	224			128			350	369
H3601-400	400	128	224	320		128			400	420
H3601-450	450	128	224	352		128	320		450	467
H3601-500	500	128	224	352	416	128	192	352	500	518
H3601-550	550	128	224	352	448	128	192	384	550	544
H3601-600	600	128	224	352	480	128	192	416	600	623

备注 : 最短 : 100mm(4寸) 125mm(5寸) 150mm(6寸) 200mm(8寸)

滑轨截面图 Profile

滑轨安装孔尺寸 Hole pattern

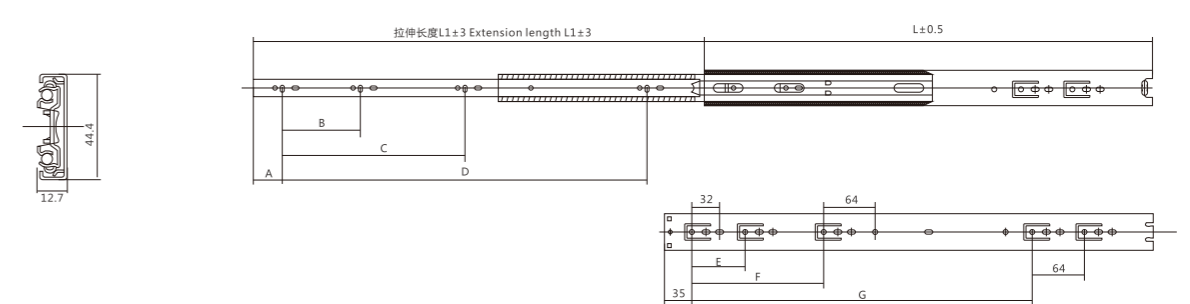

产品数据 Product data

Item No.	Length	A	B	C	D	E	F	G	L	L1
H4510-250	250	36	169			64		140	250	250
H4510-300	300	36	96	224		64		190	300	300
H4510-350	350	36	128	256		64		192	350	350
H4510-400	400	36	128	320		64		224	400	400
H4510-450	450	36	160	352		64		288	450	450
H4510-500	500	36	192	416		64		320	500	500
H4510-550	550	36	224	448		64		352	550	550
H4510-600	600	36	192	512		64		416	600	600
H4510-650	650	36	192	416	576	64	270	494	650	650
H4510-700	700	36	192	448	608	64	320	544	700	700

备注 : 最短 : 100mm(4寸) 150mm(6寸) 200mm(8寸) 现货 最长 : 750mm(30寸) 800mm(32寸) 850mm(34寸) 900mm(36寸) 950mm(38寸) 1000mm(40寸) 现货 可定做任意尺寸

059 电视滑轨

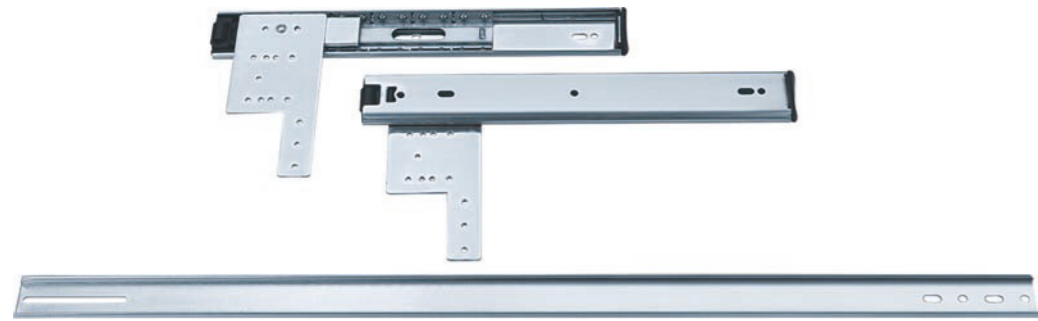

产品信息 Information

材料：冷轧钢板  
Material: cold rolled steel

载重：15k个 (18")  
Dynamic load capacity: 15kg(18")

表面处理：镀锌  
Finish: Plating lanxin

材料厚度(内、中、外轨)：1.4×1.5mm  
Thickness of material(I/O)part: 1.4×1.5mm

特点：是一种可以用隐藏式铰链锁紧门设计,带金属连杆作定位  
Features: designed for european concealed hinges allows for tight door-to-followerstrip. Deten-out

应用：隐藏门、壁柜、办公室抽屉,文件及储物柜,适用于横向和纵向  
Application: concealed door, wall unit, office cabinets, filing and storage systems. Can be installed horizontally vertically.

滑轨安装尺寸 Installation size

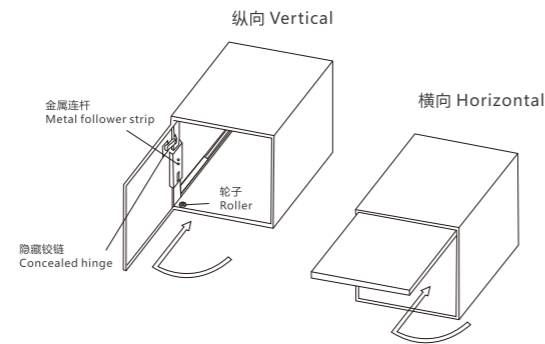

滑轨截面图 Profile

滑轨安装孔尺寸 Hole pattern

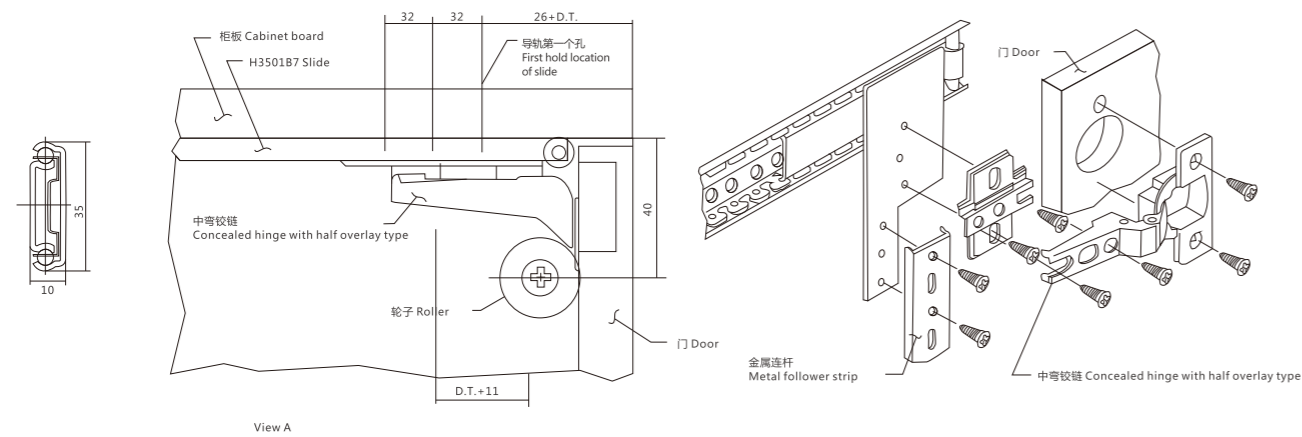

060 天地阻尼滑轨

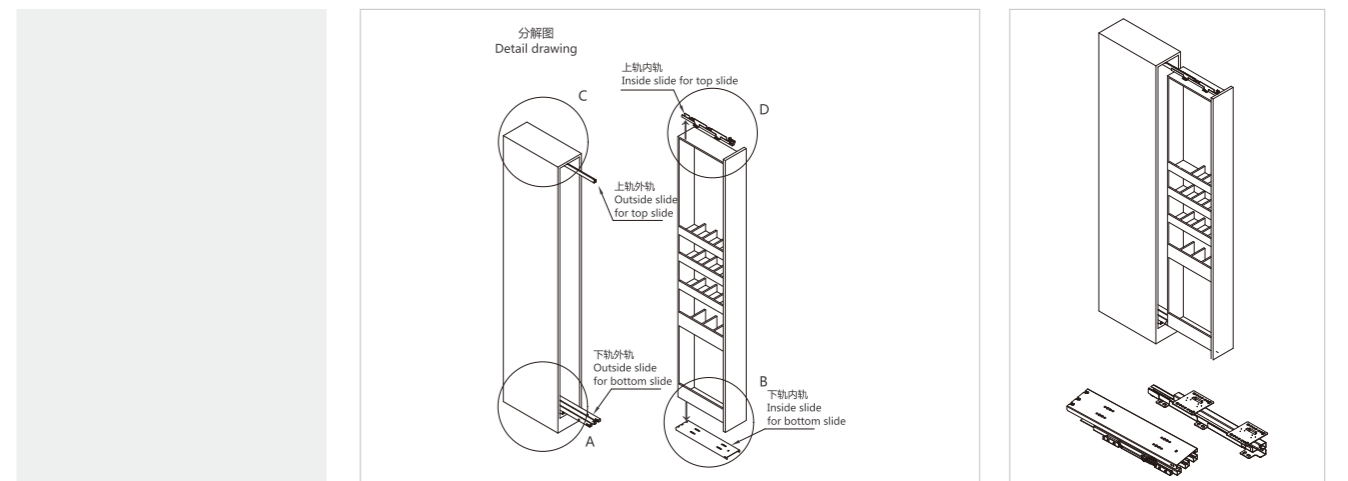
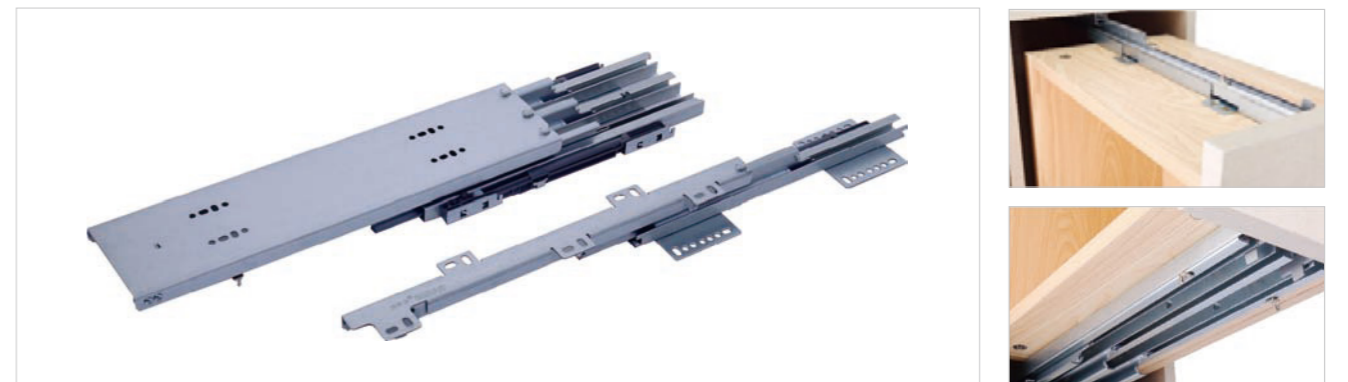

加粗行程杆  
实心设计  
不易生锈  
支撑更有力

Bold stroke lever  
Solid design  
Not easy to rust  
Stronger support

翻门配件系列  
Flap door fitting series



翻门配件系列  
FLAP DOOR FITTING SERIES



翻门配件系列 Flap door fitting series

翻门配件系列

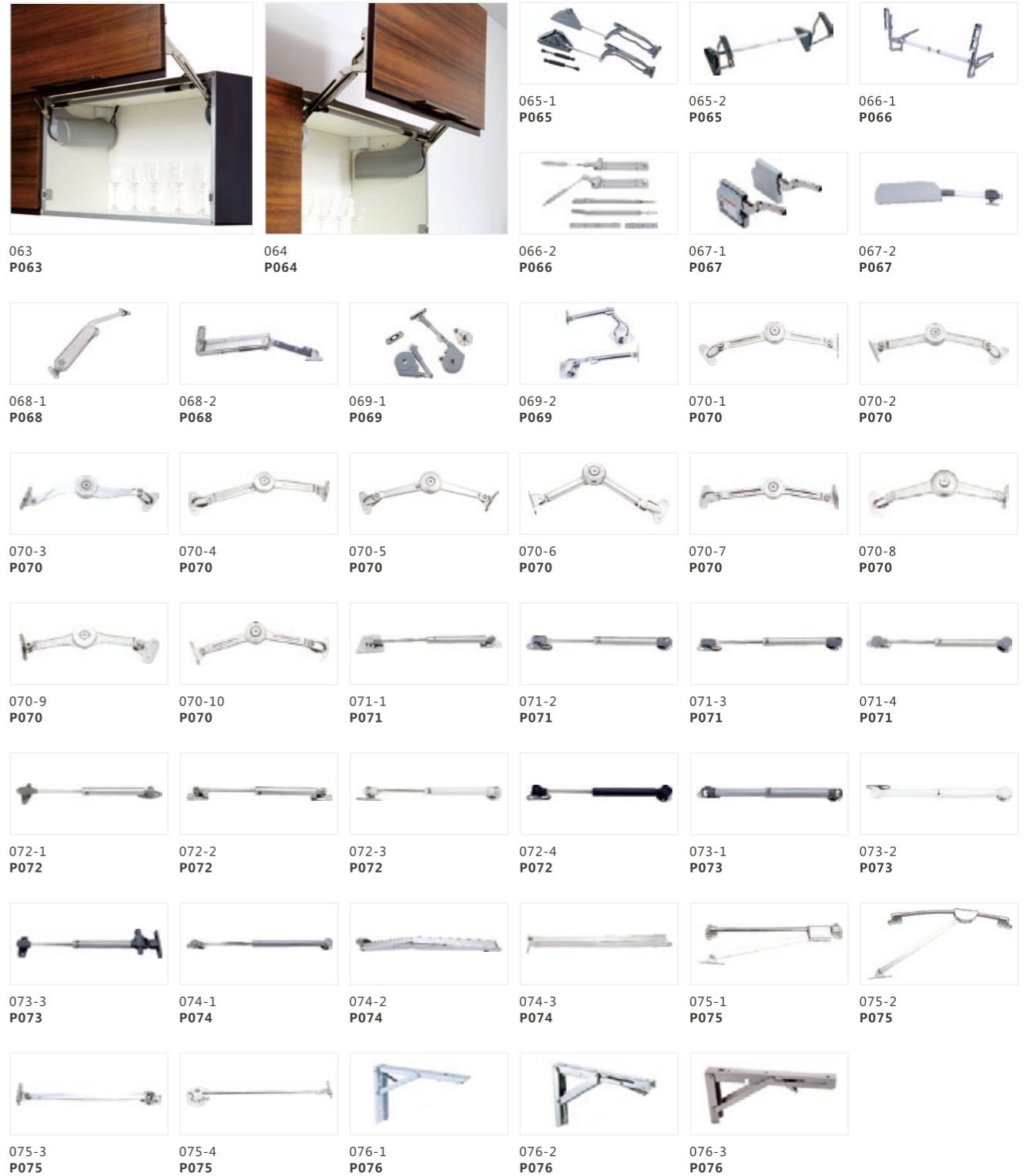

翻门配件系列  
Flap door fitting series

063 电动上翻平移支撑



产品信息  
Information

安装简单，调节方便  
Easy to install and easy to adjust

面板可实现三维调节  
Panel for 3D adjustment

自动电动伺服器，轻触控制器面板即自行开合  
Automatic electric servo, touch the controller panel to open and close

适用柜体高度：450-580mm  
Applicable cabinet height: 450-580mm

适用柜体宽度：1200mm以下  
Applicable cabinet width: 1200mm or less

适用最小柜体深度：300mm  
Applicable minimum cabinet depth: 300mm

带遇阻防夹功能  
With resistance to anti-clamp function

064 电动上翻平移支撑



产品信息  
Information

安装简单，调节方便  
Easy to install and easy to adjust

面板可实现三维调节  
Panel for 3D adjustment

力矩大小可根据面板重量调节  
Torque size can be adjusted according to panel weight

适用柜体高度：450-580mm  
Applicable cabinet height: 450-580mm

适用柜体最小宽度：1200mm  
Applicable cabinet minimum width: 1200mm

适用最小柜体深度：300mm  
Applicable minimum cabinet depth: 300mm

独立包装		1 省力装置			2 伸缩臂	
订货号 Item #	套/箱 Set/CTN	力矩 LF Power factor	订货号 Item #	套/箱 Set/CTN	订货号 Item #	套/箱 Set/CTN
FE01-E-A	3	1500-3000N	FE01SPA L/R	1	FE01TB L/R	1
FE01-E-B	3	2500-5000N	FE01SPB L/R	1		

3 横梁杆	
订货号 Item #	套/箱 Set/CTN
FE01HG	1

4 横梁杆连接件	
订货号 Item #	套/箱 Set/CTN
FE01LJ L/R	1

5 电动伺服系统	
订货号 Item #	套/箱 Set/CTN
FE01SFQ	1

6 翻门面板固定件	
订货号 Item #	套/箱 Set/CTN
FXMBGDJ L/R	1

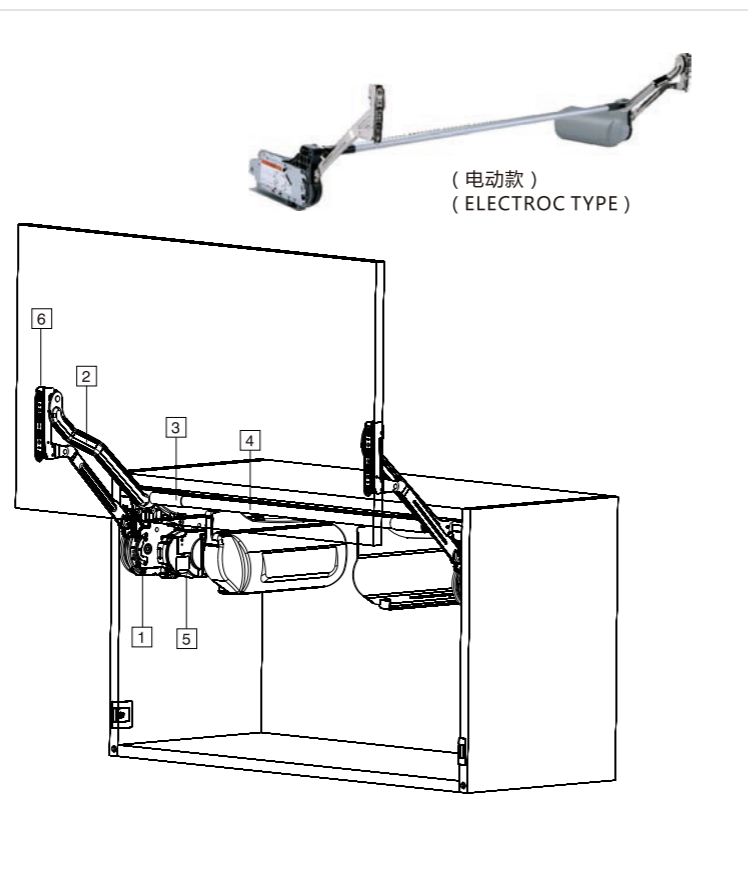

独立包装		1 省力装置			2 伸缩臂	
订货号 Item #	套/箱 Set/CTN	力矩 LF Power factor	订货号 Item #	套/箱 Set/CTN	订货号 Item #	套/箱 Set/CTN
FE01-H-A	4	1500-3000N	FE01SPA L/R	1	FE01TB L/R	1
FE01-H-B	4	2500-5000N	FE01SPB L/R	1		

3 横梁杆	
订货号 Item #	套/箱 Set/CTN
FE01HG	1

4 横梁杆连接件	
订货号 Item #	套/箱 Set/CTN
FE01LJ L/R	1

5 翻门面板固定件	
订货号 Item #	套/箱 Set/CTN
FXMBGDJ L/R	1

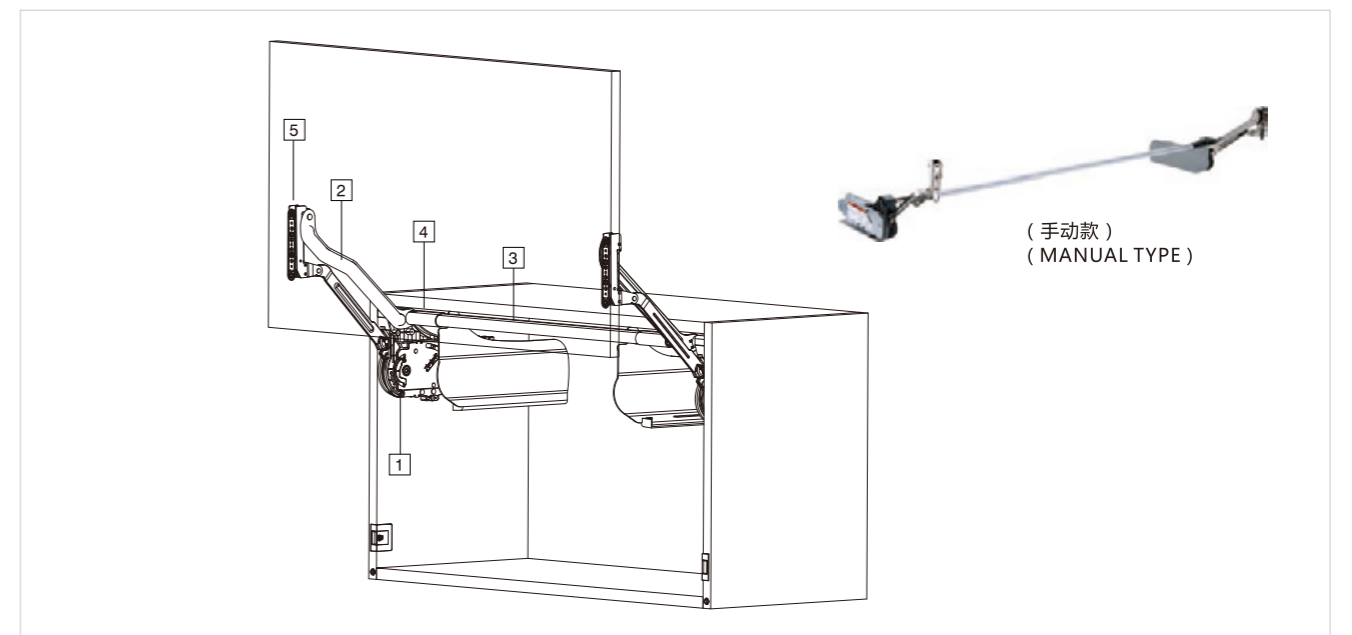

065-1 气动折叠上翻门系统



产品信息  
Information

主要材质：锌合金+铁+塑料  
Material: Zinc alloy+Steel+Plastic

表面处理：灰色  
Finish: Grey

产品特性：静音效果，内置缓冲装置使柜门使用轻柔安静  
Features: Silent system and excellent internal soft closing mechanism makes cabinet door close gently and quietly.

柜内宽度	门板重量
600-900 mm	4 kg
600-900 mm	9 kg

柜内高度	柜内深度
600-700 mm	min.250 mm

066-1 气动平移上翻门系统



产品信息  
Information

主要材质：铝合金+铁+塑料  
Material: Aluminum alloy + Steel + Plastic

表面处理：灰色  
Finish: Grey

产品特性：自关装置  
Features: Self-closing mechanism

柜内宽度	门板重量
600-900 mm	4 kg
900-1200 mm	9 kg

柜内高度	柜内深度
320-450mm	min.250 mm

065-2 气动斜移上翻门系统



产品信息  
Information

主要材质：锌合金+铁+塑料  
Material: Zinc alloy+Steel+Plastic

表面处理：灰色  
Finish: Grey

产品特性：静音效果，内置缓冲装置使柜门使用轻柔安静  
Features: Silent system and excellent internal soft closing mechanism makes cabinet door close gently and quietly.

柜内宽度	门板重量
600-800 mm	10.5kg

柜内高度	柜内深度
380-750 mm	min.182 mm

066-2 气动折叠上翻系统

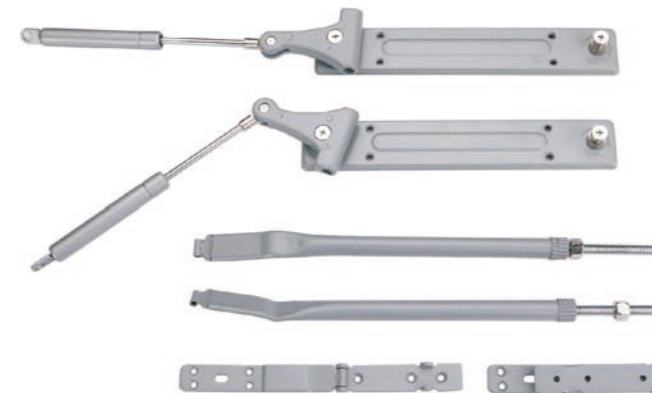

产品信息  
Information

主要材质：锌合金+铁+塑料  
Material: Zinc alloy+Steel+Plastic

表面处理：灰色  
Finish: Grey

产品特性：自关装置  
Features: Self-closing mechanism

柜内宽度	门板重量
600/720/800 mm	10kg

柜内高度	柜内深度
min.280 mm	600-900 mm



067-1 上翻门系统



产品信息  
Information

主要材质：锌合金+铁+塑料  
Material: Zinc alloy+Steel+Plastic

表面处理：灰色  
Finish: Grey

产品特性：静音效果，内置缓冲装置使柜门使用轻柔安静  
Features: Silent system and excellent internal soft closing mechanism makes cabinet door close gently and quietly.

柜内宽度	门板重量
max. 1200 mm	3-5 kg 6-8 kg 9-12 kg

柜内高度	柜内深度
300-600 mm	min.250 mm

068-1 重型油压支撑



产品信息  
Information

主要材质：锌合金+铁+塑料  
Material: Zinc alloy+Steel+Plastic

表面处理：灰色  
Finish: Grey

产品特性：自关装置  
Features: Self-closing mechanism

柜内宽度	门板重量
max. 700 mm	max. 6 kg

柜内高度	柜内深度
300-600mm	min.200 mm

067-2 液压上翻系统



产品信息  
Information

主要材质：锌合金+铁+塑料  
Material: Zinc alloy+Steel+Plastic

表面处理：灰色  
Finish: Grey

产品特性：自关装置  
Features: Self-closing mechanism.

柜内宽度	门板重量
400-700mm	3-4kg
700-900mm	4-5kg
900-1200mm	6-8kg
1200-1600mm	8-10kg

柜内高度	柜内深度
275-400 mm	min.250 mm

068-2 小精灵



产品信息  
Information

主要材质：铝合金+铁+塑料  
Material: Aluminum alloy + Steel + Plastic

表面处理：灰色  
Finish: Grey

产品特性：自关装置  
Features: Self-closing mechanism

柜内宽度	门板重量
600-900 mm	4 kg
900-1200 mm	9 kg

柜内高度	柜内深度
320-450mm	min.250 mm

069-1 液压支撑器



产品信息  
Information

主要材质：锌合金+铁+塑料  
Material: Zinc alloy+Steel+Plastic

表面处理：镀镍，镀铬  
Finish: Nickel, Chrome

产品特性：静音效果，缓冲装置使柜门关闭轻柔安静  
Features: Silent System. Soft closing mechanism makes cabinet door close quietly.

门高	门深	门宽	承重
300-450 mm	150 mm	600 mm	3 kg

产品型号	产品类型	产品功能
069-1A	长臂 Long-arm	任意停系统
069-1B	短臂 Short-arm	任意停系统
069-1C	长臂 Long-arm	缓冲系统
069-1D	短臂 Short-arm	缓冲系统

069-2 液压支撑器



产品信息  
Information

主要材质：锌合金+铁  
Material: Zinc alloy + Steel

表面处理：镀镍，镀铬  
Finish: Nickel, Chrome

产品特性：力道可调节，方便实用，180度任意停  
Features: Adjustable weight capacity, convenient and practical, stops in 180° open position.

柜内宽度	门板重量
max. 600 mm	max. 3 kg

柜内高度	柜内深度
300-450 mm	min. 150 mm

任意停支撑

产品信息  
Information

主要材质：锌合金  
Material: Zinc alloy

表面处理：镀镍  
Finish: Nickel

产品特性：任意角度停，顶翻门/上翻门/下翻门，三种打开方式，满足客户使用  
Features: Stops in any required open position. Different opening ways meet requirements, top opening, upward opening and down opening.

柜内高度	门板重量
300-500mm	3-5 kg



071-1 支撑



**主要材质** 铁+塑料  
**表面处理** 银灰色、金色、白色、黑色  
**产品承重** 30N-300N/20N-100N/20N-150N/40N-120N  
**产品特点** 采用国际先进喷涂技术，无毒环保，有效防止腐蚀及生锈；气撑承受力度可根据门板重量选择或定做

072-1 支撑



**主要材质** 铁+塑料  
**表面处理** 银灰色、金色、白色、黑色  
**产品承重** 30N-300N/20N-100N/20N-150N/40N-120N  
**产品特点** 采用国际先进喷涂技术，无毒环保，有效防止腐蚀及生锈；气撑承受力度可根据门板重量选择或定做

071-2 支撑



**主要材质** 铁+塑料  
**表面处理** 银灰色、金色、白色、黑色  
**产品承重** 30N-300N/20N-100N/20N-150N/40N-120N  
**产品特点** 采用国际先进喷涂技术，无毒环保，有效防止腐蚀及生锈；气撑承受力度可根据门板重量选择或定做

072-2 支撑



**主要材质** 铁+塑料  
**表面处理** 银灰色、金色、白色、黑色  
**产品承重** 30N-300N/20N-100N/20N-150N/40N-120N  
**产品特点** 采用国际先进喷涂技术，无毒环保，有效防止腐蚀及生锈；气撑承受力度可根据门板重量选择或定做

071-3 支撑



**主要材质** 铁+塑料  
**表面处理** 银灰色、金色、白色、黑色  
**产品承重** 30N-300N/20N-100N/20N-150N/40N-120N  
**产品特点** 采用国际先进喷涂技术，无毒环保，有效防止腐蚀及生锈；气撑承受力度可根据门板重量选择或定做

072-3 支撑



**主要材质** 铁+塑料  
**表面处理** 银灰色、金色、白色、黑色  
**产品承重** 30N-300N/20N-100N/20N-150N/40N-120N  
**产品特点** 采用国际先进喷涂技术，无毒环保，有效防止腐蚀及生锈；气撑承受力度可根据门板重量选择或定做

071-4 支撑



**主要材质** 铁+塑料  
**表面处理** 银灰色、金色、白色、黑色  
**产品承重** 30N-300N/20N-100N/20N-150N/40N-120N  
**产品特点** 采用国际先进喷涂技术，无毒环保，有效防止腐蚀及生锈；气撑承受力度可根据门板重量选择或定做

072-4 支撑



**主要材质** 铁+塑料  
**表面处理** 银灰色、金色、白色、黑色  
**产品承重** 30N-300N/20N-100N/20N-150N/40N-120N  
**产品特点** 采用国际先进喷涂技术，无毒环保，有效防止腐蚀及生锈；气撑承受力度可根据门板重量选择或定做

**安装示例**

**气动气撑**

产品用途：液压上翻  
 举力规格：50N/60N/80N/100N/120N/150N  
 适用范围：适用于上翻木门/铝框门（不同规格用于不同重木门）  
 气撑承受力度可根据门板重量选购或者订做，颜色可根据客户需求订做

Product use: hydraulic up turn  
 Product use: hydraulic up turn  
 SCOPE OF APPLICATION: suitable for upper turning wooden door / aluminum frame door  
 (different specifications for different heavy wooden doors)  
 Air Support Strength can be selected according to the weight of the door panel or custom-made, color can be customized according to customer needs

N数	门板高度(mm)	门板重量(KG)	80°				90°				100°			
			300	400	500	600	300	400	500	600	300	400	500	600
80			≤2.6	≤2.2	≤1.7	≤1.3	≤2.4	≤2.1	≤1.6	≤1.2	≤2.1	≤1.7	≤1.4	≤1.0
100			≤3.3	≤2.7	≤2.2	≤1.6	≤3.0	≤2.5	≤2.0	≤1.5	≤2.6	≤2.2	≤1.7	≤1.3
120			≤4.0	≤3.3	≤2.6	≤2.0	≤3.6	≤3.0	≤2.4	≤1.8	≤3.2	≤2.6	≤2.1	≤1.6
140			≤4.7	≤3.9	≤3.2	≤2.5	≤4.2	≤3.5	≤2.8	≤2.1	≤2.8	≤3.2	≤2.5	≤1.9

073-1 支撑



**主要材质** 铁+塑料  
**表面处理** 银灰色、金色、白色、黑色  
**产品承重** 30N-300N/20N-100N/20N-150N/40N-120N  
**产品特点** 采用国际先进喷涂技术，无毒环保，有效防止腐蚀及生锈；气撑承受力度可根据门板重量选择或定做

074-1 榻榻米支撑



**主要材质** 铁+塑料  
**表面处理** 银灰色、金色、白色、黑色  
**产品承重** 30N-300N/20N-100N/20N-150N/40N-120N  
**产品特点** 采用国际先进喷涂技术，无毒环保，有效防止腐蚀及生锈；气撑承受力度可根据门板重量选择或定做

073-2 支撑



**主要材质** 铁+塑料  
**表面处理** 银灰色、金色、白色、黑色  
**产品承重** 30N-300N/20N-100N/20N-150N/40N-120N  
**产品特点** 采用国际先进喷涂技术，无毒环保，有效防止腐蚀及生锈；气撑承受力度可根据门板重量选择或定做

074-2 榻榻米支撑



**主要材质** 铁  
**表面处理** 银灰色、金色、白色、黑色  
**产品承重** 30N-300N/20N-100N/20N-150N/40N-120N  
**产品特点** 采用国际先进喷涂技术，无毒环保，有效防止腐蚀及生锈；气撑承受力度可根据门板重量选择或定做

073-3 缓冲气撑



**主要材质** 铁+塑料  
**表面处理** 银灰色、金色、白色、黑色  
**产品承重** 30N-300N/20N-100N/20N-150N/40N-120N  
**产品特点** 采用国际先进喷涂技术，无毒环保，有效防止腐蚀及生锈；气撑承受力度可根据门板重量选择或定做

074-3 榻榻米小金刚支撑



**主要材质** 铁  
**表面处理** 银灰色、金色、白色、黑色  
**产品承重** 30N-300N/20N-100N/20N-150N/40N-120N  
**产品特点** 采用国际先进喷涂技术，无毒环保，有效防止腐蚀及生锈；气撑承受力度可根据门板重量选择或定做

075-1 机械支撑



**主要材质** 锌合金+铁  
**表面处理** 镀镍  
**产品特点** 下翻门

075-2 机械支撑



**主要材质** 铁  
**表面处理** 镀镍  
**产品特点** 下翻门

075-3 机械支撑



**主要材质** 铁  
**表面处理** 镀镍  
**产品特点** 下翻门  
**尺寸** 150/ 200/ 250/300mm

075-4 机械支撑



**主要材质** 铁  
**表面处理** 镀镍  
**产品特点** 上翻门  
**直径尺寸**  $\phi$ 4、5、6mm  
**长度尺寸** 200 / 220 / 230 mm

076-1 10寸弹簧折叠支架



**主要材质** 铁/不锈钢  
**表面处理** 镀镍  
**产品规格** 8寸/10寸/12寸/14寸/16寸

076-2 12寸K型折叠支架



**主要材质** 铁/不锈钢  
**表面处理** 镀镍  
**产品规格** 8寸/10寸/12寸/14寸/16寸

076-3 10寸弹簧折叠支架



**主要材质** 铁/不锈钢  
**表面处理** 镀镍  
**产品规格** 8寸/10寸/12寸/14寸/16寸



采用不锈钢材质，防水防锈，抗氧化，使用寿命更长。  
拉丝工艺，表面更平滑。  
一按折叠设计，节省空间，收纳更方便。



免拉手，可调节  
一按即开，柜门新时代  
简约设计，让生活更美好更整洁

Functional accessory series.  
Open at the touch of a button, a new era of cabinet doors.  
Simple design, make life better and cleaner.

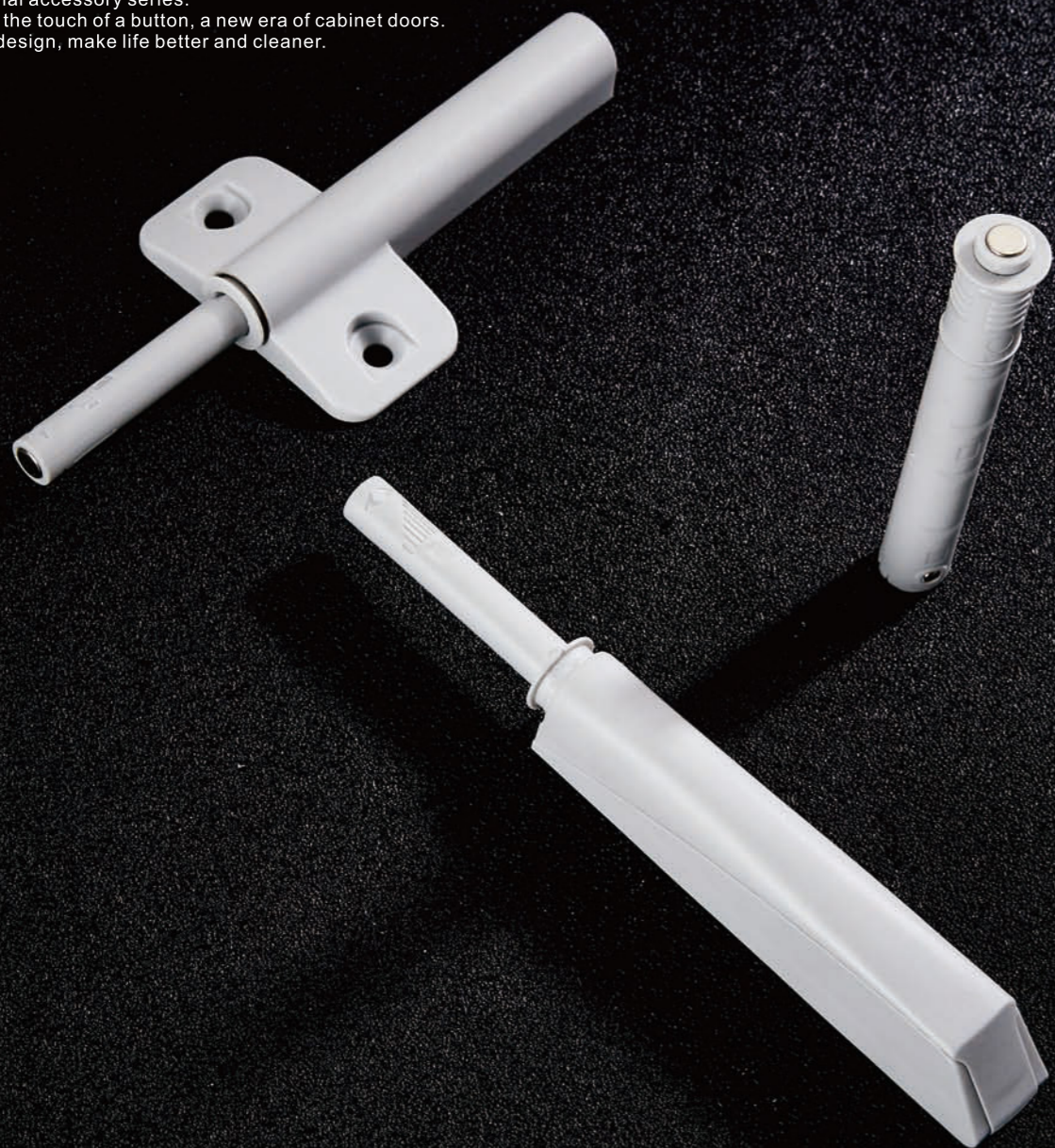

反弹器&缓冲器系列  
Bouncer & Buffer Series

反弹器&缓冲器系列  
Bouncer & Buffer Series

反弹器&缓冲器系列

079-1 P079	079-2 P079	079-3 P079	079-4 P079	079-5 P079	080-1 P080	080-2 P080	080-3 P080
080-4 P080	080-5 P080	080-6 P080	080-7 P080	080-8 P080	081-1 P081	081-2 P081	081-3 P081
081-4 P081	081-5 P081	081-6 P081	081-7 P081	081-8 P081	082-1 P082	082-2 P082	082-3 P082
082-4 P082	082-5 P082	082-6 P082	082-7 P082	082-8 P082	083-1 P083	083-2 P083	083-3 P083
083-4 P083	083-5 P083	083-6 P083	083-7 P083	083-8 P083	084-1 P084	084-2 P084	084-3 P084
084-4 P084	084-5 P084	084-6 P084	084-7 P084	084-8 P084	085-1 P085	085-2 P085	085-3 P085
085-4 P085	085-5 P085	085-6 P085	085-7 P085	085-8 P085			
086-1 P086				086-2 P086			
086-3 P086				086-4 P086			

反弹器&缓冲器系列

BOUNCER & BUFFER SERIES

079-1



**主要材质** 塑料+铁  
**表面处理** 白色/灰色  
Material: Plastic+Steel  
Finish: White/Grey



079-2



**主要材质** 塑料+铁  
**表面处理** 白色/灰色  
Material: Plastic+Steel  
Finish: White/Grey

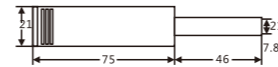

079-3



**主要材质** 塑料+铁  
**表面处理** 白色/灰色  
Material: Plastic+Steel  
Finish: White/Grey

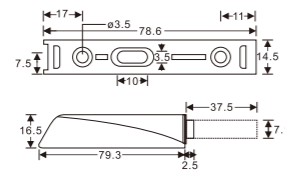

079-4



**主要材质** 塑料+铁  
**表面处理** 白色/灰色  
Material: Plastic+Steel  
Finish: White/Grey

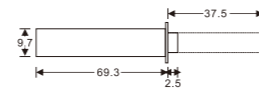

079-5



**主要材质** 塑料+铁  
**表面处理** 白色/灰色  
Material: Plastic+Steel  
Finish: White/Grey

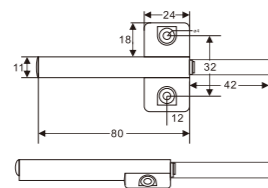

080-1



**主要材质** 塑料+铝合金  
**表面处理** 银色  
Material: Plastic+Aluminium Alloy  
Finish: Silver

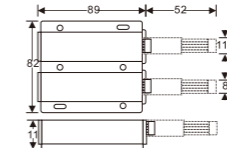

080-2

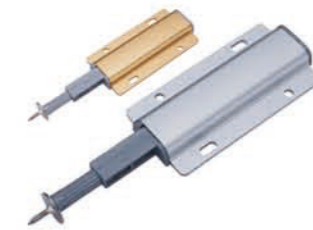

**主要材质** 塑料+铝合金  
**表面处理** 金色/银色  
Material: Plastic+Aluminium Alloy  
Finish: Gold/Silver

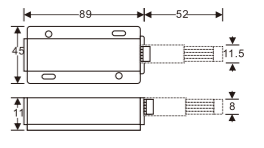

080-3



**主要材质** 塑料+铁  
**表面处理** 白色/灰色  
Material: Plastic+Steel  
Finish: White / Grey

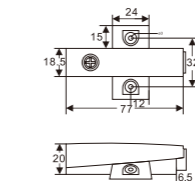

080-4



**主要材质** 塑料+铁/不锈钢  
**表面处理** 灰色  
Material: Plastic+Steel/Stainless steel  
Finish: Grey

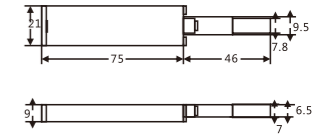

080-5



**主要材质** 塑料+铁  
**表面处理** 白色/灰色  
Material: Plastic+Steel  
Finish: White / Grey

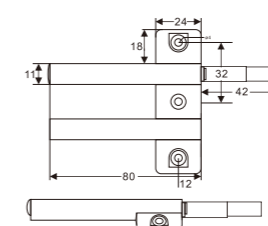

080-6



**主要材质** 塑料+铁  
**表面处理** 白色/灰色  
Material: Plastic+Steel  
Finish: White / Grey

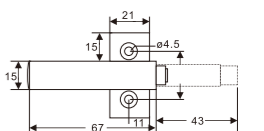

080-7



**主要材质** 塑料+铁  
**表面处理** 白色/灰色  
Material: Plastic+Steel  
Finish: White / Grey

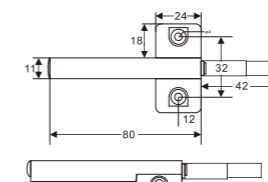

080-8



**主要材质** 塑料+铁  
**表面处理** 白色/灰色  
Material: Plastic+Steel  
Finish: White / Grey

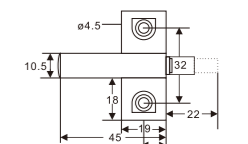





083-1



**主要材质** 塑料+铁  
**表面处理** 白色/棕色/镀锌  
Material: Plastic+Steel  
Finish: White/Brown/Zinc

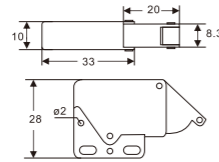

083-2



**主要材质** 塑料+铁  
**表面处理** 白色/棕色/镀锌  
Material: Plastic+Steel  
Finish: White/Brown/Zinc

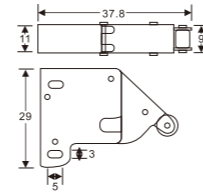

084-1



**主要材质** 塑料+铁  
**表面处理** 棕色  
Material: Plastic+Steel  
Finish: Brown

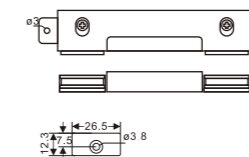

084-2



**主要材质** 塑料+铁  
**表面处理** 棕色  
Material: Plastic+Steel  
Finish: Brown

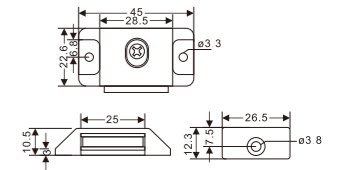

083-3



**主要材质** 塑料+铁  
**表面处理** 镀锌  
Material: Plastic+Steel  
Finish: Zinc Plated

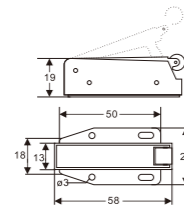

083-4



**主要材质** 塑料+铁  
**表面处理** 白色/黑色/米黄色  
Material: Plastic+Steel  
Finish: White/Black/Beige

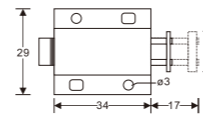

084-3



**主要材质** 塑料+铁  
**表面处理** 棕色  
Material: Plastic+Steel  
Finish: Brown

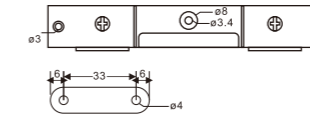

084-4



**主要材质** 塑料+铁  
**表面处理** 棕色  
Material: Plastic+Steel  
Finish: Brown

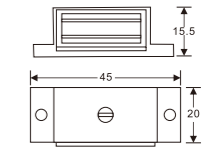

083-5



**主要材质** 塑料+铁  
**表面处理** 白色/灰色  
Material: Plastic+Steel  
Finish: White/Grey

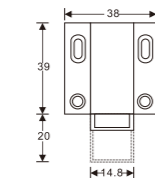

083-6



**主要材质** 塑料+铁  
**表面处理** 白色/灰色  
Material: Plastic+Steel  
Finish: White/Grey

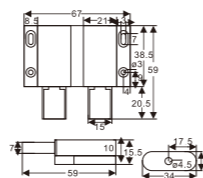

084-5



**主要材质** 塑料+铁  
**表面处理** 白色/黑色/棕色/灰色  
Material: Plastic+Steel  
Finish: White/Black/Brown/Grey

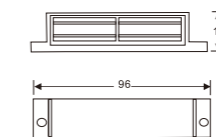

084-6



**主要材质** 塑料+铁  
**表面处理** 棕色/白色/黑色  
Material: Plastic+Steel  
Finish: Brown/White/Black

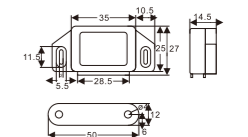

083-7



**主要材质** 塑料+铁  
**表面处理** 白色  
Material: Plastic+Steel  
Finish: White

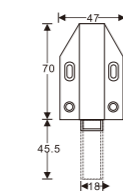

083-8



**主要材质** 塑料+铁  
**表面处理** 白色  
Material: Plastic+Steel  
Finish: White

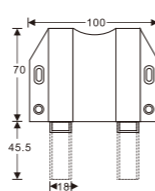

084-7



**主要材质** 塑料+铁  
**表面处理** 棕色/白色/黑色  
Material: Plastic+Steel  
Finish: Brown/White/Black

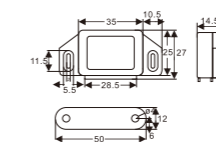

084-8



**主要材质** 塑料+铁  
**表面处理** 白色/棕色/黑色  
Material: Plastic+Steel  
Finish: White/Brown/Black

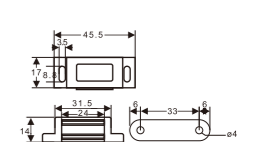

085-1



**主要材质** 塑料+铁  
**表面处理** 白色/棕色  
Material: Plastic+Steel  
Finish: White/Grey

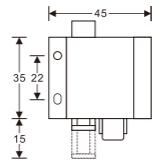

085-2



**主要材质** 塑料+铁  
**表面处理** 白色/棕色  
Material: Plastic+Steel  
Finish: White/Brown

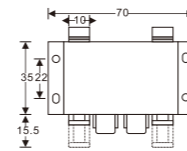

086-1

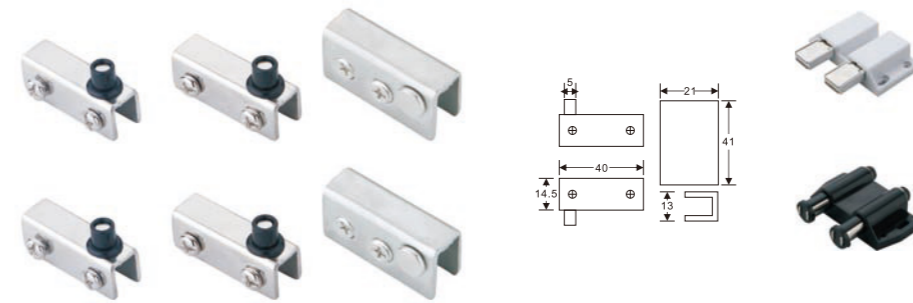

**主要材质** 塑料+铁  
**表面处理** 镀镍/镀铬/镀金  
Material: Plastic+Steel  
Finish: Nickel/Chrome/Gold

085-3



**主要材质** 塑料+铁  
**表面处理** 棕色/白色  
Material: Plastic+Steel  
Finish: Brown/white

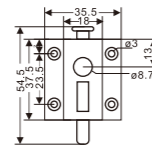

085-4



**主要材质** 塑料+铁  
**表面处理** 棕色/白色  
Material: Plastic+Steel  
Finish: Brown/White

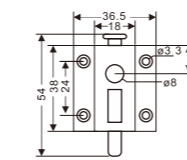

086-2

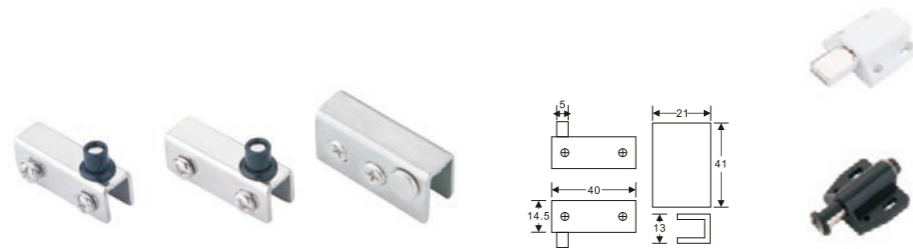

**主要材质** 塑料+铁  
**表面处理** 镀镍/镀铬/镀金  
Material: Plastic+Steel  
Finish: Nickel/Chrome/Gold

085-5



**主要材质** 塑料  
**表面处理** 透明/白色  
Material: Plastic  
Finish: Transparent/white

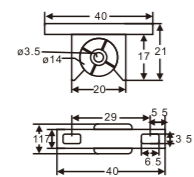

085-6



**主要材质** 锌合金  
**表面处理** 原色/镀镍  
Material: Zinc alloy  
Finish: Primary color/Nickel

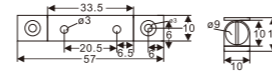

086-3

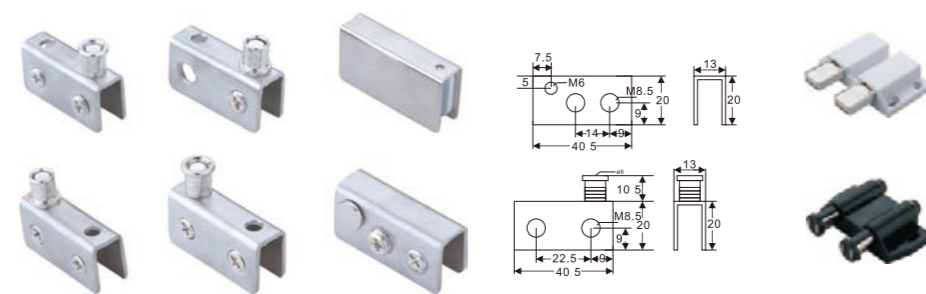

**主要材质** 不锈钢+铁  
**表面处理** 拉丝  
Material: SS+Steel  
Finish: Satin

085-7



**主要材质** 铁  
**表面处理** 青古铜/红古铜/镀锌  
Material: Steel  
Finish: Antique bronze / Antique cooper / Zinc

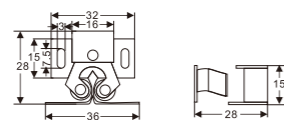

085-8



**主要材质** 铁  
**表面处理** 青古铜/红古铜/镀锌  
Material: Steel  
Finish: Antique bronze / Antique cooper / Zinc

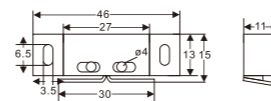

086-4

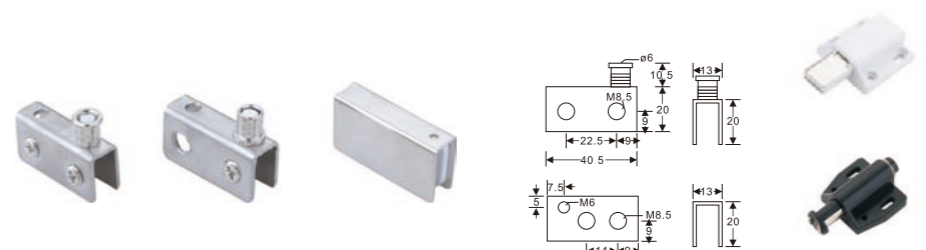

**主要材质** 不锈钢+铁  
**表面处理** 拉丝  
Material: SS+Steel  
Finish: Satin

全新改进版  
防脱落结构  
省空间 更安全

New and improved  
Anti-sloughing structure  
It saves space, it's safer

吊  
码  
系  
列  
Hanging code series

吊码系列  
HANGING CODE SERIES



吊码系列 Hanging code series

吊码系列



089-1  
P089



089-2  
P089



089-3  
P089



089-4  
P089



090-1  
P090



090-2  
P090



090-3  
P090



090-4  
P090



092-1  
P092



092-2  
P092



092-3  
P092



092-4  
P092



093-1  
P093



093-2  
P093



093-3  
P093



093-4  
P093



094-1  
P094



094-2  
P094



094-3  
P094



094-4  
P094

吊  
码  
系  
列  
Hanging code series

089-1

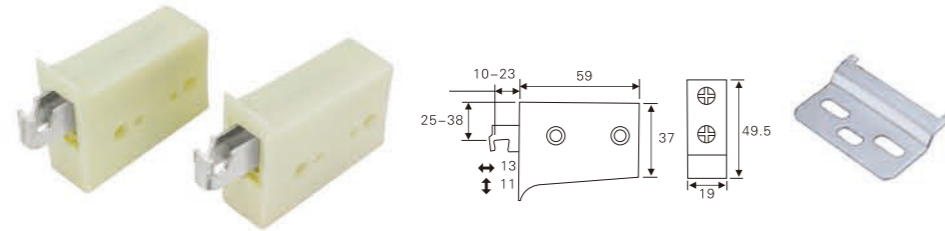

**主要材质** 塑料 + 铁  
**表面处理** 白色 / 米黄色  
**最大承重** 110 公斤/付  
 Material: Plastic + Steel  
 Finish: White / Ivory  
 Loading capacity: 110 kg/pair

090-1

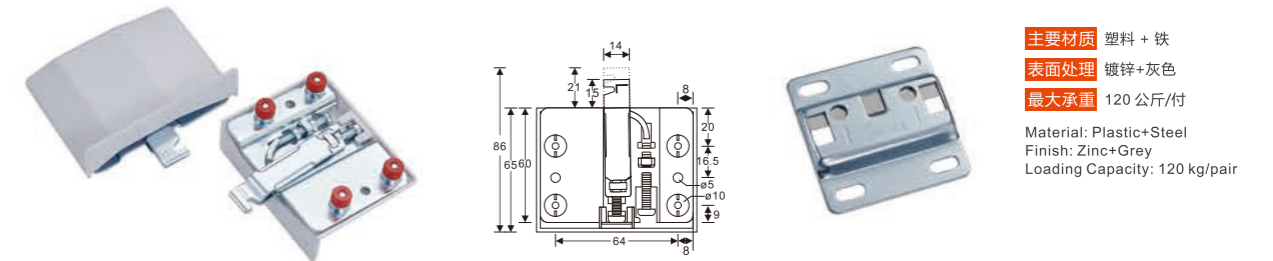

**主要材质** 塑料 + 铁  
**表面处理** 镀锌+灰色  
**最大承重** 120 公斤/付  
 Material: Plastic+Steel  
 Finish: Zinc+Grey  
 Loading Capacity: 120 kg/pair

089-2

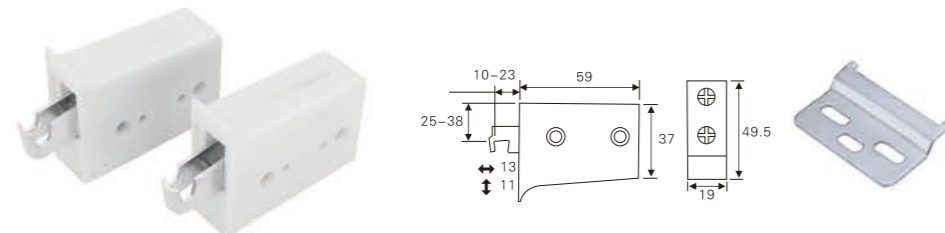

**主要材质** 塑料 + 铁  
**表面处理** 白色 / 米黄色  
**最大承重** 110 公斤/付  
 Material: Plastic + Steel  
 Finish: White / Ivory  
 Loading capacity: 110 kg/pair

090-2

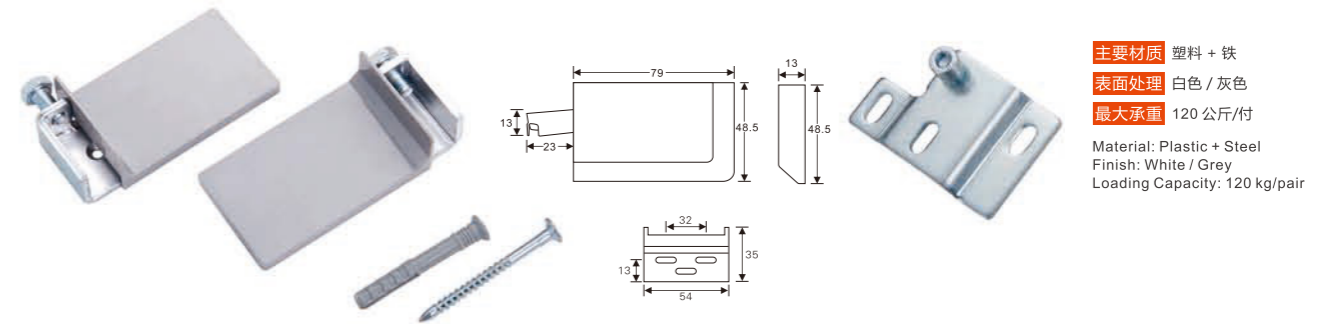

**主要材质** 塑料 + 铁  
**表面处理** 白色 / 灰色  
**最大承重** 120 公斤/付  
 Material: Plastic + Steel  
 Finish: White / Grey  
 Loading Capacity: 120 kg/pair

089-3

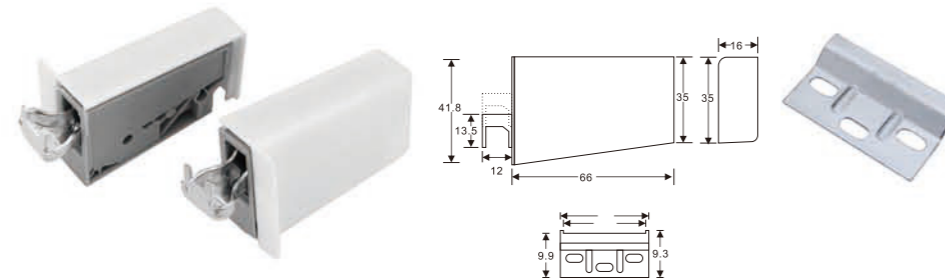

**主要材质** 塑料 + 铁  
**表面处理** 白色 / 灰色  
**最大承重** 110 公斤/付  
 Material: Plastic + Steel  
 Finish: White / Grey  
 Loading Capacity: 110 kg/pair

090-3

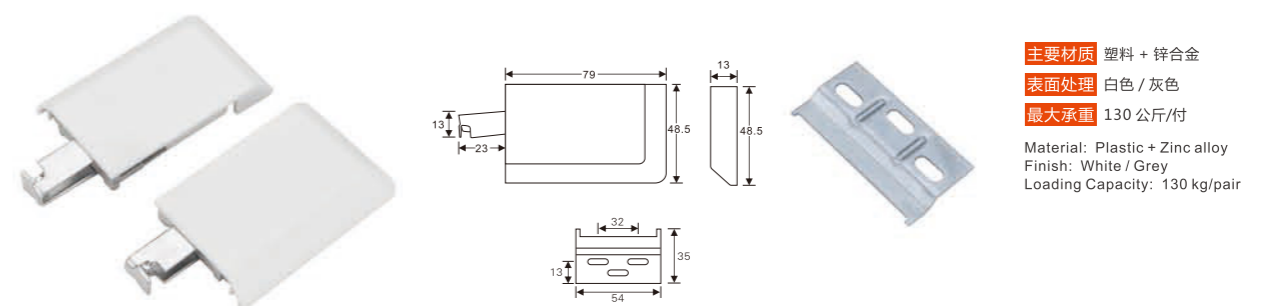

**主要材质** 塑料 + 锌合金  
**表面处理** 白色 / 灰色  
**最大承重** 130 公斤/付  
 Material: Plastic + Zinc alloy  
 Finish: White / Grey  
 Loading Capacity: 130 kg/pair

089-4

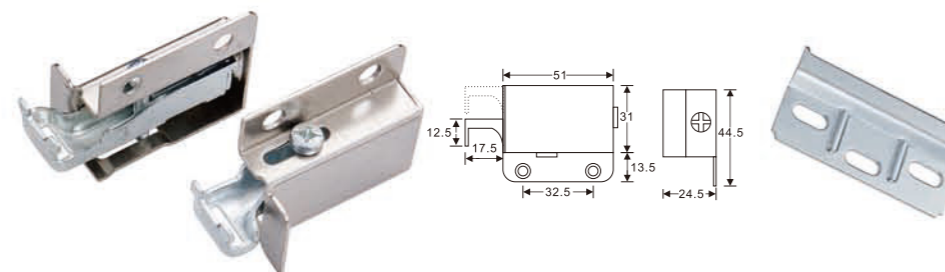

**主要材质** 铁  
**表面处理** 镀锌  
**最大承重** 120 公斤/付  
 Material: Steel  
 Finish: Zinc  
 Loading Capacity: 120 kg/pair

090-4



**主要材质** 塑料  
**表面处理** 灰色/米黄色/白色  
**最大承重** -----  
 Material: Plastic  
 Finish: Grey / Beige / White  
 Loading capacity: -----

吊码系列  
Hanging code series

吊码系列  
Hanging code series

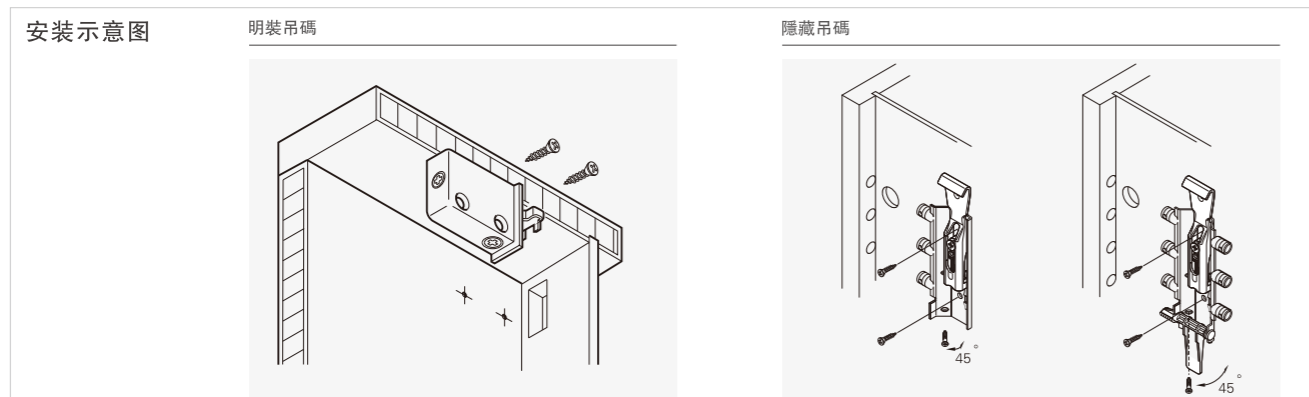

092-1

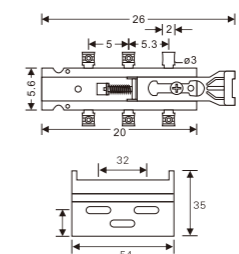

主要材质 铁  
表面处理 镀锌  
最大承重 130公斤/付  
Material: Steel  
Finish: Zinc  
Loading Capacity: 130 kg/pair

092-2

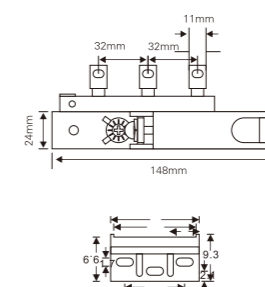
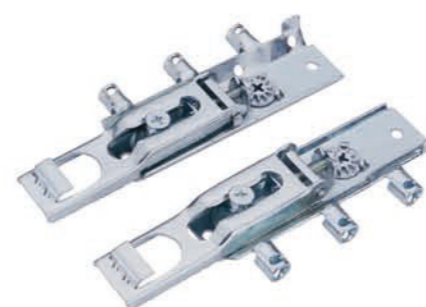

主要材质 铁  
表面处理 镀锌  
最大承重 130公斤/付  
Material: Steel  
Finish: Zinc  
Loading Capacity: 130 kg/pair

092-3

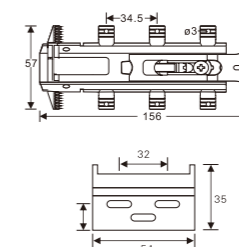

主要材质 铁  
表面处理 镀锌  
最大承重 130公斤/付  
Material: Steel  
Finish: Zinc  
Loading Capacity: 130 kg/pair

092-4

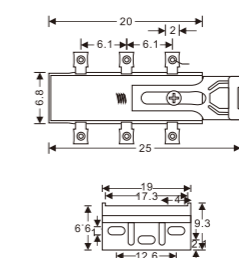
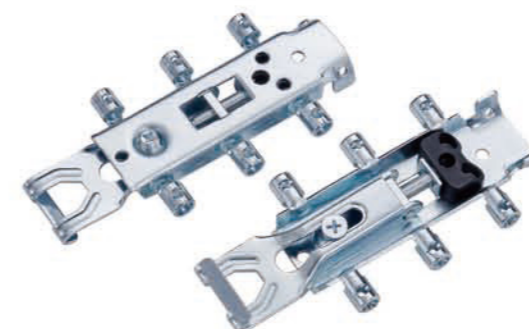

主要材质 铁  
表面处理 镀锌  
最大承重 130公斤/付  
Material: Steel  
Finish: Zinc  
Loading Capacity: 130 kg/pair

093-1

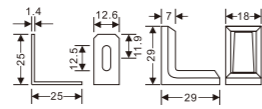

**主要材质** 铁+塑料  
**表面处理** 镀锌+黑色  
**最大承重** 120公斤/付  
 Material: Steel + Plastic  
 Finish: Zinc+Brown  
 Loading Capacity: 120 kg/pair

094-1

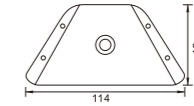

**主要材质** 铁  
**表面处理** 彩锌  
 Material: Steel  
 Finish: Color zinc

093-2

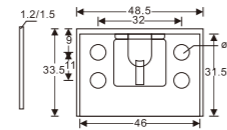

**主要材质** 铁+塑料  
**表面处理** 灰色/白色  
**最大承重** 120公斤/付  
**厚度** 1.2/1.5 mm  
 Material: Steel + Plastic  
 Finish: Gray/white  
 Loading Capacity: 120 kg/pair  
 Thickness: 1.2/1.5mm

094-2

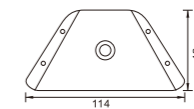

**主要材质** 铁  
**表面处理** 彩锌  
 Material: Steel  
 Finish: Color zinc

093-3

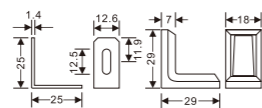
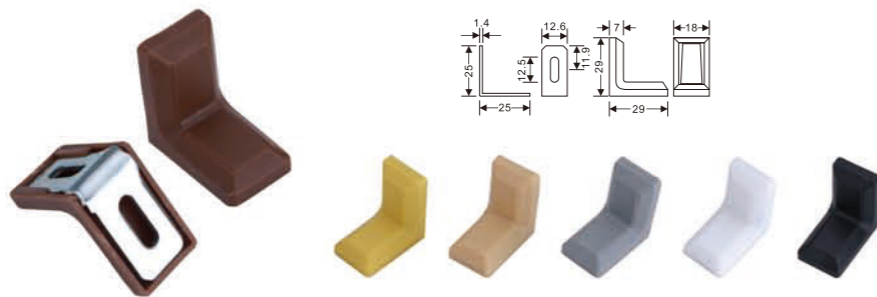

**主要材质** 铁+塑料  
**表面处理** 棕色/黄色/浅咖/灰色/白色/黑色  
 Material: Steel + Plastic  
 Finish: Brown/yellow/light coffee Gray/white/black

094-3

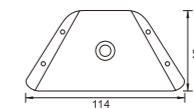

**主要材质** 铁  
**表面处理** 黑色  
 Material: Steel  
 Finish: Black

093-4

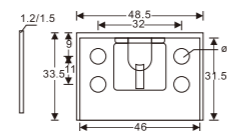
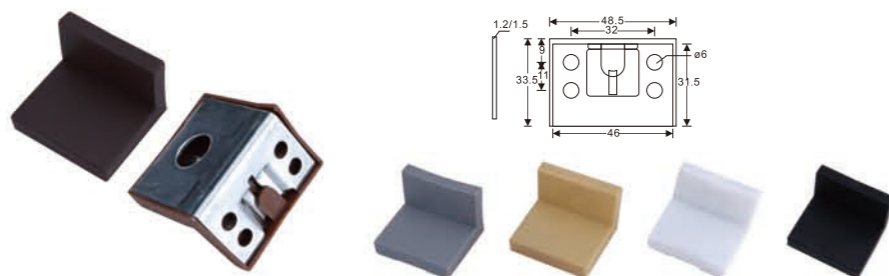

**主要材质** 铁+塑料  
**表面处理** 棕色/浅咖/灰色/白色/黑色  
**最大承重** 120公斤/付  
**厚度** 1.2/1.5 mm  
 Material: Steel + Plastic  
 Finish: Brown/yellow/light coffee Gray/white/black  
 Loading Capacity: 120 kg/pair  
 Thickness: 1.2/1.5mm

094-4

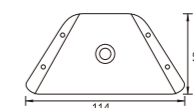

**主要材质** 铁  
**表面处理** 白色  
 Material: Steel  
 Finish: White

耐潮耐锈，承重更强  
开拓你的室内空间  
小部件，大空间

Resistant to moisture and rust,  
load-bearing more powerful open up your  
interior space small parts, large space

层板托&玻璃夹系列  
Shelf Support & Glass Clamp Series

层板托&玻璃夹系列  
SHELF SUPPORT & GLASS CLAMP SERIES



层板托&玻璃夹系列

097-1 P097	097-2 P097	097-3 P097	097-4 P097	097-5 P097	097-6 P097	097-7 P097	097-8 P097
098-1 P098	098-2 P098	098-3 P098	098-4 P098	098-5 P098	099-1 P099	099-2 P099	099-3 P099
100-1 P100	100-2 P100	100-3 P100	100-4 P100	100-5 P100	100-6 P100	100-7 P100	100-8 P100
101-1 P101	101-2 P101	101-3 P101	101-4 P101	101-5 P101	101-6 P101	101-7 P101	101-8 P101
102-1 P102	102-2 P102	102-3 P102	102-4 P102	102-5 P102	102-6 P102	102-7 P102	102-8 P102
103-1 P103	103-2 P103	103-3 P103	103-4 P103	103-5 P103	103-6 P103	103-7 P103	103-8 P103
104-1 P104	104-2 P104	104-3 P104	104-4 P104	104-5 P104	104-6 P104	104-7 P104	104-8 P104
105-1 P105	105-2 P105	105-3 P105	105-4 P105	105-5 P105	105-6 P105	105-7 P105	105-8 P105
106-1 P106	106-2 P106	106-3 P106	106-4 P106	106-5 P106	106-6 P106	106-7 P106	106-8 P106

层板托&玻璃夹系列  
Shelf Support & Glass Clamp Series

097-1



**主要材质** 锌合金  
**表面处理** 镀镍  
Material: Zinc alloy  
Finish: Nickel

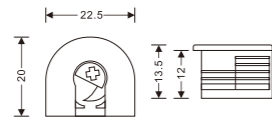

097-2



**主要材质** 锌合金  
**表面处理** 镀镍  
Material: Zinc alloy  
Finish: Nickel

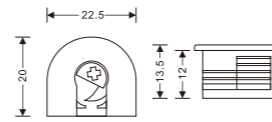

098-1



**主要材质** 锌合金  
**表面处理** 镀镍  
Material: Zinc alloy  
Finish: Nickel

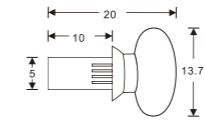

098-2



**主要材质** 锌合金  
**表面处理** 镀镍  
Material: Zinc alloy  
Finish: Nickel

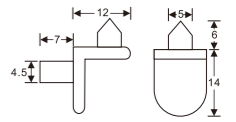

097-3



**主要材质** 锌合金  
**表面处理** 镀镍  
Material: Zinc alloy  
Finish: Nickel

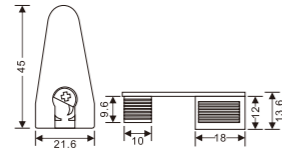

097-4



**主要材质** 锌合金  
**表面处理** 镀镍  
**适用厚度** 3-10mm  
Material: Zinc alloy  
Finish: Nickel  
Suitable thickness: 3-10mm

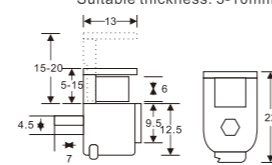

098-3



**主要材质** 锌合金  
**表面处理** 镀镍  
Material: Zinc alloy  
Finish: Nickel

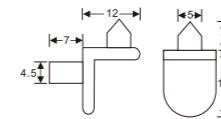

098-4



**主要材质** 锌合金  
**表面处理** 镀镍  
Material: Zinc alloy  
Finish: Nickel

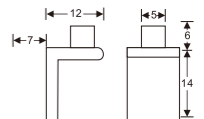

097-5



**主要材质** 锌合金  
**表面处理** 镀镍  
Material: Zinc alloy  
Finish: Nickel

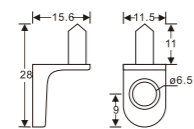

097-6



**主要材质** 锌合金  
**表面处理** 镀镍  
Material: Zinc alloy  
Finish: Nickel

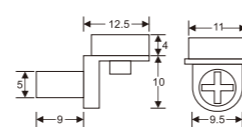

098-5



**主要材质** 锌合金  
**表面处理** 镀镍  
Material: Zinc alloy  
Finish: Nickel

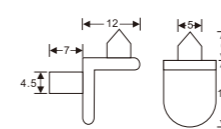

097-7



**主要材质** 锌合金  
**表面处理** 镀镍  
Material: Zinc alloy  
Finish: Nickel

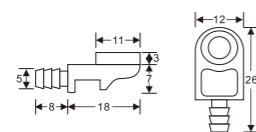

097-8



**主要材质** 锌合金  
**表面处理** 镀镍  
Material: Zinc alloy  
Finish: Nickel

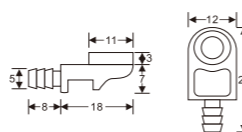



099-1



**主要材质** 锌合金  
**表面处理** 黑色  
Material: Zinc alloy  
Finish: Black

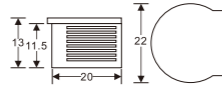

099-2



**主要材质** 锌合金  
**表面处理** 黑色  
Material: Zinc alloy  
Finish: Black

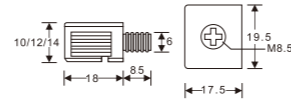

099-3



**主要材质** 锌合金  
**表面处理** 白色  
Material: Zinc alloy  
Finish: White

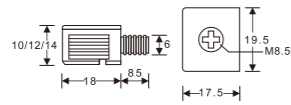

100-1



**主要材质** 锌合金  
**表面处理** 白色/棕色/黑色  
Material: Zinc alloy  
Finish: White/Brown/Black

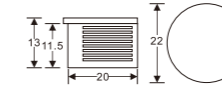

100-2



**主要材质** 锌合金  
**表面处理** 白色/黑色  
Material: Zinc alloy  
Finish: White / Black

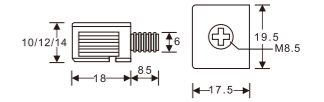

100-3



**主要材质** 锌合金+塑料  
**表面处理** 白色/棕色  
Material: Zinc alloy+Plastic  
Finish: White / Brown

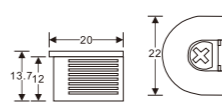

100-4



**主要材质** 锌合金+塑料  
**表面处理** 白色/棕色  
Material: Zinc alloy+Plastic  
Finish: White / Brown

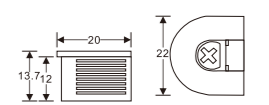

100-5



**主要材质** 锌合金+塑料  
**表面处理** 白色/棕色  
Material: Zinc alloy+Plastic  
Finish: White / Brown

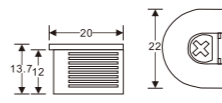

100-6



**主要材质** 锌合金+塑料  
**表面处理** 白色/棕色  
Material: Zinc alloy+Plastic  
Finish: White / Brown

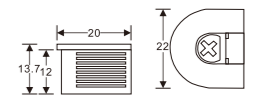

100-7



**主要材质** 锌合金+塑料  
**表面处理** 白色/棕色  
Material: Zinc alloy+Plastic  
Finish: White / Brown

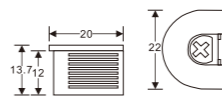

100-8



**主要材质** 锌合金+塑料  
**表面处理** 白色/棕色  
Material: Zinc alloy+Plastic  
Finish: White / Brown

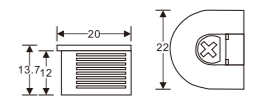

牢靠稳固,承重更强  
耐潮耐锈,用途广泛  
小而精美,安装方便

Reliable and stable,  
bearing more resistant to  
moisture and rust,  
a wide range of small  
and exquisite, easy installation

101-1



**主要材质** 锌合金+塑料  
**表面处理** 白色/棕色  
Material: Zinc alloy+Plastic  
Finish: White / Brown

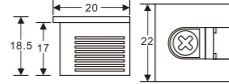

101-2



**主要材质** 锌合金+塑料  
**表面处理** 白色、灰色、米黄色  
Material: Zinc alloy+Plastic  
Finish: White/Grey/Cream

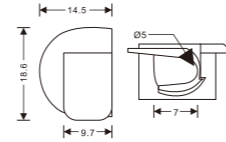

102-1



**主要材质** 塑料+铁  
**表面处理** 白色/透明  
**产品规格** 3/5 mm  
Material: Plastic+Steel  
Finish: White, Transparent/  
Black / beige  
Size: 3/5 mm

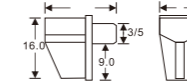

102-2



**主要材质** 塑料+铁  
**表面处理** 白色/透明/黑色/米黄  
**产品规格** 3/5 mm  
Material: Plastic+Steel  
Finish: White, Transparent/  
Black / beige  
Size: 3/5 mm

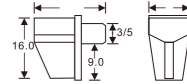

101-3



**主要材质** 锌合金+塑料  
**表面处理** 白色、棕色  
Material: Zinc alloy+Plastic  
Finish: White / Brown

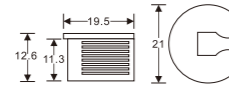

101-4



**主要材质** 铁+塑料  
**表面处理** 白色、灰色  
Material: Zinc alloy+Plastic  
Finish: White/Grey

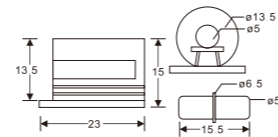

102-3



**主要材质** 塑料+铁  
**表面处理** 白色/透明/黑色/米黄  
**产品规格** 3/5 mm  
Material: Plastic+Steel  
Finish: White, Transparent/  
Black / beige  
Size: 3/5 mm

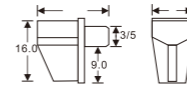

102-4



**主要材质** 塑料+铁  
**表面处理** 白色/透明/黑色/米黄  
**产品规格** 3/5 mm  
Material: Plastic+Steel  
Finish: White, Transparent/  
Black / beige  
Size: 3/5 mm

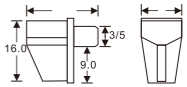

101-5



**主要材质** 铁+塑料  
**表面处理** 白色  
Material: Steel+Plastic  
Finish: White

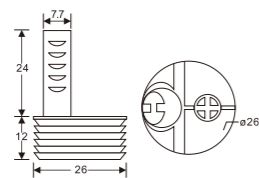

101-6



**主要材质** 塑料  
**表面处理** 白色、灰色  
Material: Plastic  
Finish: White/Grey

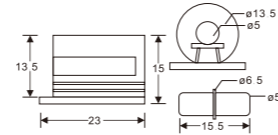

102-5



**主要材质** 塑料+铁  
**表面处理** 白色  
**产品规格** 16/18 mm  
Material: Plastic+Steel  
Finish: White  
Size : 16/18 mm

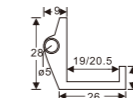

102-6



**主要材质** 塑料+铁  
**表面处理** 白色  
**产品规格** 16/18 mm  
Material: Plastic+Steel  
Finish: White  
Size : 16/18 mm

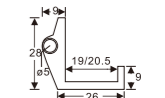

101-7



**主要材质** 锌合金  
**表面处理** 镀镍  
Material: Zinc alloy  
Finish: Nickel

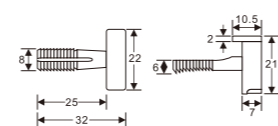

101-8



**主要材质** 锌合金+塑料  
**表面处理** 镀镍+黑色  
Material: Zinc alloy+Plastic  
Finish: Nickel+Black

102-7



**主要材质** 塑料+铁  
**表面处理** 白色/棕色/透明  
Material: Plastic+Steel  
Finish: White/Brown/  
Transparent

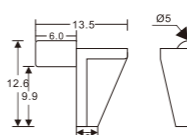

102-8



**主要材质** 塑料+铁  
**表面处理** 白色  
**产品规格** 16/18 mm  
Material: Plastic+Steel  
Finish: White  
Size : 16/18 mm

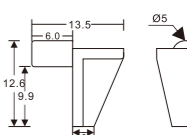

103-1



**主要材质** 塑料+铁  
**表面处理** 镀锌+灰色  
**产品规格** 6x16 mm  
Material: Plastic+Steel  
Finish: Zinc + Grey  
Size: 6x16 mm

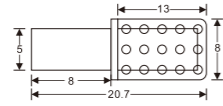

103-2



**主要材质** 塑料+铁  
**表面处理** 镀锌+灰色  
**产品规格** 6x16 mm  
Material: Plastic+Steel  
Finish: Zinc + Grey  
Size: 6x16 mm

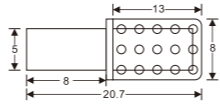

104-1



**主要材质** 锌合金  
**表面处理** 镀镍  
Material: Zinc alloy  
Finish: Nickel

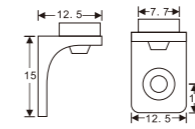

104-2



**主要材质** 塑料+铁  
**表面处理** 透明  
**产品规格** 5/6 mm  
Material: Plastic+Steel  
Finish: Transparent  
Size: 5/6 mm

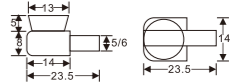

103-3



**主要材质** 铁  
**表面处理** 镀镍  
**产品规格** 5x16 mm  
Material: Steel  
Finish: Nickel  
Size: 5x16 mm

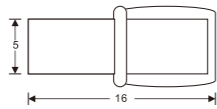

103-4



**主要材质** 铁  
**表面处理** 镀镍  
**产品规格** 8x18/23/30/  
9x18/23 mm  
Material: Steel  
Finish: Nickel  
Size: 8x18/23/30/9x18/23 mm

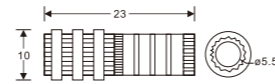

5000 个/箱  
5000 pcs/ctn

104-3



**主要材质** 塑料+铁  
**表面处理** 透明  
**产品规格** 5/6 mm  
Material: Plastic+Steel  
Finish: Transparent  
Size: 5/6 mm

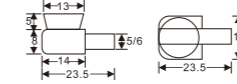

104-4



**主要材质** 塑料+铁  
**表面处理** 透明  
**产品规格** 5/6 mm  
Material: Plastic+Steel  
Finish: Transparent  
Size: 5/6 mm

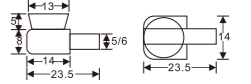

103-5



**主要材质** 铁  
**表面处理** 镀镍、镀锌  
**产品规格** 5x16/20 mm  
6x17/20 mm  
Material: Steel  
Finish: Nickel, Zinc  
Size: 5x16/20 mm  
6x17/20 mm

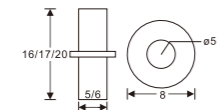

103-6



**主要材质** 铁  
**表面处理** 镀镍、镀锌  
**产品规格** 5x16/20 mm  
6x17/20 mm  
Material: Steel  
Finish: Nickel, Zinc  
Size: 5x16/20 mm  
6x17/20 mm

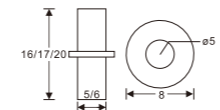

104-5



**主要材质** 铁  
**表面处理** 镀镍  
Material: Steel  
Finish: Nickel

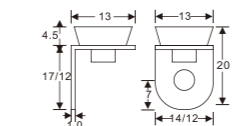

104-6



**主要材质** 铁  
**表面处理** 镀镍  
Material: Steel  
Finish: Nickel

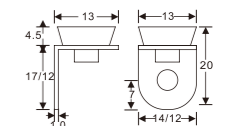

103-7



**主要材质** 塑料+铁  
**表面处理** 白色  
**产品规格** 5 mm  
Material: Plastic+Steel  
Finish: White  
Size: 5 mm

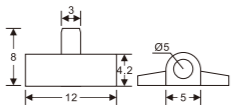

103-8



**主要材质** 塑料+铁  
**表面处理** 透明  
**产品规格** 5 mm  
Material: Plastic+Steel  
Finish: Transparent  
Size: 5 mm

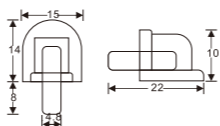

104-7



**主要材质** 铁  
**表面处理** 镀镍  
**产品规格** 5 mm  
Material: Steel  
Finish: Nickel  
Size: 5 mm

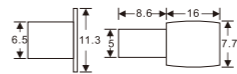

104-8



**主要材质** 铁  
**表面处理** 镀镍  
**产品规格** 5 mm  
Material: Steel  
Finish: Nickel  
Size: 5 mm

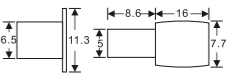

105-1



**主要材质** 锌合金  
**表面处理** 光铬/拉丝镍  
**产品规格** 84x28 / 100x28 mm  
Material: Zinc alloy  
Finish: Chrome / Satin nickel  
Size: 84 / 100x28 mm

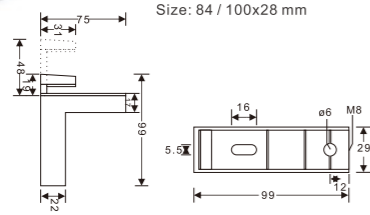

105-2



**主要材质** 锌合金  
**表面处理** 光铬/拉丝镍  
**产品规格** 51x25 / 57x28 mm  
Material: Zinc alloy  
Finish: Chrome / Satin nickel  
Size: 51x25 / 57x28 mm

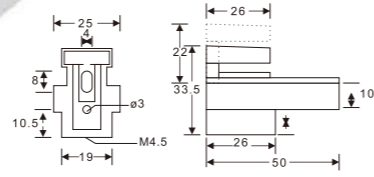

106-1



**主要材质** 锌合金  
**表面处理** 光铬/拉丝  
**适用厚度** 8/10/12 mm  
Material: Zinc Alloy  
Finish: Chrome/Satin  
Suitable thickness: 8/10/12 mm

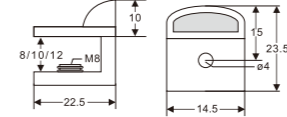

106-2



**主要材质** 锌合金  
**表面处理** 哑光/拉丝镍  
**适用厚度** 10/12/14 mm  
Material: Zinc Alloy  
Finish: Chrome / Nickel Satin  
Suitable thickness: 10/12/14 mm

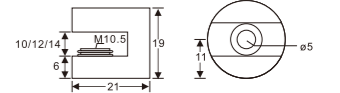

105-3



**主要材质** 锌合金  
**表面处理** 光铬/拉丝镍  
**适用厚度** 3-20 / 5-30 / 8-40 mm  
Material: Zinc alloy  
Finish: Chrome / Satin nickel  
Suitable thickness: 3-20 / 5-30 / 8-40 mm

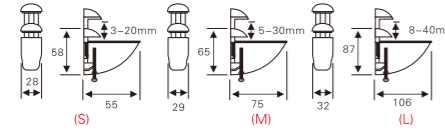

105-4



**主要材质** 锌合金  
**表面处理** 光铬/拉丝镍  
**适用厚度** 3-20 / 5-30 / 8-40 mm  
Material: Zinc alloy  
Finish: Chrome / Satin nickel  
Suitable thickness: 3-20 / 5-30 / 8-40 mm

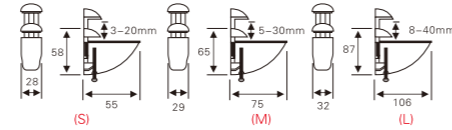

106-3



**主要材质** 锌合金  
**表面处理** 哑光/拉丝  
**适用厚度** 8 mm  
Material: Zinc Alloy  
Finish: Chrome/Satin  
Suitable thickness: 8 mm

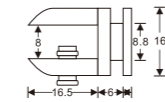

106-4



**主要材质** 锌合金  
**表面处理** 哑光/拉丝  
**适用厚度** 8 mm  
Material: Zinc Alloy  
Finish: Chrome/Satin  
Suitable thickness: 8 mm

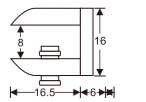

105-5



**主要材质** 锌合金  
**表面处理** 哑光/拉丝  
**门板厚度** 10/12mm  
Material: Zinc Alloy  
Finish: Matt / Satin  
Suitable thickness: 10/12mm

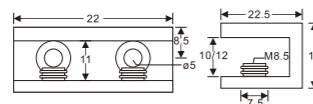

105-6



**主要材质** 锌合金  
**表面处理** 哑光/拉丝  
**门板厚度** 10/12mm  
Material: Zinc Alloy  
Finish: Matt / Satin  
Suitable thickness: 10/12mm

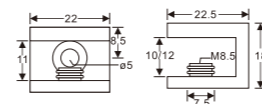

106-5



**主要材质** 锌合金  
**表面处理** 光铬/镀镍  
**适用厚度** 8 mm  
Material: Zinc Alloy  
Finish: Chrome/Nickel  
Suitable thickness: 8/10 mm

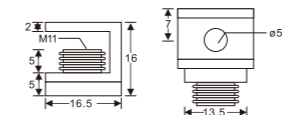

106-6



**主要材质** 锌合金  
**表面处理** 光铬/镀镍  
**适用厚度** 8 mm  
Material: Zinc Alloy  
Finish: Chrome/Nickel  
Suitable thickness: 8 mm

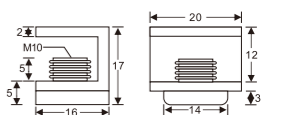

105-7



**主要材质** 锌合金  
**表面处理** 哑光/拉丝  
**适用厚度** 8/12 mm  
Material: Zinc Alloy  
Finish: Matt / Satin  
Suitable thickness: 8/12 mm

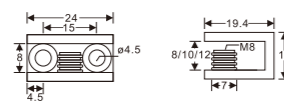

105-8



**主要材质** 锌合金  
**表面处理** 哑光/拉丝  
**适用厚度** 8/12 mm  
Material: Zinc Alloy  
Finish: Matt / Satin  
Suitable thickness: 8/12 mm

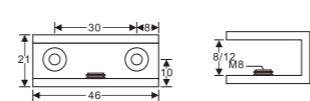

106-7



**主要材质** 锌合金  
**表面处理** 镀镍  
**适用厚度** 8/10 mm  
Material: Zinc Alloy  
Finish: Nickel  
Suitable thickness: 8/10 mm

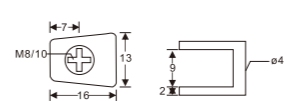

106-8



**主要材质** 锌合金  
**表面处理** 镀镍/镀铬  
**适用厚度** 5 mm  
Material: Zinc Alloy  
Finish: Nickel/Chrome  
Suitable thickness: 5 mm

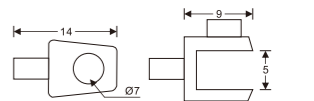

精工品质，匠心工艺  
精致您的生活。

Finish quality, Ingenious craft  
Refined your life.



配件系列  
FITTING SERIES



钻石品质 服务一流 时尚外观

配件系列 Fitting series

配件系列

109-1 P109	109-2 P109	110-1 P110	110-2 P110	110-3 P110	110-4 P110	110-5 P110	110-6 P110	110-7 P110
110-8 P110	111-1 P111	111-2 P111	111-3 P111	111-4 P111	111-5 P111	111-6 P111	111-7 P111	111-8 P111
112-1 P112	112-2 P112	112-3 P112	112-4 P112	112-5 P112	112-6 P112	112-7 P112	113-1 P113	113-2 P113
113-3 P113	113-4 P113	113-5 P113	113-6 P113	113-7 P113	113-8 P113	114-1 P114	114-2 P114	114-3 P114
114-4 P114	114-5 P114	114-6 P114	114-7 P114	114-8 P114	115-1 P115	115-2 P115	115-3 P115	115-4 P115
115-5 P115	115-6 P115	115-7 P115	115-8 P115	116-1 P116	116-2 P116	116-3 P116	116-4 P116	116-5 P116
116-6 P116	116-7 P116	116-8 P116	117-1 P117	117-2 P117	117-3 P117	117-4 P117	117-5 P117	117-6 P117
117-7 P117	117-8 P117	118-1 P118	118-2 P118	118-3 P118	118-4 P118	118-5 P118	118-6 P118	118-7 P118
118-8 P118	119-1 P119	119-2 P119	119-3 P119	119-4 P119	119-5 P119	119-6 P119	119-7 P119	119-8 P119
120-1 P120	120-2 P120	120-3 P120	120-4 P120	120-5 P120	120-6 P120	120-7 P120	120-8 P120	120-9 P120

配件系列  
Fitting series

配件系列



109-1



**主要材质** 锌合金+铁  
**表面处理** 镀铬/镀金/镀镍  
Material: Zinc alloy+Iron  
Finish: Chrome/Gold/Nickel

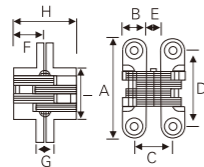

109-2



**主要材质** 锌合金+铁  
**表面处理** 镀铬/镀金/镀镍  
Material: Zinc alloy+Iron  
Finish: Chrome/Gold/Nickel

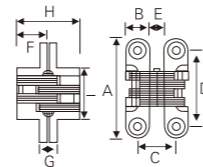

110-1



**主要材质** 锌合金+铁  
**表面处理** 镀铬/镀金/镀镍  
Material: Zinc alloy+Iron  
Finish: Chrome/Gold/Nickel

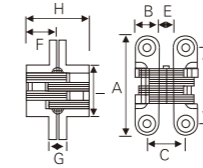

110-2



**主要材质** 锌合金  
**表面处理** 镀金/镀铬  
Material: Zinc alloy  
Finish: Golden/Chrome

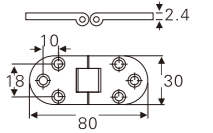

110-3



**主要材质** 锌合金  
**表面处理** 镀镍  
Material: Zinc alloy  
Finish: Nickel

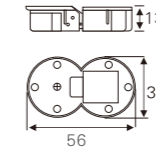

110-4



**主要材质** 锌合金  
**表面处理** 镀镍  
Material: Zinc alloy  
Finish: Nickel

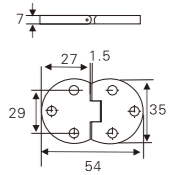

110-5



**主要材质** 锌合金  
**表面处理** 镀金/镀铬  
Material: Zinc alloy  
Finish: Golden/Chrome

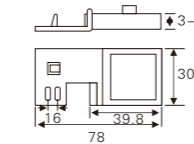

110-6



**主要材质** 铁+塑料  
**表面处理** 白色  
Material: Steel+plastic  
Finish: White

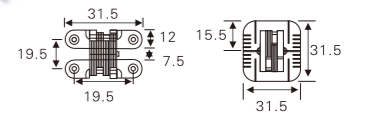

110-7



**主要材质** 锌合金  
**表面处理** 镀镍  
Material: Zinc alloy  
Finish: Nickel

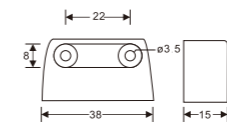

110-8



**主要材质** 塑料+铁  
**表面处理** 白色/棕色/黑色/灰色  
Material: Plastic + Steel  
Finish: White/Brown/Black/Gre

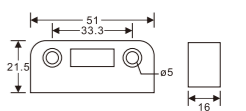

111-1



**主要材质** 塑料+锌合金  
**表面处理** 白/棕/黑/灰色  
Material: Plastic+Zinc alloy  
Finish: White/Brown/Black/Grey

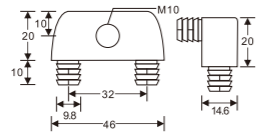

111-2



**主要材质** 锌合金  
**表面处理** 镀锌/镀镍  
Material: Zinc alloy  
Finish: Zinc / Nickel

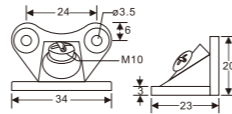

111-3



**主要材质** 塑料  
**表面处理** 黑色  
Material: Plastic  
Finish: Black

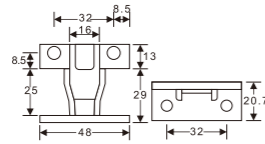

111-4



**主要材质** 铁+塑料  
**表面处理** 透明  
Material: Steel + Plastic  
Finish: Transparents

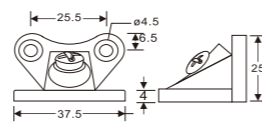

111-5



**主要材质** 塑料  
**表面处理** 镀镍  
Material: Plastic  
Finish: Nickel

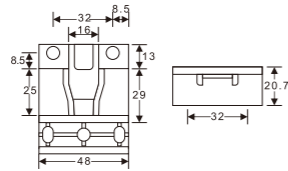

111-6



**主要材质** 不锈钢  
**表面处理** 镀镍  
Material: Stainless steel  
Finish: Nickel

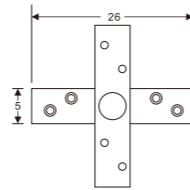

111-7



**主要材质** 锌合金  
**表面处理** 镀金  
Material: Zinc alloy  
Finish: Gold

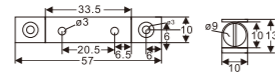

111-8



**主要材质** 锌合金  
**表面处理** 镀镍  
Material: Zinc alloy  
Finish: Nickel

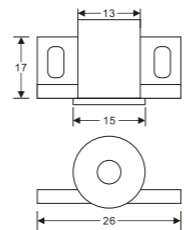

112-1



**主要材质** 塑料  
**表面处理** 白色/透明  
**产品规格** 16/18 mm  
Material: Plastic  
Finish: White / Transparent  
Size: 16/18 mm

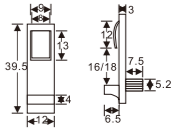

112-2



**主要材质** 塑料  
**表面处理** 白色/透明  
Material: Plastic  
Finish: White / Transparent

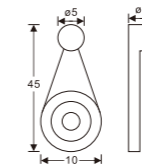

112-3



**主要材质** PP尼龙  
**表面处理** 白色  
**产品规格** 16/18 mm  
Material: Plastic  
Finish: White  
Size: 16/18 mm

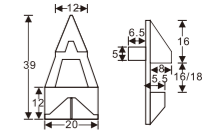

112-4



**主要材质** 塑料  
**表面处理** 白色/棕色  
Material: Plastic  
Finish: White/Brown

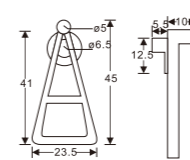

112-5



**主要材质** 塑料  
**表面处理** 白色/棕色  
Material: Plastic  
Finish: White/Brown

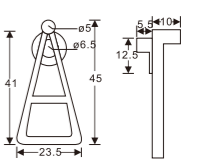

112-6



**主要材质** 塑料  
**表面处理** 透明/白色  
Material: Plastic  
Finish: White/Transparent

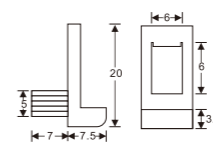

112-7



**主要材质** 塑料  
**表面处理** 透明/白色  
**产品规格** 16/18 mm  
Material: Plastic  
Finish: White/Transparent  
Size: 16/18 mm

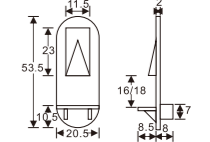

113-1



主要材质 塑料  
表面处理 米黄  
Material: Plastic  
Finish: Cream

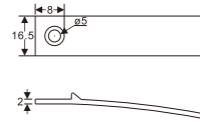

113-2



主要材质 塑料  
表面处理 棕色  
Material: Plastic  
Finish: Brown

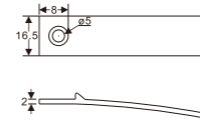

114-1



主要材质 塑料  
表面处理 白色  
Material: Plastic  
Finish: White

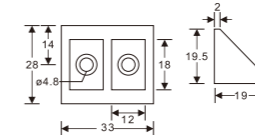

114-2



主要材质 塑料  
表面处理 白色  
Material: Plastic  
Finish: White

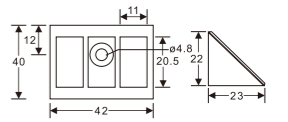

113-3



主要材质 塑料  
表面处理 白色  
Material: Plastic  
Finish: White

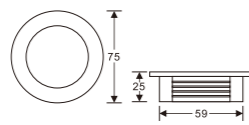

113-4



主要材质 塑料  
表面处理 白色  
Material: Plastic  
Finish: White

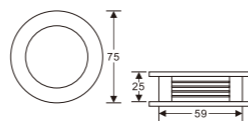

114-3



主要材质 塑料  
表面处理 白色  
Material: Plastic  
Finish: White

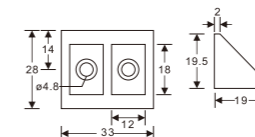

114-4



主要材质 塑料  
表面处理 棕色  
Material: Plastic  
Finish: Brown

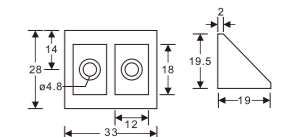

113-5



主要材质 塑料  
表面处理 白色  
产品规格 110x58x25 mm  
Material: Plastic  
Finish: White  
Size: 110x58x25 mm

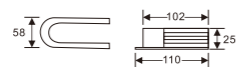

113-6



主要材质 塑料  
表面处理 白色  
Material: Plastic  
Finish: White

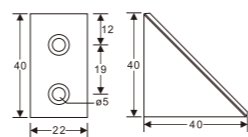

114-5



主要材质 塑料  
表面处理 白色  
Material: Plastic  
Finish: White

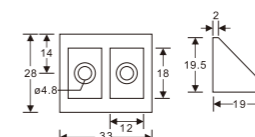

114-6



主要材质 塑料  
表面处理 白色  
Material: Plastic  
Finish: White

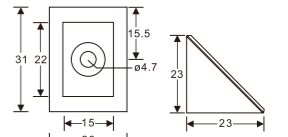

113-7



主要材质 塑料  
表面处理 白色/棕色/透明  
Material: Plastic  
Finish: White/Brown/  
Transparent

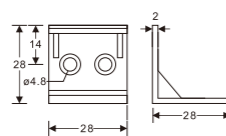

113-8



主要材质 塑料  
表面处理 白色/棕色/透明  
Material: Plastic  
Finish: White/Brown/  
Transparent

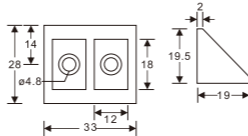

114-7



主要材质 塑料  
表面处理 白色  
Material: Plastic  
Finish: White

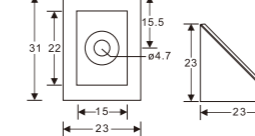

114-8



主要材质 塑料  
表面处理 白色  
Material: Plastic  
Finish: White

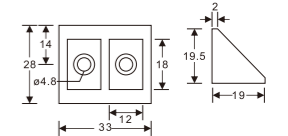





117-1



主要材质 塑料  
表面处理 透明  
Material: Plastic  
Finish: Transparent

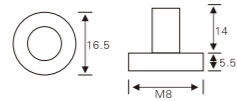

117-2



主要材质 塑料  
表面处理 白色  
Material: Plastic  
Finish: White

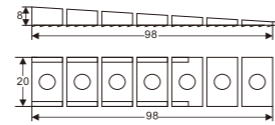

118-1



主要材质 塑料  
表面处理 白色  
Material: Plastic  
Finish: White

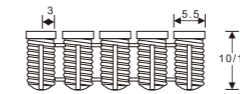

118-2



主要材质 荷木  
表面处理 原色  
Material: Schina superba  
Finish: Primary color

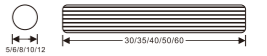

117-3



主要材质 铁+塑料  
表面处理 白色  
Material: Steel+Plastic  
Finish: White

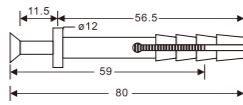

117-4



主要材质 铁+塑料  
表面处理 白色  
Material: Steel+Plastic  
Finish: White

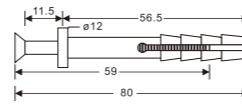

118-3



主要材质 塑料  
表面处理 灰色  
Material: Plastic  
Finish: Gray

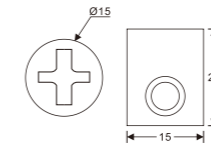

118-4



主要材质 塑料  
表面处理 米黄  
Material: Plastic  
Finish: Beige

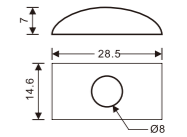

117-5



主要材质 塑料  
表面处理 灰色  
Material: Plastic  
Finish: Gray

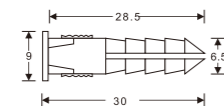

117-6



主要材质 塑料  
表面处理 灰色  
Material: Plastic  
Finish: Gray

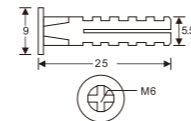

118-5



主要材质 塑料  
表面处理 透明  
Material: Plastic  
Finish: Transparent

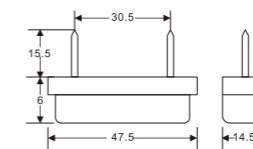

118-6



主要材质 塑料+铁  
表面处理 白色  
Material: Plastic+Steel  
Finish: White

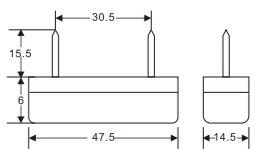

117-7



主要材质 塑料  
表面处理 白色  
Material: Plastic  
Finish: White

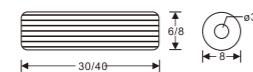

117-8



主要材质 塑料  
表面处理 棕色  
Material: Plastic  
Finish: Brown

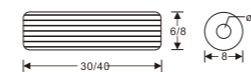

118-7



主要材质 塑料+铁  
表面处理 白色  
Material: Plastic+Steel  
Finish: White

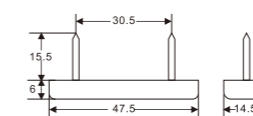

118-8



主要材质 塑料+铁  
表面处理 白色  
Material: Plastic+Steel  
Finish: White

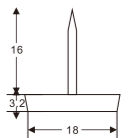

119-1



**主要材质** 塑料+铁  
**表面处理** 白色/棕色  
Material: Plastic+Steel  
Finish: White/Brown

119-2



**主要材质** 塑料+铁  
**表面处理** 白色/棕色  
Material: Plastic+Steel  
Finish: White/Brown

120-1



**主要材质** 塑料+铁  
**表面处理** 白色/黑色/棕色  
Material: Plastic + Steel  
Finish: White / Black / Brown

120-2

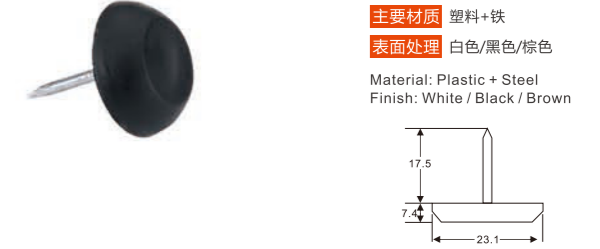

**主要材质** 塑料+铁  
**表面处理** 白色/黑色/棕色  
Material: Plastic + Steel  
Finish: White / Black / Brown

119-3



**主要材质** 塑料+铁  
**表面处理** 棕色/白色  
Material: Plastic+Steel  
Finish: Brown/White

119-4



**主要材质** 塑料  
**表面处理** 白/黑/棕/米黄色  
Material: Plastic  
Finish: White / Black / Brown / Cream

120-3



**主要材质** 塑料+铁  
**表面处理** 白色/黑色/棕色  
Material: Plastic + Steel  
Finish: White / Black / Brown

120-4



**主要材质** 塑料+铁  
**表面处理** 白色/黑色/棕色  
Material: Plastic + Steel  
Finish: White / Black / Brown

120-5



**主要材质** 塑料+铁  
**表面处理** 白色/黑色/棕色  
Material: Plastic + Steel  
Finish: White / Black / Brown

120-6



**主要材质** 塑料+铁  
**表面处理** 白色/黑色/棕色  
Material: Plastic + Steel  
Finish: White / Black / Brown

119-5



**主要材质** 塑料  
**表面处理** 白/棕/黑/米黄色/红色  
Material: Plastic  
Finish: White/Brown/Black/Yellowish/Red

119-6



**主要材质** 塑料  
**表面处理** 白/棕/黑/米黄色  
Material: Plastic  
Finish: White/Brown/Black/Yellowish

120-7



**主要材质** 塑料+铁  
**表面处理** 白色/黑色/棕色  
Material: Plastic + Steel  
Finish: White / Black / Brown

120-8



**主要材质** 塑料+铁  
**表面处理** 白色/黑色/棕色  
Material: Plastic + Steel  
Finish: White / Black / Brown

119-7



**主要材质** 塑料  
**表面处理** 白色/棕色/透明/米黄色  
**产品规格**  
Material: Plastic  
Finish: White/Brown/Transparent/Cream

119-8



**主要材质** 塑料  
**表面处理** 白色  
Material: Plastic  
Finish: White

120-9

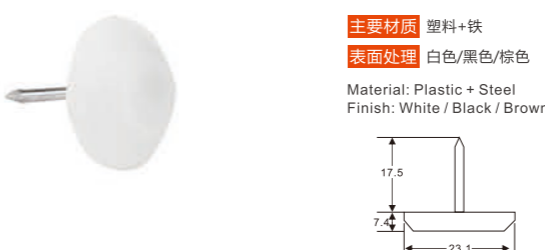

**主要材质** 塑料+铁  
**表面处理** 白色/黑色/棕色  
Material: Plastic + Steel  
Finish: White / Black / Brown

120-10

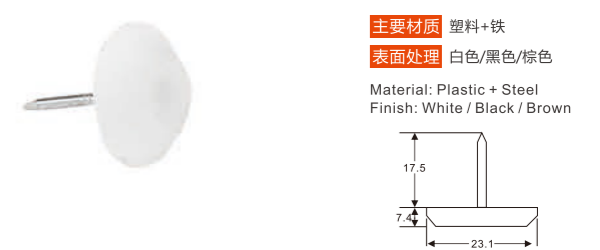

**主要材质** 塑料+铁  
**表面处理** 白色/黑色/棕色  
Material: Plastic + Steel  
Finish: White / Black / Brown

121-1



主要材质 铁  
表面处理 镀锌  
产品规格 M10/12  
Material: Steel  
Finish: Zinc  
Size: M10/12

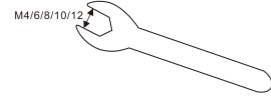

121-2



主要材质 铁  
表面处理 镀白锌/镀彩锌  
Material: Steel  
Finish: White zinc/Color Zinc

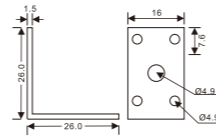

122-1

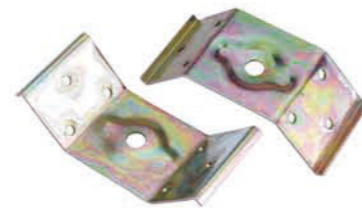

主要材质 铁  
表面处理 镀白锌/镀彩锌  
Material: Steel  
Finish: White zinc/Color Zinc

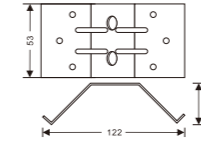

122-2



主要材质 铁  
表面处理 镀白锌/镀彩锌  
Material: Steel  
Finish: White zinc/Color Zinc

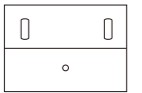

121-3



主要材质 铁  
表面处理 镀白锌/镀彩锌  
Material: Steel  
Finish: White zinc/Color Zinc

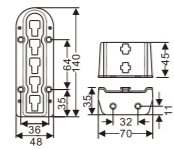

121-4



主要材质 铁  
表面处理 镀白锌/镀彩锌  
Material: Steel  
Finish: White zinc/Color Zinc

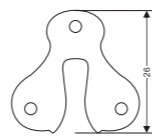

122-3



主要材质 铁  
表面处理 镀白锌/镀彩锌  
Material: Steel  
Finish: White zinc/Color Zinc

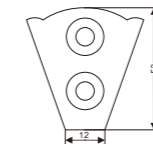

122-4



主要材质 铁  
表面处理 镀白锌/镀彩锌  
Material: Steel  
Finish: White zinc/Color Zinc

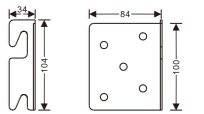

121-5



主要材质 铁  
表面处理 镀白锌/镀彩锌  
Material: Steel  
Finish: White zinc/Color Zinc

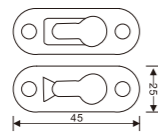

121-6



主要材质 铁  
表面处理 镀白锌/镀彩锌  
Material: Steel  
Finish: White zinc/Color Zinc

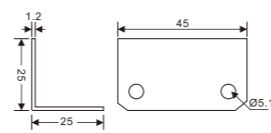

122-5



主要材质 铁  
表面处理 镀白锌/镀彩锌  
Material: Steel  
Finish: White zinc/Color Zinc

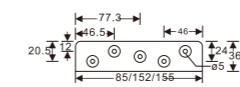

122-6



主要材质 铁  
表面处理 镀白锌/镀彩锌  
Material: Steel  
Finish: White zinc/Color Zinc

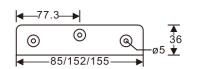

121-7



主要材质 铁  
表面处理 镀白锌/镀彩锌  
Material: Steel  
Finish: White zinc/Color Zinc

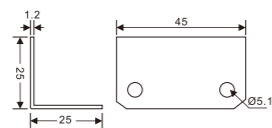

121-8



主要材质 铁  
表面处理 镀白锌/镀彩锌  
Material: Steel  
Finish: White zinc/Color Zinc

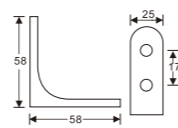

122-7



主要材质 铁  
表面处理 镀白锌/镀彩锌  
Material: Steel  
Finish: White zinc/Color Zinc

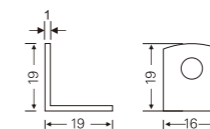

122-8



主要材质 铁  
表面处理 镀白锌/镀彩锌  
Material: Steel  
Finish: White zinc/Color Zinc

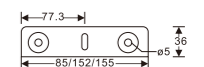

123-1



**主要材质** 铁  
**表面处理** 镀白锌/镀彩锌  
Material: Steel  
Finish: White zinc/Color Zinc

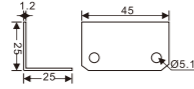

123-2



**主要材质** 铁  
**表面处理** 镀白锌/镀彩锌  
Material: Steel  
Finish: White zinc/Color Zinc

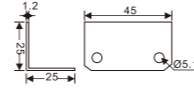

123-3



**主要材质** 铁  
**表面处理** 镀白锌/镀彩锌  
Material: Steel  
Finish: White zinc/Color Zinc

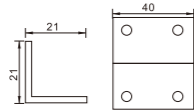

123-4



**主要材质** 铁  
**表面处理** 镀白锌/镀彩锌  
Material: Steel  
Finish: White zinc/Color Zinc

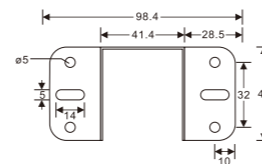

123-5



**主要材质** 铁  
**表面处理** 镀白锌/镀彩锌  
Material: Steel  
Finish: White zinc/Color Zinc

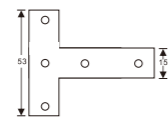

123-6



**主要材质** 铁  
**表面处理** 镀白锌/镀彩锌  
Material: Steel  
Finish: White zinc/Color Zinc

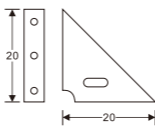

123-7



**主要材质** 铁  
**表面处理** 镀白锌/镀彩锌  
Material: Steel  
Finish: White zinc/Color Zinc

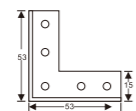

123-8



**主要材质** 铁  
**表面处理** 镀白锌/镀彩锌  
Material: Steel  
Finish: White zinc/Color Zinc

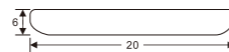

123-9



**主要材质** 铁  
**表面处理** 镀白锌/镀彩锌  
Material: Steel  
Finish: White zinc/Color Zinc

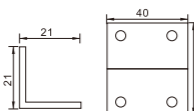

124-1

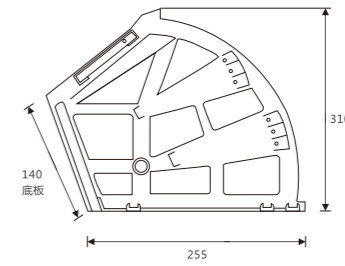

**主要材质** 铁/不锈钢  
**表面处理** 银灰/黑色/亮铬  
Material: Aluminium alloy  
Finish: Silvery Gray / Black / Bright Chromium

柜子深度建议大于32厘米(不含门板厚度),  
柜内空高度建议30-36厘米,  
中间隔板/底板厚度不能大于14mm。

124-2

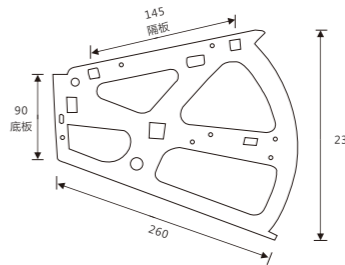

**主要材质** 铁/不锈钢  
**表面处理** 银灰/黑色/亮铬  
Material: Aluminium alloy  
Finish: Silvery Gray / Black / Bright Chromium

柜子深度建议大于25厘米(不含门板厚度),  
柜内空高度建议30-36厘米,  
中间隔板/底板厚度不能大于14mm。

124-3

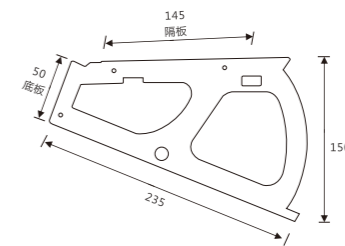

**主要材质** 铁/不锈钢  
**表面处理** 银灰/黑色/亮铬  
Material: Aluminium alloy  
Finish: Silvery Gray / Black / Bright Chromium

柜子深度建议大于15厘米(不含门板厚度),  
柜内空高度建议30-36厘米,  
中间隔板/底板厚度不能大于14mm。

125-1

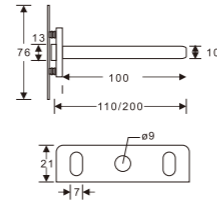

**主要材质** 铁  
**表面处理** 镀锌  
**产品规格** 110/200 mm  
 Material: Steel  
 Finish: Zinc  
 Size: 110/200 mm

125-2

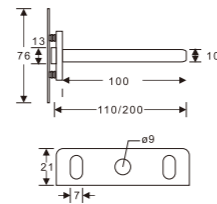

**主要材质** 铁  
**表面处理** 镀锌  
**产品规格** 110/200 mm  
 Material: Steel  
 Finish: Zinc  
 Size: 110/200 mm

125-3



**主要材质** 铁+塑料  
**表面处理** 镀锌+棕色  
**产品规格** 10×100/10×145/  
 12×120/14×140 mm  
 Material: Steel+Plastic  
 Finish: Zinc + Brown  
 Size: 10×100/10×145  
 /12×120/14×140 mm

125-4

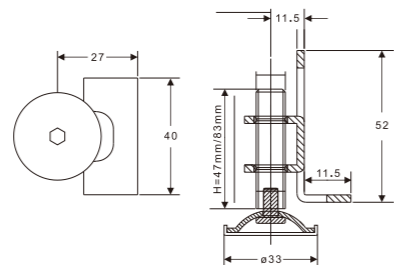

**主要材质** 铁  
**表面处理** 镀锌  
**产品规格** 80\*80mm(S)  
 80\*150mm(M)  
 80\*270mm(L)  
 Material: Steel  
 Finish: Zinc  
 Size: 80\*80mm(S)  
 80\*150mm(M)/80\*270mm(L)

简约而不失奢华，舒适却不昂贵。  
 华丽却不失温馨，简单却不繁琐。  
 出奇不意的设计，实实在在的享受。

Contracted and not comfortable but not expensive.  
 Beautiful but do not break sweet, simple but not cumbersome.  
 The design of the surprisingly unpreparedness, real enjoyment.

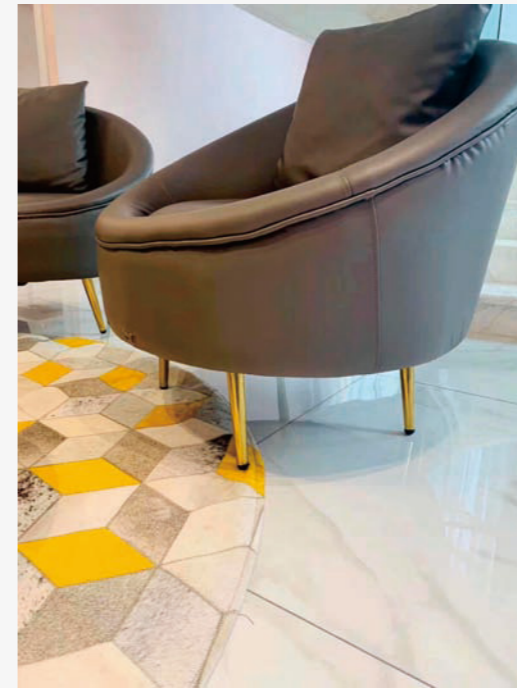

127-1



主要材质 铝合金  
表面处理 黑色  
产品规格 100/130/150/170mm

Material: Aluminum alloy  
Finish: Black  
Size: 100/130/150/170mm

127-2



主要材质 铝合金  
表面处理 黑色  
产品规格 100/130/150/170mm

Material: Aluminum alloy  
Finish: Black  
Size: 100/130/150/170mm

127-3



主要材质 铝合金  
表面处理 金色  
产品规格 100/130/150/170mm

Material: Aluminum alloy  
Finish: Gold  
Size: 100/130/150/170mm

127-4



主要材质 铝合金  
表面处理 金色  
产品规格 100/130/150/170mm

Material: Aluminum alloy  
Finish: Gold  
Size: 100/130/150/170mm

128-1



主要材质 铝合金  
表面处理 金色  
产品规格 100/120/150/170/200/250/300/350mm

Material: Aluminum alloy  
Finish: Gold  
Size: 100/120/150/170/200/250/300/350mm

128-2



主要材质 铝合金  
表面处理 金色  
产品规格 100/120/150/170/200/250/300/350mm

Material: Aluminum alloy  
Finish: Gold  
Size: 100/120/150/170/200/250/300/350mm

它的适用范围



129-1



**主要材质** 铝合金  
**表面处理** 黑色  
**产品规格** 100/120/150/170  
 200/250/300/350mm  
 Material: Aluminum alloy  
 Finish: Black  
 Size: 100/120/150/170/200/  
 250/300/350mm

129-2



**主要材质** 铝合金  
**表面处理** 金色  
**产品规格** 100/120/150/170  
 200/250/300/350mm  
 Material: Aluminum alloy  
 Finish: Gold  
 Size: 100/120/150/170/200/  
 250/300/350mm

130-1



**主要材质** 铁  
**产品规格**  $\Phi 60 \times 0.7 \times 710$  mm  
**表面处理** 光铬/白色/闪银/  
 珍珠镍/黑色/拉丝  
 Material: Steel  
 Size:  $\Phi 60 \times 0.7 \times 710$  mm  
 Finish: Chrome/White/Silver  
 /Pearl Nickel/Black/Satin

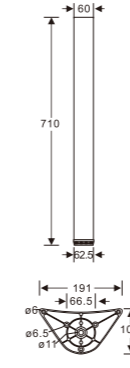

130-2



**主要材质** 铁  
**产品规格**  $\Phi 60 \times 0.7 \times 710$  mm  
**表面处理** 光铬/白色/闪银/  
 珍珠镍/黑色/拉丝  
 Material: Steel  
 Size:  $\Phi 60 \times 0.7 \times 710$  mm  
 Finish: Chrome/White/Silver  
 /Pearl Nickel/Black/Satin

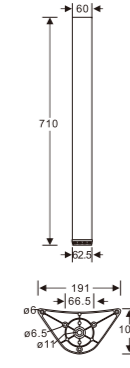

130-3



**主要材质** 铁  
**产品规格**  $\Phi 60 \times 0.7 \times 710$  mm  
**表面处理** 光铬/白色/闪银/  
 珍珠镍/黑色/拉丝  
 Material: Steel  
 Size:  $\Phi 60 \times 0.7 \times 710$  mm  
 Finish: Chrome/White/Silver  
 /Pearl Nickel/Black/Satin

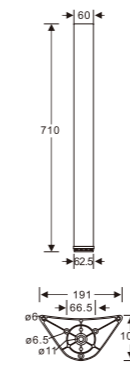

130-4



**主要材质** 铁  
**产品规格**  $\Phi 60 \times 0.7 \times 710$  mm  
**表面处理** 光铬/白色/闪银/  
 珍珠镍/黑色/拉丝  
 Material: Steel  
 Size:  $\Phi 60 \times 0.7 \times 710$  mm  
 Finish: Chrome/White/Silver  
 /Pearl Nickel/Black/Satin

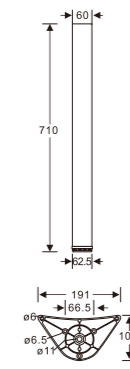

130-5



**主要材质** 铁  
**产品规格**  $\Phi 60 \times 0.7 \times 710$  mm  
**表面处理** 光铬/白色/闪银/  
 珍珠镍/黑色/拉丝  
 Material: Steel  
 Size:  $\Phi 60 \times 0.7 \times 710$  mm  
 Finish: Chrome/White/Silver  
 /Matt Nickel/Black/Satin

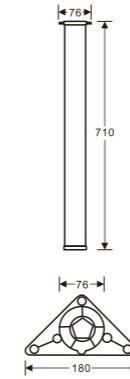

130-6



**主要材质** 铁  
**产品规格**  $\Phi 60 \times 0.7 \times 710$  mm  
**表面处理** 光铬/白色/闪银/  
 珍珠镍/黑色/拉丝  
 Material: Steel  
 Size:  $\Phi 60 \times 0.7 \times 710$  mm  
 Finish: Chrome/White/Silver  
 /Matt Nickel/Black/Satin

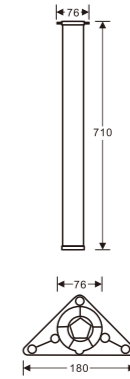



131-1



**主要材质** 锌合金  
**表面处理** 光铬/拉丝  
Material: Zinc alloy  
Finish: Chrome/Satin

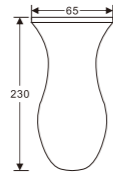

131-2



**主要材质** 锌合金  
**表面处理** 红古  
Material: Zinc alloy  
Finish: Red Bronze

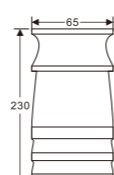

131-3



**主要材质** 铁+锌合金  
**产品规格**  $\Phi 50 \times \Phi 60 \times 215 \text{mm} - 70^\circ$   
**表面处理** 光铬/拉丝/珍珠铬  
Material: Steel + Zinc alloy  
Finish: Chrome/Satin/Pearl chrome  
Size:  $\Phi 50 \times \Phi 60 \times 215 \text{mm} - 70^\circ$

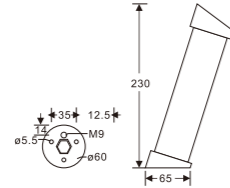

131-4



**主要材质** 铁+锌合金  
**产品规格**  $\Phi 50 \times \Phi 60 \times 215 \text{mm} - 70^\circ$   
**表面处理** 光铬/拉丝/珍珠铬  
Material: Steel + Zinc alloy  
Finish: Chrome/Satin/Pearl chrome  
Size:  $\Phi 50 \times \Phi 60 \times 215 \text{mm} - 70^\circ$

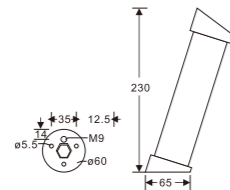

131-5



**主要材质** 铝合金  
**产品规格**  $\Phi 60 \times 0.7 \times 710 \text{mm}$   
**表面处理** 光铬/白色/闪银/珍珠镍/黑色/拉丝  
Material: Aluminium Alloy  
Size:  $\Phi 60 \times 0.7 \times 710 \text{mm}$   
Finish: Chrome/White/Silver/Pearl Nickel/Black/Satin



131-6



**主要材质** 不锈钢  
**表面处理** 光铬/砂光  
**产品规格**  $\Phi 50 \times T0.7 \text{mm}$   
**产品高度** 80/100/120 mm  
Material: Stainless Steel  
Finish: Chrome/Sandblasting  
Spec.:  $\Phi 50 \times T0.7 \text{mm}$   
Height: 80/100/120 mm

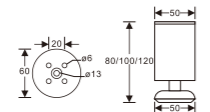

131-7



**主要材质** 不锈钢  
**表面处理** 亮光/拉丝  
**产品高度** 80/100/120/150 mm  
Material: Stainless steel  
Finish: Polishing/Satin  
Height: 80/100/120/150 mm

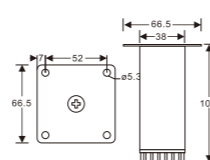

132-1



**主要材质** 不锈钢  
**表面处理** 亮光/拉丝  
**产品高度** 80/100/120/150 mm  
Material: Stainless steel  
Finish: Polishing/Satin  
Height: 80/100/120/150 mm

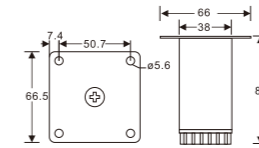

132-2



**主要材质** 铝合金  
**表面处理** 哑光  
**产品规格** 38x38 mm  
**产品高度** 80/100/120/150 mm  
Material: Aluminum Alloy  
Finish: Matt  
Size: 38x38 mm  
Height: 80/100/120/150 mm

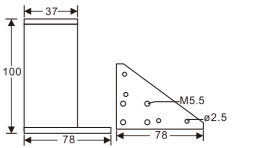

132-3



**主要材质** 铝合金  
**表面处理** 亮光/拉丝  
**产品高度** 80/100/120/150 mm  
Material: Aluminium Alloy  
Finish: Polishing/Satin  
Height: 80/100/120/150 mm

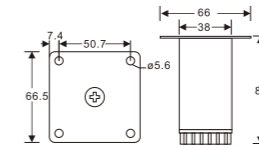

132-4



**主要材质** 铝合金  
**表面处理** 光铬/砂光  
**产品规格**  $\Phi 50 \times T0.7 \text{mm}$   
**产品高度** 80/100/120 mm  
Material: Aluminium Alloy  
Finish: Chrome/Sandblasting  
Spec.:  $\Phi 50 \times T0.7 \text{mm}$   
Height: 80/100/120 mm

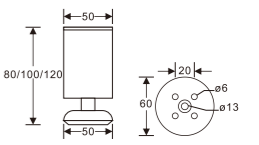

132-5



**主要材质** 不锈钢  
**表面处理** 亮光/拉丝  
**产品高度** 80/100/120/150 mm  
Material: Stainless steel  
Finish: Polishing/Satin  
Height: 80/100/120/150 mm

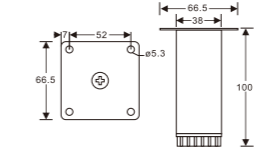

132-6



**主要材质** 不锈钢  
**表面处理** 砂光  
**产品高度** 80/100/120 mm  
Material: Stainless Steel  
Finish: Sandblasting  
Height: 80/100/120 mm

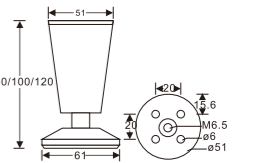

132-7



**主要材质** 不锈钢  
**表面处理** 亮光/拉丝  
**产品高度** 80/100/120/150 mm  
Material: Stainless steel  
Finish: Polishing/Satin  
Height: 80/100/120/150 mm

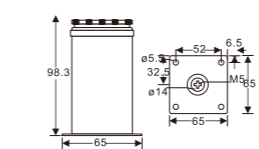

132-8



**主要材质** 不锈钢  
**表面处理** 砂光  
**产品高度** 80/100/120 mm  
Material: Stainless Steel  
Finish: Sandblasting  
Height: 80/100/120 mm

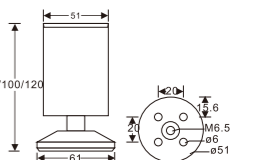

防腐防锈，超强承重；  
让你的生活随心所欲。

Anti-corrosion and anti-rust, super load bearing;  
Let your life do whatever you want.

衣管配件系列  
Railing fittings series

衣管配件系列  
RAILING FITTINGS SERIES



衣管配件系列 Railing fittings series

衣管配件系列

135-1 P135	135-2 P135	135-3 P135	135-4 P135	135-5 P135	135-6 P135	135-7 P135
135-8 P135	136-1 P136	136-2 P136	136-3 P136	136-4 P136	137-1 P137	137-2 P137
137-3 P137	137-4 P137	137-5 P137	137-6 P137	137-7 P137	137-8 P137	138-1 P138
138-2 P138	138-3 P138	138-4 P138	139-1 P139	139-2 P139	139-3 P139	139-4 P139
139-5 P139	139-6 P139	140-1 P140	140-2 P140	140-3 P140	140-4 P140	140-5 P140
141-1 P141	141-2 P141	141-3 P141	141-4 P141	141-5 P141	141-6 P141	141-7 P141
141-8 P141	142-1 P142	142-2 P142	142-3 P142	142-4 P142	142-5 P142	142-6 P142
142-7 P142						

衣管配件系列  
Railing fittings series

135-1



主要材质 锌合金  
表面处理 镀铬  
Material: Zinc alloy  
Finish: Chrome

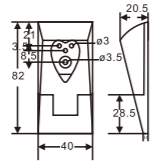

135-2



主要材质 锌合金  
表面处理 光铬  
Material: Zinc alloy  
Finish: Chrome

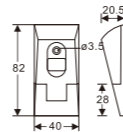

136-1



主要材质 锌合金  
表面处理 镀铬  
Material: Zinc alloy  
Finish: Chrome

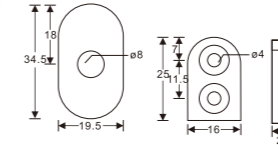

136-2



主要材质 锌合金  
表面处理 金色  
Material: Zinc alloy  
Finish: Gold

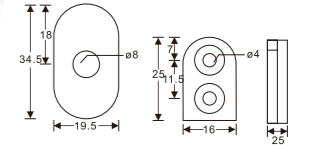

135-3



主要材质 锌合金  
表面处理 金色  
Material: Zinc alloy  
Finish: Gold

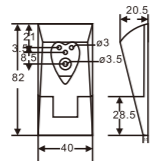

135-4



主要材质 锌合金  
表面处理 红古  
Material: Zinc alloy  
Finish: Red antique

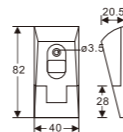

136-3



主要材质 锌合金  
表面处理 红古  
Material: Zinc alloy  
Finish: Red antique

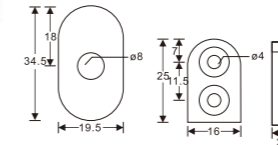

136-4



主要材质 锌合金  
表面处理 青古  
Material: Zinc alloy  
Finish: Bronze

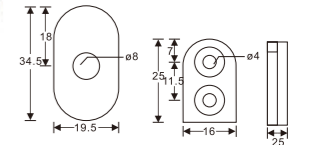

135-5



主要材质 锌合金  
表面处理 青古  
Material: Zinc alloy  
Finish: Bronze

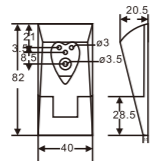

135-6



主要材质 锌合金  
表面处理 青古  
Material: Zinc alloy  
Finish: Bronze

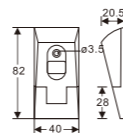

135-7



主要材质 ABS  
表面处理 金色  
Material: ABS  
Finish: Gold

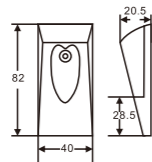

135-8



主要材质 ABS  
表面处理 金色  
Material: ABS  
Finish: Gold

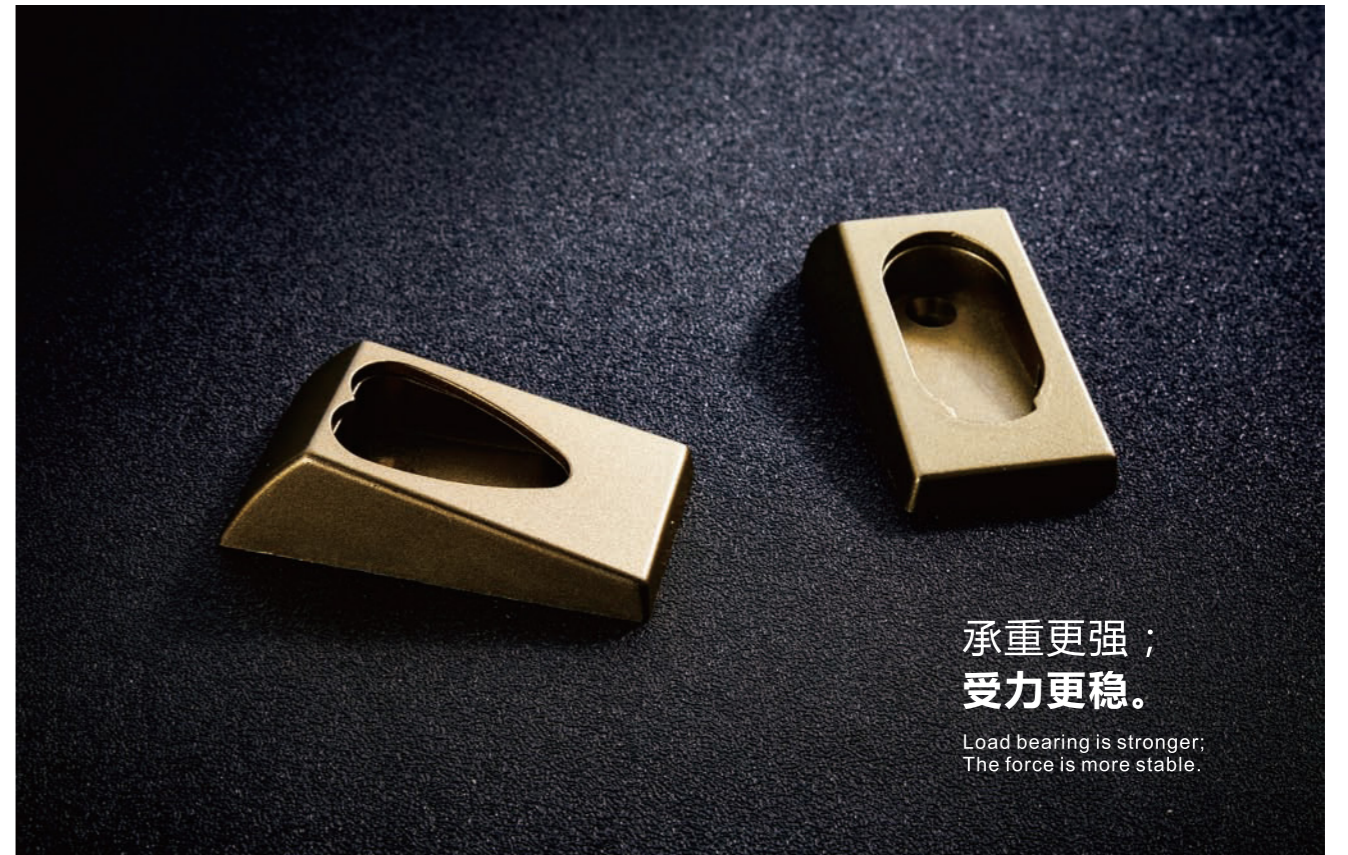
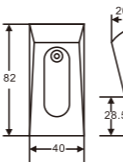

承重更强；  
受力更稳。

Load bearing is stronger;  
The force is more stable.

137-1



**主要材质** 锌合金  
**表面处理** 镀铬  
Material: Zinc alloy  
Finish: Chrome

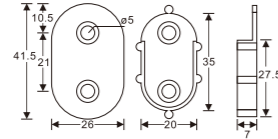

137-2



**主要材质** 锌合金  
**表面处理** 白色  
Material: Zinc alloy  
Finish: White

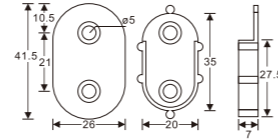

138-1



**主要材质** 塑料  
**表面处理** 白+银  
Material: Plastic  
Finish: White + Silver

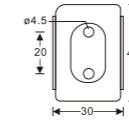

138-2



**主要材质** 塑料  
**表面处理** 灰色  
Material: Plastic  
Finish: Gray

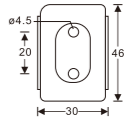

137-3



**主要材质** 锌合金  
**表面处理** 青古  
Material: Zinc alloy  
Finish: Bronze

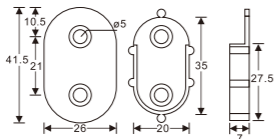

137-4



**主要材质** 塑料  
**表面处理** 灰色  
Material: Plastic  
Finish: Gray

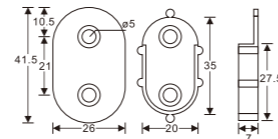

138-3



**主要材质** 塑料  
**表面处理** 黑色  
Material: Plastic  
Finish: Black

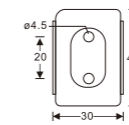

138-4



**主要材质** 塑料  
**表面处理** 白色  
Material: Plastic  
Finish: White

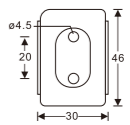

137-5



**主要材质** 塑料  
**表面处理** 红色  
Material: Plastic  
Finish: Red

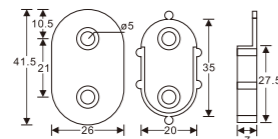

137-6



**主要材质** 塑料  
**表面处理** 白色  
Material: Plastic  
Finish: White

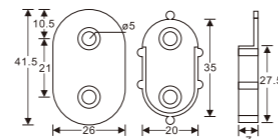

137-7



**主要材质** 塑料  
**表面处理** 黄色  
Material: Plastic  
Finish: Yellow

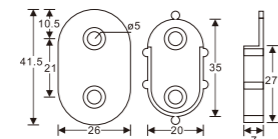

137-8



**主要材质** 塑料  
**表面处理** 黄色  
Material: Plastic  
Finish: Yellow

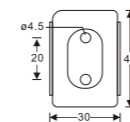

耐磨防刮；  
光滑减音。

Wear and scratch resistance;  
Smooth sound attenuation.

139-1



**主要材质** 锌合金  
**表面处理** 镀铬  
Material: Zinc alloy  
Finish: Chrome

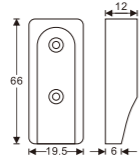

139-2



**主要材质** 锌合金  
**表面处理** 镀铬  
Material: Zinc alloy  
Finish: Chrome

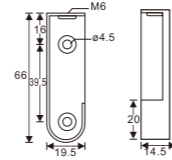

140-1



**主要材质** 锌合金  
**表面处理** 镀铬  
Material: Zinc alloy  
Finish: Chrome

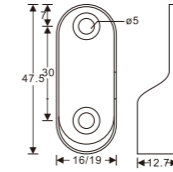

140-2



**主要材质** 锌合金  
**表面处理** 黑色  
Material: Zinc alloy  
Finish: Black

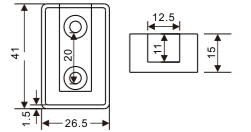

139-3



**主要材质** 锌合金  
**表面处理** 金色  
Material: Zinc alloy  
Finish: Golden

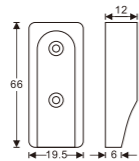

139-4



**主要材质** 锌合金  
**表面处理** 金色  
Material: Zinc alloy  
Finish: Golden

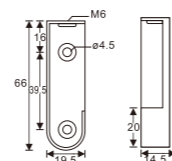

140-3



**主要材质** 锌合金  
**表面处理** 镀铬  
Material: Zinc alloy  
Finish: Chrome

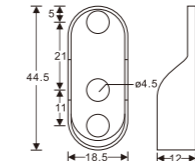

139-5



**主要材质** 锌合金  
**表面处理** 青古  
Material: Zinc alloy  
Finish: Bronze

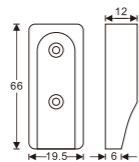

139-6



**主要材质** 锌合金  
**表面处理** 青古  
Material: Zinc alloy  
Finish: Bronze

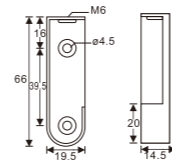

140-4



**主要材质** 锌合金  
**表面处理** 镀铬  
Material: Zinc alloy  
Finish: Chrome

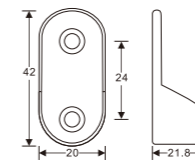

140-5



**主要材质** 塑料  
**表面处理** 米白  
Material: Plastic  
Finish: Off-white

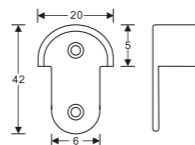

款式多变  
随意搭配

They come in all  
shapes and sizes

141-1



**主要材质** 锌合金  
**表面处理** 青古  
Material: Zinc alloy  
Finish: Bronze

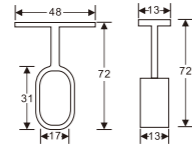

141-2



**主要材质** 锌合金  
**表面处理** 青古  
Material: Zinc alloy  
Finish: Bronze

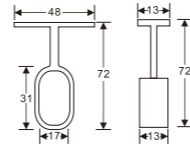

142-1



**主要材质** 锌合金  
**表面处理** 青古/金色/镀铬  
Material: Zinc alloy  
Finish: Bronze / Gold / Chrome

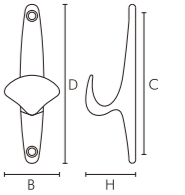

141-3



**主要材质** 锌合金  
**表面处理** 红古  
Material: Zinc alloy  
Finish: Red ancient

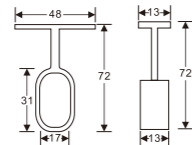

141-4



**主要材质** 锌合金  
**表面处理** 镀铬  
Material: Zinc alloy  
Finish: Chrome

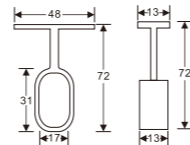

142-2



**主要材质** 锌合金  
**表面处理** 镀铬  
Material: Zinc alloy  
Finish: Chrome

142-3



**主要材质** 铁/不锈钢  
**表面处理** 镀镍  
Material: Steel/Stainless steel  
Finish: Nickel

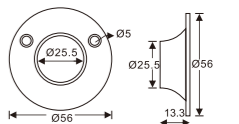

141-5



**主要材质** 锌合金  
**表面处理** 红古  
Material: Zinc alloy  
Finish: Red ancient

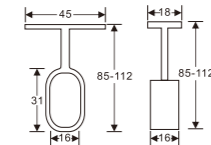

141-6



**主要材质** 锌合金  
**表面处理** 镀铬  
Material: Zinc alloy  
Finish: Chrome

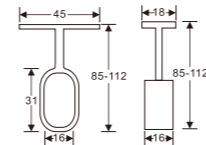

142-4



**主要材质** 锌合金  
**表面处理** 镀铬  
Material: Zinc alloy  
Finish: Chrome

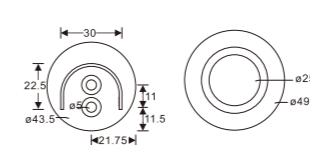

142-5



**主要材质** 锌合金  
**表面处理** 青古拉丝  
Material: Zinc alloy  
Finish: Antique bronze satin

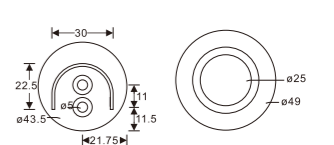

141-7



**主要材质** 锌合金  
**表面处理** 镀镍  
Material: Zinc alloy  
Finish: Nickel

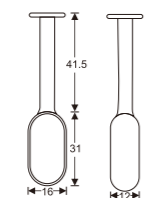

141-8



**主要材质** 锌合金  
**表面处理** 青古  
Material: Zinc alloy  
Finish: Bronze

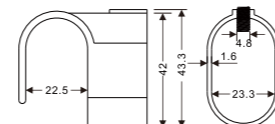

142-6



**主要材质** 锌合金  
**表面处理** 镀铬  
Material: Zinc alloy  
Finish: Chrome

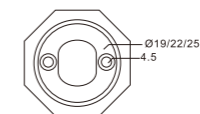

142-7



**主要材质** 锌合金  
**表面处理** 青古拉丝  
Material: Zinc alloy  
Finish: Antique bronze satin

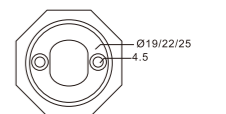

强承重  
 推拉顺滑  
 平稳静音  
 长寿命

Strong bearing  
 Push and pull, smooth  
 Smooth Mute  
 Long Life

移门轮系列  
 Sliding door wheel series

移门轮系列

SLIDING DOOR WHEEL SERIES



移门轮系列 Sliding door wheel series

移门轮



145  
P145



146  
P146



147  
P147



148  
P148



149-1  
P149



149-2  
P149



149-3  
P149



149-4  
P149



150-1  
P150



150-2  
P150



150-3  
P150



150-4  
P150



151-1  
P151



151-2  
P151



151-3  
P151



151-4  
P151



152  
P152

移门轮系列  
 Sliding door wheel series

145 移门轮



146 移门轮

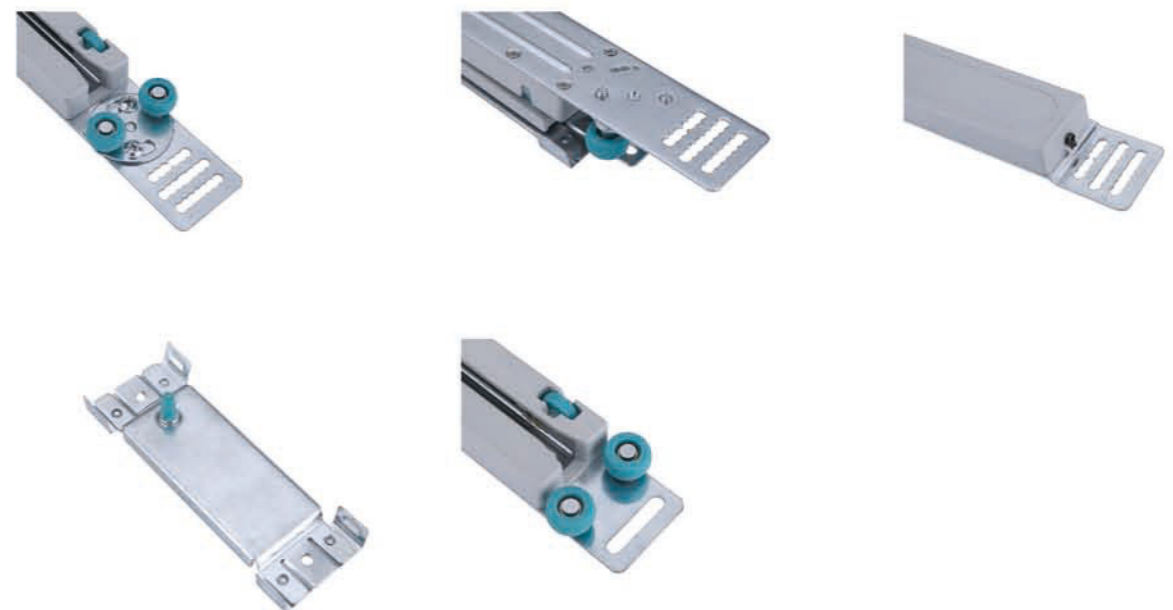



147 移门轮



148 移门轮



149-1

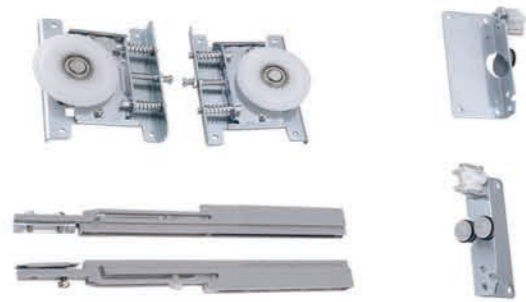

**主要材质** 铁+塑料  
**表面处理** 环保锌  
Material: Steel+Plastic  
Finish: Zinc plated

149-2

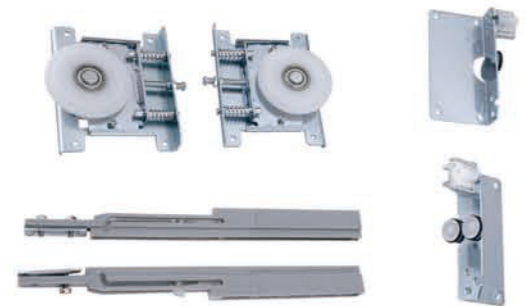

**主要材质** 铁+塑料  
**表面处理** 环保锌  
Material: Steel+Plastic  
Finish: Zinc plated

149-3

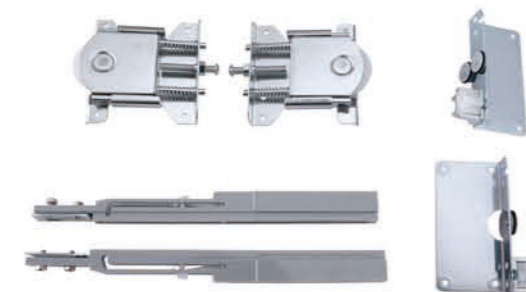

**主要材质** 铁+塑料  
**表面处理** 环保锌  
Material: Steel+Plastic  
Finish: Zinc plated

149-4

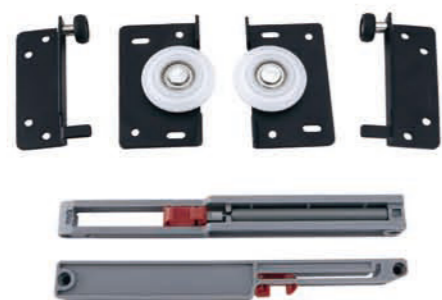

**主要材质** 铁+塑料  
**表面处理** 环保锌  
Material: Steel+Plastic  
Finish: Zinc plated

150-1

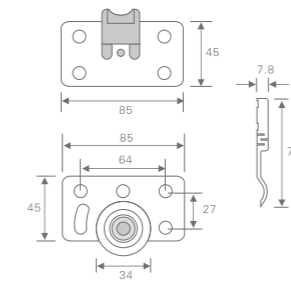
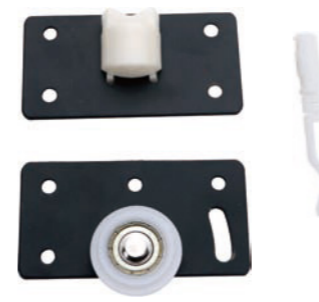

可选轨道 Optional track

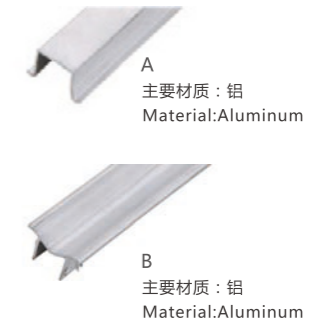

**主要材质** 铁+尼龙  
**表面处理** 黑色+白色  
**门板重量** 30 kg  
Material: Steel + Nylon  
Finish: Black + White  
Door weight: 30 kg

150-2

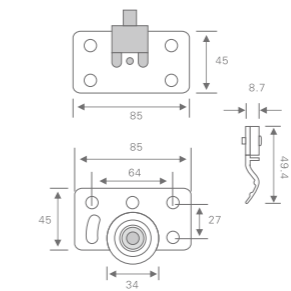

可选轨道 Optional track



**主要材质** 铁+尼龙  
**表面处理** 黑色+白色  
**门板重量** 30 kg  
Material: Steel + Nylon  
Finish: Black + White  
Door weight: 30 kg

150-3

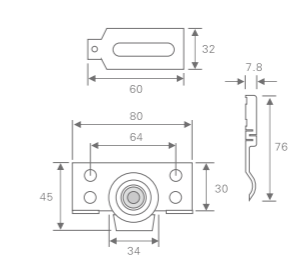

可选轨道 Optional track

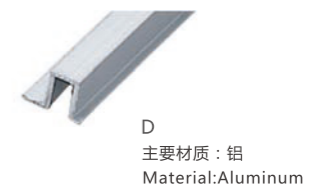

**主要材质** 铁+尼龙  
**表面处理** 银色+橙色  
**门板重量** 35 kg  
Material: Steel + Nylon  
Finish: Silver + Orange  
Door weight: 35 kg

150-4

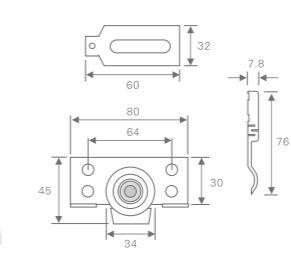

可选轨道 Optional track

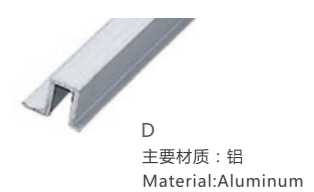

**主要材质** 铁+尼龙  
**表面处理** 黑色+白色  
**门板重量** 30 kg  
Material: Steel + Nylon  
Finish: Black + White  
Door weight: 30 kg

151-1

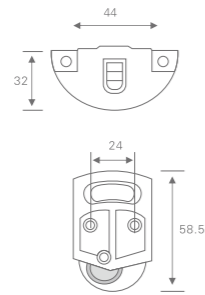

可选轨道/Optional track

G  
主要材质: PVC  
表面处理: 棕色、白色  
Material: PVC  
Finish: Brown, White

主要材质 塑料  
表面处理 棕色  
门板重量 Max. 15 kg  
Material: Plastic  
Finish: Brown  
Door weight: Max. 15 kg

151-2

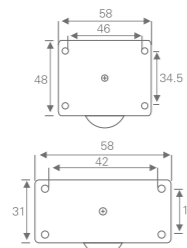

可选轨道/Optional track

G  
主要材质: PVC  
表面处理: 棕色、白色  
Material: PVC  
Finish: Brown, White

主要材质 塑料  
表面处理 棕色  
门板重量 Max. 15 kg  
Material: Plastic  
Finish: Brown  
Door weight: Max. 15 kg

151-3

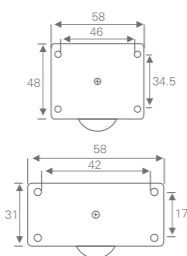

可选轨道 Optional track

A  
主要材质: 铝  
Material: Aluminum  
C  
主要材质: 铝  
Material: Aluminum

主要材质 塑料  
表面处理 黑色  
门板重量 30 kg  
Material: Plastic  
Finish: Black  
Door weight: Max. 15 kg

151-4

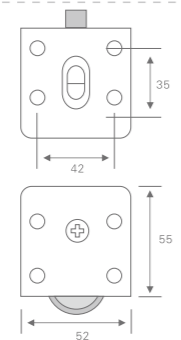

可选轨道 Optional track

A  
主要材质: 铝  
Material: Aluminum  
C  
主要材质: 铝  
Material: Aluminum

主要材质 塑料  
表面处理 黑色  
门板重量 30 kg  
Material: Plastic  
Finish: Black  
Door weight: Max. 15 kg

152 重型外挂式移门轮

主要材质 铁+塑料  
表面处理 黑色+白色  
Material: Steel + Plastic  
Finish: Black + White



零件配套表 Complete set fittings

配件 Fittings	安装方式 Installation method	3開門 for 3 doors		
		2開門 for 2 doors	3開門 for 3 doors	3開門 for 3 doors
A 内门上滚轮 Running gear for inner door		2 pcs	4 pcs	2 pcs
B 外门上滚轮 Running gear for outer door		2 pcs	2 pcs	4 pcs
C 上滚位叉 Stopper in the upper rail		4 pcs	4 pcs	4 pcs
D 上轨道 Upper double running rail		1 pc	1 pc	1 pc
E 下轨道 Down double guide rail		1 pc	1 pc	1 pc
F 内门下导架 Guide for inner door		2 pcs	4 pcs	2 pcs
G 外门下导架 Guide for outer door		2 pcs	2 pcs	4 pcs
H 下限位块 Down rail guide stopper		4 pcs	2 pcs	4 pcs

可选轨道 Optional track

E  
主要材质: 铝  
Material: Aluminum

F  
主要材质: 铝  
Material: Aluminum

轨道长度: 2/2.5/3 m  
Length: 2/2.5/3 m

优良材料  
抛磨工艺  
优雅外观

Good material  
Polishing and grinding process  
Elegant appearance

拉直器系列  
Straightener series

拉直器系列  
STRAIGHTENER SERIES



拉直器系列 Straightener series

拉直器



155  
P155



156  
P156



157  
P157



159-1  
P159



159-2  
P159

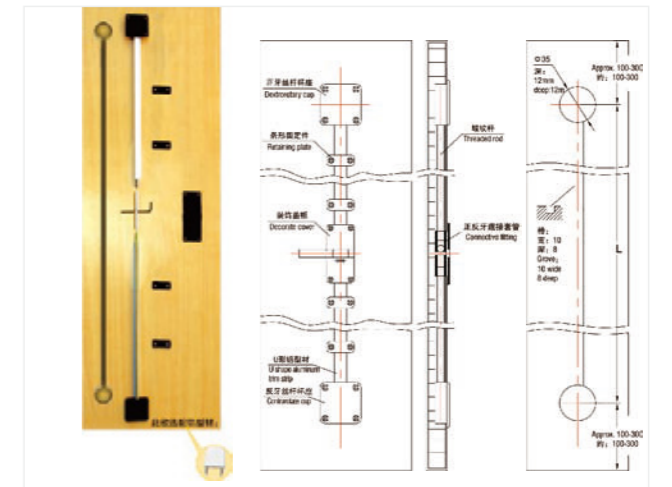

160  
P160

拉直器系列  
Straightener series

155 简约门板拉直器

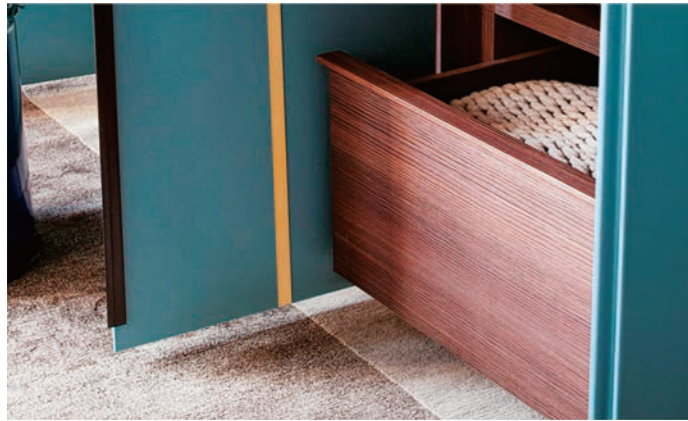

银色



土豪金



黑色

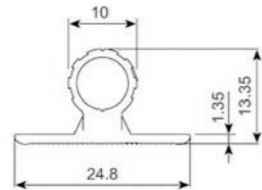

安装图 Installation drawing

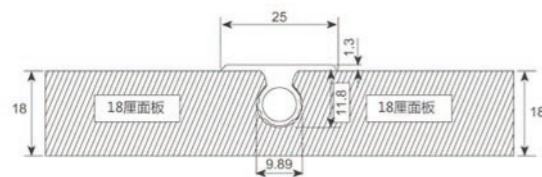

- 主要材质** 铝合金
- 表面处理** 银色、土豪金、黑色
- 配件** 六角调节扳手、开槽刀

Material: Aluminium  
Finish: Luxury gold, black, silver  
Straightener accessory:  
Hex adjustment wrench, slotting knife

156 带拉手款拉直器

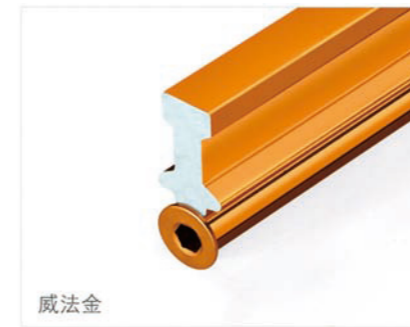
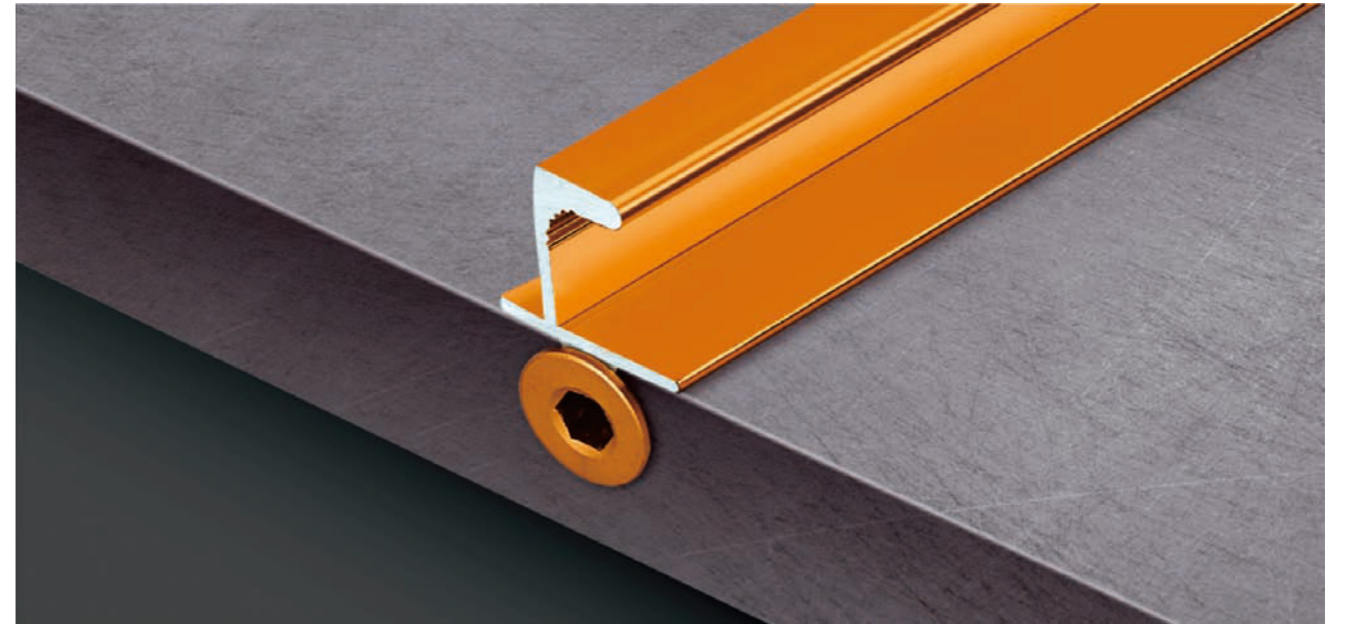

威法金

156-01



威法金

156-02

- 主要材质** 铝合金
  - 表面处理** 威法金、土豪金、高档黑、宝石灰、巧克力色
  - 配件** 六角调节扳手、开槽刀
  - 规格** 1.6m/2m/2.4m/2.8m
- Material: Aluminium  
Finish: Luxury gold, Weifa gold, High-end black, Jewelry grey, Chocolate color  
Straightener accessory:  
Hex adjustment wrench, slotting knife  
Size: 1.6m/2m/2.4m/2.8m

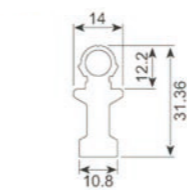

带拉手款威法拉直器-1

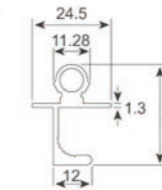

带拉手款威法拉直器-2



157 威法门板拉直器



宝石灰



土豪金



巧克力色



高档黑

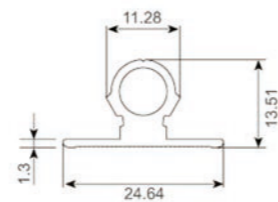

157 威法门板拉直器

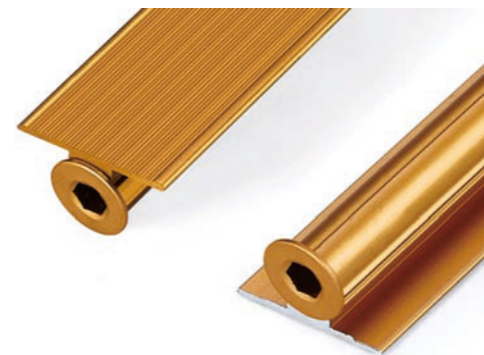

威法金

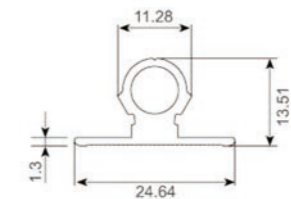

- 主要材质** 铝合金
- 表面处理** 威法金、土豪金、高档黑、宝石灰、巧克力色
- 配件** 六角调节扳手、开槽刀
- 规格** 1.6m/2m/2.4m/2.8m

Material: Aluminium  
 Finish: Luxury gold, Weifa gold,  
 High-end black, Jewelry grey,  
 Chocolate color  
 Straightener accessory:  
 Hex adjustment wrench, slotting knife  
 Size: 1.6m/2m/2.4m/2.8m

159-1 柜门拉直器

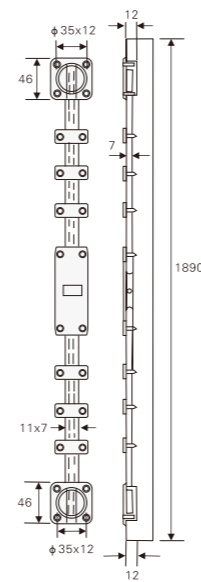

**主要材质** 铁+塑料  
**表面处理** 黑色+白色  
**产品特点** 强力防弯曲防变形  
 Material: Steel + Plastic  
 Finish: Black + White  
 Features: Strongly prevent doors from deformation

159-2 柜门拉直器

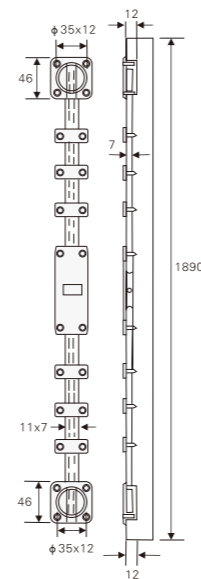

**主要材质** 锌合金+塑料  
**表面处理** 黑色+白色  
**产品特点** 强力防弯曲防变形  
 Material: Zinc alloy + Plastic  
 Finish: Black + White  
 Features: Strongly prevent doors from deformation

160 柜门拉直器

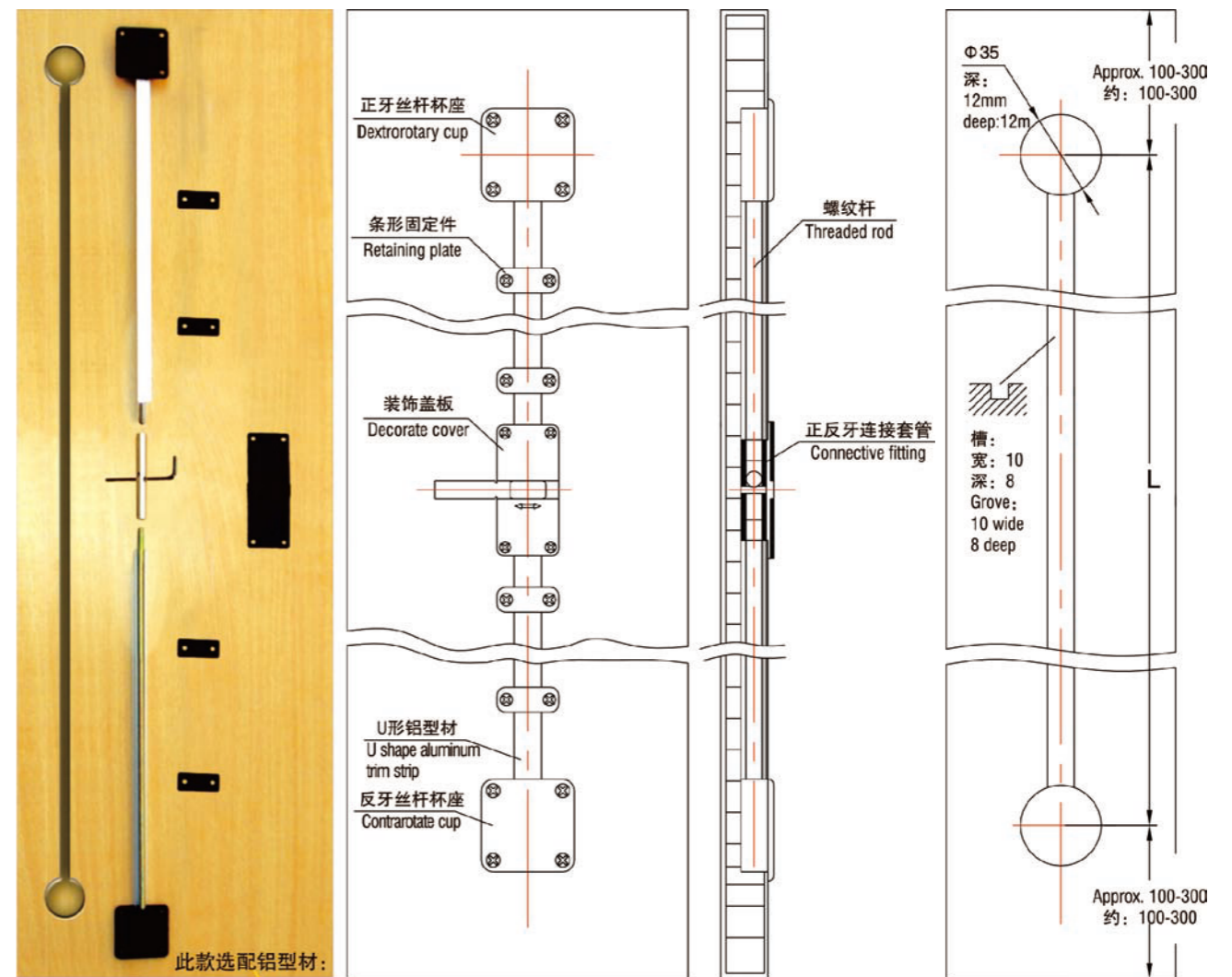

此款选配铝型材:

安装步骤:

- 1、将螺纹杆、铝型材按所需尺寸裁好。
- 2、分别把两根带有杯座的正、反牙螺纹杆按相应螺纹方向旋入连接套两端。
- 3、旋动连接套，使两端螺纹旋合长度基本相同，并调整到钻孔尺寸，然后整个嵌入门的预钻孔、槽内。
- 4、将U形铝型材盖在螺纹杆上，并嵌入门板槽内。
- 5、装上装饰盖板，均匀装上固定铝型材的塑胶条形固定件，用4c×15自攻钉压紧所有带沉孔的塑胶固定座。
- 6、用3MM内六角扳手或尖头起子拔旋连接套，直至门恢复平直状态。
- 8、关闭装饰盖板调节封口，调节工作完成。

Installation step:

1. Cut the threaded rod and the aluminum trim strip upon required dimension.
2. Screw two threaded rods with dextrorotary and the contrarotate cups into the two ends of the connective fitting respectively.
3. Screw the connective fitting to make the two ends of the same screwing length, adjust it to the drilled holes and then embed it well into the predrilled door slot.
4. Cover the U-shape aluminum trim strip onto the threaded rod and embed it into the door slot.
5. Install the decorate cover and the plastic retaining plates evenly to fix the aluminum trim strip and fasten all the plastic fixing bases with counter bores using 4×15 self-tapping screws.
6. Screw the connective fitting with a 3mm inner hexagonal wrench or screwdriver till the door is vertical.
7. Close the decorate cover.

采用优质化工原料  
灵动静音,滑动省力  
舒适随心,奢享生活。

Using high-quality chemical raw materials  
Smart mute, sliding effort  
Comfortable and enjoyable life.

办公配件系列  
Office accessories series

办公配件系列

OFFICE ACCESSORIES SERIES



钻石品质 服务一流 时尚外观

办公配件系列 Office accessories series

办公配件系列



办公配件系列  
Office accessories series



163-1

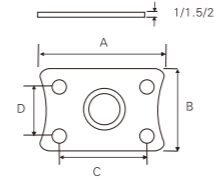

**主要材质** PP+铁  
**表面处理** 镀锌/黑色  
**产品规格** 1"/1.2"/1.25"/1.5"/2"/2.5"/3"  
**Material:** PP + Steel  
**Finish:** Zinc/Black  
**Size:** 1"/1.2"/1.25"/1.5"/2"/2.5"/3"

164-1

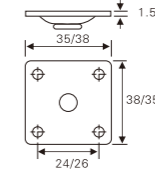

**主要材质** 铁+尼龙+锌合金  
**表面处理** 黑色  
**产品规格** 1.5/2"  
**Material:** Steel+Nylon+Zinc alloy  
**Finish:** Black  
**Size:** 1.5/2"

163-2

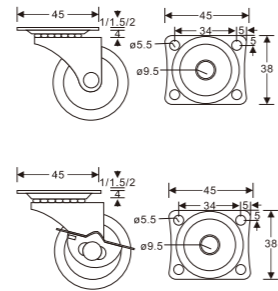

**主要材质** 铁+PU  
**表面处理** 光铬  
**产品规格** 1.5"/2"/3"  
**Material:** Steel+PU  
**Finish:** Chrome  
**Size:** 1.5"/2"/3"

164-2

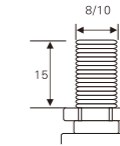

**主要材质** 铁+尼龙+锌合金  
**表面处理** 黑色  
**产品规格** 1.5/2"  
**Material:** Steel+Nylon+Zinc alloy  
**Finish:** Black  
**Size:** 1.5/2"

163-3

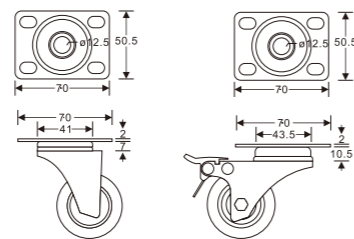

**主要材质** 铁+PU  
**表面处理** 电泳黑  
**产品规格** 1.5"/2"/2.5"/3"  
**Material:** Steel+PU  
**Finish:** Black Electrophoresis  
**Size:** 1.5"/2"/2.5"/3"

163-4

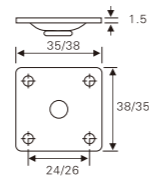

**主要材质** 铁+尼龙+锌合金  
**表面处理** 黑色  
**产品规格** 1.5/2"  
**Material:** Steel+Nylon+Zinc alloy  
**Finish:** Black  
**Size:** 1.5/2"



滚轴能使滚动更耐磨，  
 承载更高，解放你的双手。  
 让你轻松享受便捷生活。

The roller makes the rolling more wearable,  
 Carry higher, free your hands.  
 Let you easily enjoy convenient life.

165-1



165-1A

165-1B

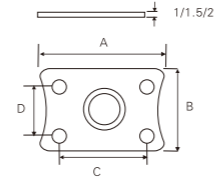

**主要材质** PP+铁  
**表面处理** 镀锌  
**产品规格** 1"/1.2"/1.25"/  
 1.5"/2"/2.5"/3"  
 Material: PP + Steel  
 Finish: Zinc  
 Size: 1"/1.2"/1.25"/  
 1.5"/2"/2.5"/3"

166-1



166-1A

166-1B

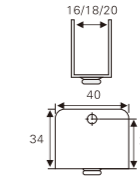

**主要材质** 铁+尼龙  
**表面处理** 黑色  
**产品规格** 1.5"/2"  
 Material: Steel + Nylon  
 Finish: Black  
 Size: 1.5"/2"

165-2



165-2A

165-2B

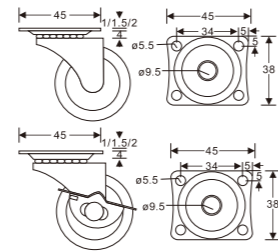

**主要材质** 铁+PP  
**表面处理** 镀锌  
**产品规格** 1"/1.2"/1.5"/2"/  
 2.5"/3"  
 Material: Steel + PP  
 Finish: Zinc  
 Size: 1"/1.2"/1.5"/2"/2.5"/3"

166-2



166-2A

166-2B

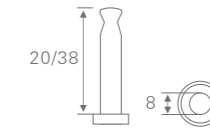

**主要材质** 铁+尼龙  
**表面处理** 黑色  
**产品规格** 1.5"/2"  
 Material: Steel + Nylon  
 Finish: Black  
 Size: 1.5"/2"

165-3



165-3A

165-3B

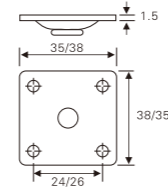

**主要材质** 铁+塑料  
**表面处理** 黑色  
**产品规格** 1.5"/2"  
 Material: Steel+Plastic  
 Size: 1.5"/2"  
 Finish: Black

166-3



166-3A

166-3B

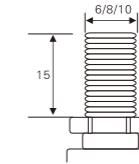

**主要材质** 铁+尼龙  
**表面处理** 黑色  
**产品规格** 1.5"/2"  
 Material: Steel + Nylon  
 Finish: Black  
 Size: 1.5"/2"

165-4



165-4A

165-4B

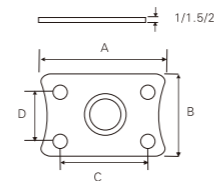

**主要材质** PP+铁  
**表面处理** 镀锌  
**产品规格** 1"/1.2"/1.25"/  
 1.5"/2"/2.5"/3"  
 Material: PP + Steel  
 Finish: Zinc  
 Size: 1"/1.2"/1.25"/  
 1.5"/2"/2.5"/3"

166-4



**主要材质** 尼龙  
**表面处理** 黑色  
 Material: Nylon  
 Finish: Black

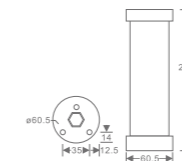

166-5



**主要材质** 尼龙  
**表面处理** 黑色  
 Material: Nylon  
 Finish: Black

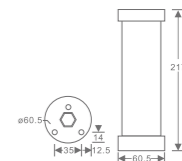

167-1



**主要材质** 塑料  
**表面处理** 沙银  
**产品规格** 780 mm

Material: Plastic  
Finish: Sand silver  
Size: 780 mm

167-2



**主要材质** 塑料  
**表面处理** 黑色  
**产品规格** 780 mm

Material: Plastic  
Finish: Black  
Size: 780 mm

167-3



**主要材质** 塑料  
**表面处理** 白色  
**产品规格** 780 mm

Material: Plastic  
Finish: White  
Size: 780 mm

167-4

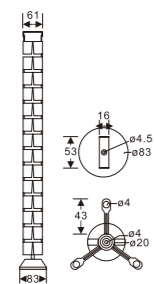

**主要材质** 塑料  
**表面处理** 沙银  
**产品规格** 780 mm

Material: Plastic  
Finish: Sand silver  
Size: 780 mm

167-5

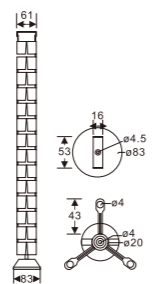

**主要材质** 塑料  
**表面处理** 黑色  
**产品规格** 780 mm

Material: Plastic  
Finish: Black  
Size: 780 mm

167-6

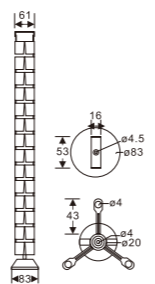

**主要材质** 塑料  
**表面处理** 白色  
**产品规格** 780 mm

Material: Plastic  
Finish: White  
Size: 780 mm

168-1

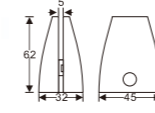

**主要材质** 锌合金  
**表面处理** 喷珠光、沙白、沙黑、光白  
Material: Zinc alloy  
Finish: Pearl silver/  
Pearl white / Pear black  
Bright white

168-2

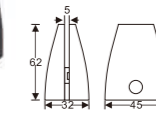

**主要材质** 锌合金  
**表面处理** 喷珠光、沙白、沙黑、光白  
Material: Zinc alloy  
Finish: Pearl silver/  
Pearl white / Pear black  
Bright white

168-3

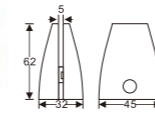

**主要材质** 锌合金  
**表面处理** 喷珠光、沙白、沙黑、光白  
Material: Zinc alloy  
Finish: Pearl silver/  
Pearl white / Pear black  
Bright white

168-4

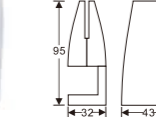

**主要材质** 锌合金  
**表面处理** 喷珠光、沙白、沙黑、光白  
Material: Zinc alloy  
Finish: Pearl silver/  
Pearl white / Pear black  
Bright white

168-5

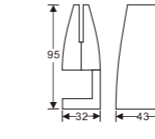

**主要材质** 锌合金  
**表面处理** 喷珠光、沙白、沙黑、光白  
Material: Zinc alloy  
Finish: Pearl silver/  
Pearl white / Pear black  
Bright white

168-6



**主要材质** 锌合金  
**表面处理** 喷珠光、沙白、沙黑、光白  
Material: Zinc alloy  
Finish: Pearl silver/  
Pearl white / Pear black  
Bright white

168-7

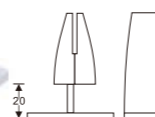

**主要材质** 锌合金  
**表面处理** 喷珠光、沙白、沙黑、光白  
Material: Zinc alloy  
Finish: Pearl silver/  
Pearl white / Pear black  
Bright white

168-8



**主要材质** 塑料  
**表面处理** 白色  
Material: Plastic  
Finish: White

168-9

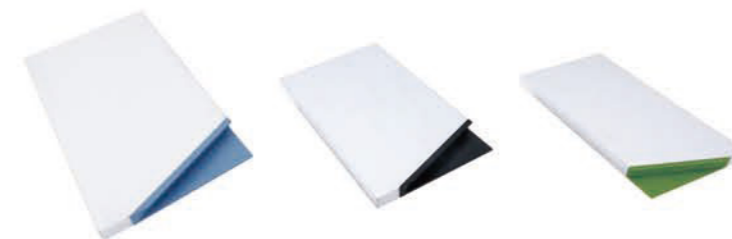

**主要材质** 塑料  
**表面处理** 白色  
Material: Plastic  
Finish: White

169-1



主要材质 铁+塑料  
表面处理 黑色+白色  
Material: Steel + Plastic  
Finish: Black + White

170-1



主要材质 木头+塑料  
表面处理 黑色/白色/红色/绿色  
Material: Wood + Plastic  
Finish: Black / White / Red / Green

169-2



主要材质 铁+塑料  
表面处理 黑色+白色  
Material: Steel + Plastic  
Finish: Black + White

170-2



主要材质 塑料  
表面处理 黑色  
Material: Plastic  
Finish: Black

169-3



主要材质 铁+塑料  
表面处理 黑色+白色  
Material: Steel + Plastic  
Finish: Black + White

170-3



主要材质 塑料  
表面处理 黑色  
Material: Plastic  
Finish: Black

169-4



主要材质 铁+塑料  
表面处理 黑色  
Material: Steel + Plastic  
Finish: Black

170-4



主要材质 塑料  
表面处理 灰色  
Material: Steel + Nylon  
Finish: Gray

171-1

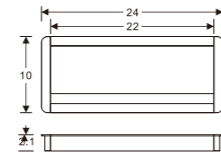

**主要材质** 铝合金+锌合金  
**表面处理** 喷白/喷黑  
**产品规格** 300x120x27 mm  
 Material: Aluminum alloy  
 Zinc Alloy  
 Finish: White/Black  
 Size: 300x120x27 mm

172-1

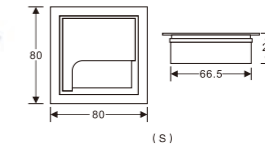

**主要材质** 铝合金  
**表面处理** 白色/黑色  
 Material: Aluminium alloy  
 Finish: White/Black

171-2

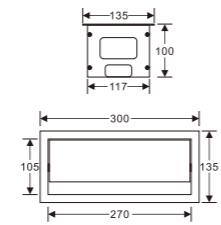

**主要材质** 铝合金  
**表面处理** 白色/黑色  
**产品规格** 300x135x100 mm  
 Material: Aluminum alloy  
 Finish: White/Black  
 Size: 300x135x100 mm

172-2

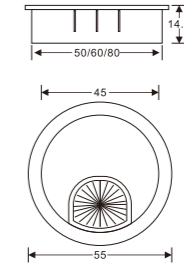

**主要材质** 塑料  
**表面处理** 沙银/黑色  
**产品规格** 50/60/80 mm  
 Material: Plastic  
 Finish: Black/Sand silver  
 Size: 50/60/80 mm

171-3

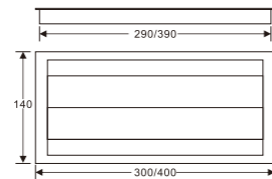

**主要材质** 铝合金  
**表面处理** 白色/黑色  
**产品规格** 140x300/140x400 mm  
 Material: Aluminum alloy  
 Finish: White/Black  
 Size: 140x300/140x400 mm

172-3

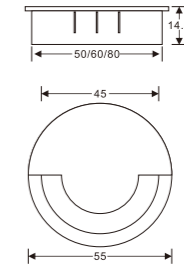

**主要材质** 塑料  
**表面处理** 沙银/蓝色  
 Material: Plastic  
 Finish: Sand silver/Blue

171-4

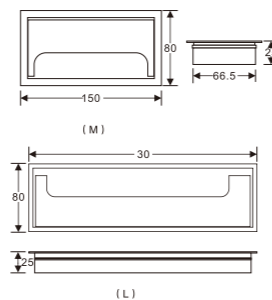

**主要材质** 铝合金  
**表面处理** 白色/黑色/银色  
**产品规格** 80x160mm  
**产品高度** 20mm  
 Material: Aluminium alloy  
 Finish: White / Black / Silver  
 Size: 80x160mm  
 Height: 20mm

172-4

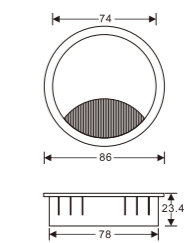
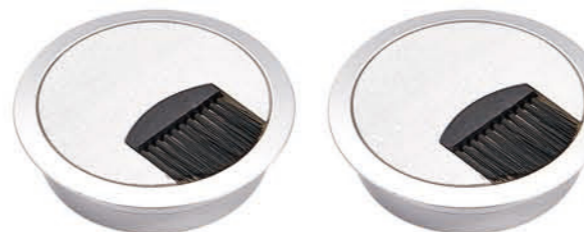

**主要材质** 塑料  
**表面处理** 沙银/白色/黑色  
 Material: Plastic  
 Finish: Silver sand / White / Black

173-1

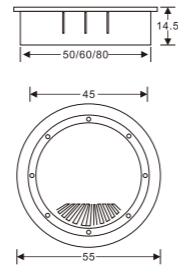

**主要材质** 塑料  
**表面处理** 黑色/灰色/白色/沙银  
Material: Plastic  
Finish: Black / Grey / White / Sand Silver

174-1

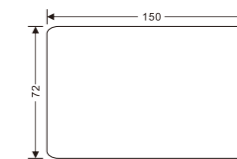

**主要材质** 塑料  
**表面处理** 黑色/灰色/白色/沙银  
Material: Plastic  
Finish: Black / Grey / White / Sand Silver

173-2

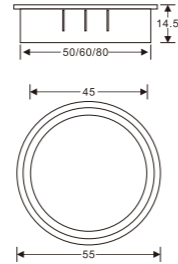

**主要材质** 塑料  
**表面处理** 黑色/灰色/白色/沙银  
Material: Plastic  
Finish: Black / Grey / White / Sand Silver

174-2

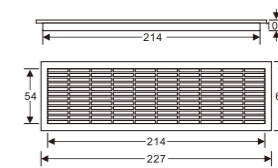

**主要材质** 塑料(ABS/PP)  
**表面处理** 沙银, 原色  
**产品规格** 227 x 68 mm  
Material: Plastic (ABS/PP)  
Finish: Sand silver / Primary  
Size: 227x68 mm

173-3

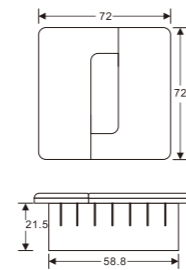

**主要材质** 塑料  
**表面处理** 沙银  
**产品规格** 60 mm  
Material: Plastic  
Finish: Sand silver  
Size: 60 mm

174-3

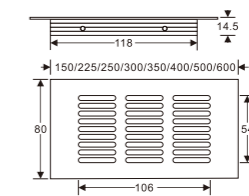

**主要材质** 铝合金  
**表面处理** 哑光/拉丝  
**产品规格** 80x150/200/225/250/300/350/400/500/600 mm  
Material: Aluminum alloy  
Finish: Matt / Satin  
Size: 80x150/200/225/250/300/350/400/500/600 mm

173-4

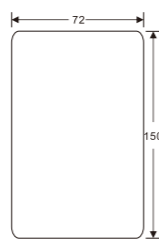

**主要材质** 塑料  
**表面处理** 黑色/灰色/白色/沙银  
Material: Plastic  
Finish: Black / Grey / White / Sand Silver

174-4



**主要材质** 不锈钢  
**表面处理** 拉丝  
**产品规格** 19/25/35/53 mm  
Material: Stainless Steel  
Finish: Satin  
Size: 19/25/35/53 mm

174-5



**主要材质** 不锈钢  
**表面处理** 拉丝  
**产品规格** 19/25/35/53 mm  
Material: Stainless Steel  
Finish: Satin  
Size: 19/25/35/53 mm

175-1



**主要材质** 不锈钢  
**表面处理** 拉丝  
**产品规格** 19/25/35/53 mm  
Material: Stainless Steel  
Finish: Satin  
Size: 19/25/35/53 mm

175-2



**主要材质** 不锈钢  
**表面处理** 拉丝  
**产品规格** 19/25/35/53 mm  
Material: Stainless Steel  
Finish: Satin  
Size: 19/25/35/53 mm

175-3

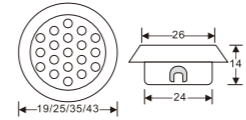

**主要材质** 不锈钢  
**表面处理** 拉丝  
**产品规格** 19/25/35/53 mm  
Material: Stainless Steel  
Finish: Satin  
Size: 19/25/35/53 mm

175-4

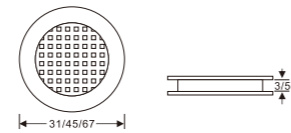

**主要材质** 塑料  
**表面处理** 白/米黄/棕色  
**产品规格** 3×31/3×45/3×67/  
5×45/5×67mm  
Material: Plastic  
Finish: White/Cream/Brown  
Size: 3×31/3×45/3×67/  
5×45/5×67mm

175-5

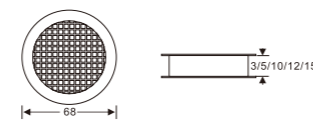

**主要材质** 塑料  
**表面处理** 白/米黄/棕色  
**产品规格** 3×68mm/5×68mm/  
/10×68mm/12×68mm/  
15×68mm  
Material: Plastic  
Finish: White/Cream/Brown  
Size: 3×68mm/5×68mm/10×68mm/  
/12×68mm/15×68mm

176-1

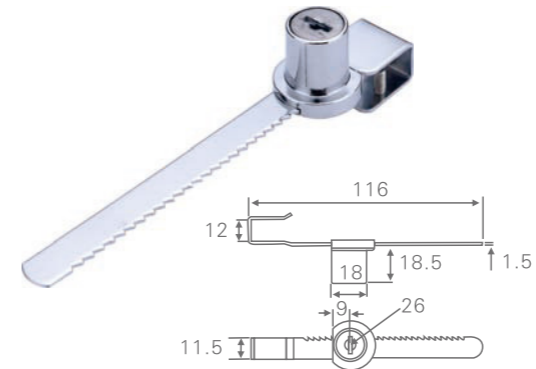

**主要材质** 锌合金  
**表面处理** 镀铬  
Material: Zinc alloy  
Finish: Chrome

176-2

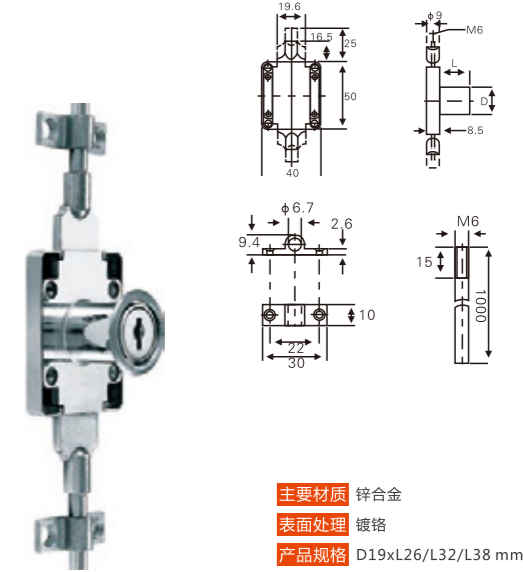

**主要材质** 锌合金  
**表面处理** 镀铬  
**产品规格** D19xL26/L32/L38 mm  
Material: Zinc alloy  
Finish: Chrome  
Size: D19xL26/L32/L38 mm

176-3

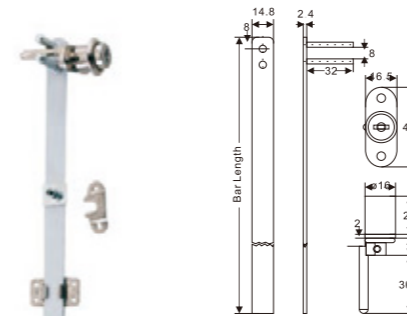

**主要材质** 锌合金  
**表面处理** 镀铬  
**产品规格** D16xL20 mm / D19xL20 mm  
**产品厚度** 1.8 mm / 2.0 mm / 2.4 mm  
Material: Zinc alloy  
Finish: Chrome  
Size : D16xL20 mm / D19xL20 mm /  
Thickness : 1.8 mm / 2.0 mm / 2.4 mm

176-4



**主要材质** 锌合金  
**表面处理** 镀铬  
**产品规格** D16xL20 mm / D19xL20 mm  
**产品厚度** 1.8 mm / 2.0 mm  
Material: Zinc alloy  
Finish: Chrome  
Size : D16xL20 mm / D19xL20 mm /  
Thickness : 1.8 mm / 2.0 mm

177-1

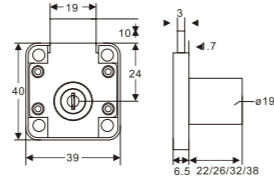

主要材质 锌合金  
表面处理 镀铬  
Material: Zinc alloy  
Finish: Chrome

178-1

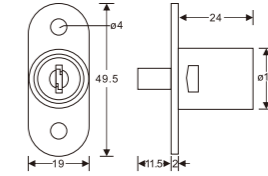

主要材质 锌合金  
表面处理 镀铬  
Material: Zinc alloy  
Finish: Chrome

177-2

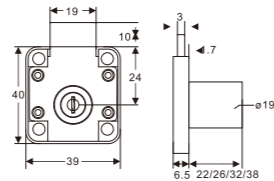

主要材质 锌合金  
表面处理 镀铬  
Material: Zinc alloy  
Finish: Chrome

178-2

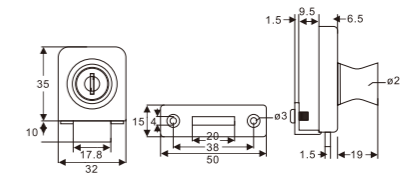

主要材质 锌合金  
表面处理 镀铬  
Material: Zinc alloy  
Finish: Chrome

177-3

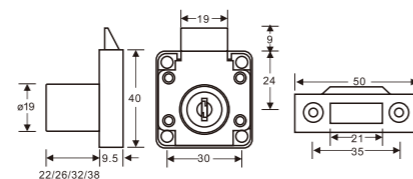

主要材质 锌合金  
表面处理 镀铬  
Material: Zinc alloy  
Finish: Chrome

178-3

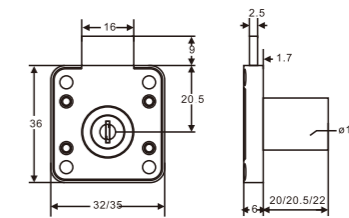

主要材质 锌合金  
表面处理 镀铬  
Material: Zinc alloy  
Finish: Chrome

177-4

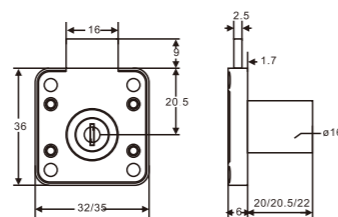

主要材质 锌合金  
表面处理 镀铬  
Material: Zinc alloy  
Finish: Chrome

178-4

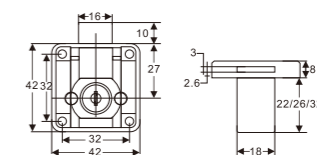

主要材质 锌合金  
表面处理 镀铬  
Material: Zinc alloy  
Finish: Chrome



具有个性的色彩和结构，  
在纷繁的世界里，  
焕发出独特的表现力，  
品质典范，唯有细节才能彰显品质。

Has the individuality color and the structure,  
in the complex world,  
coruscates the unique expressive force,  
the quality model,  
only then can reveal the quality by the detail.

功能配件系列  
Functional accessories series

功能配件系列

FUNCTIONAL ACCESSORIES SERIES



钻石品质 服务一流 时尚外观

功能配件系列 Functional accessories series

功能配件系列

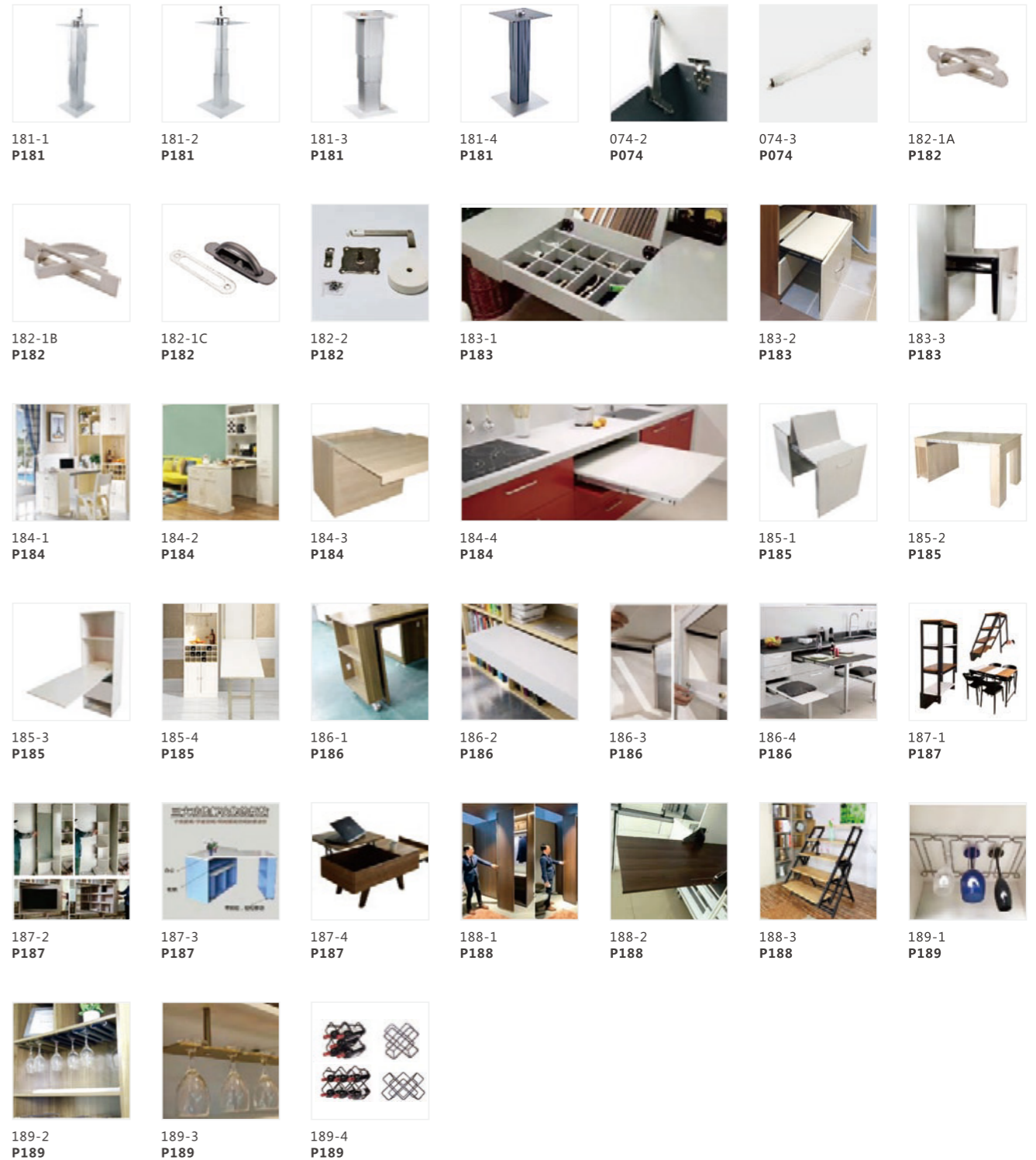

功能配件系列  
Functional accessories series

181-1 手动榻榻米升降机-大铝



型号	最低位	最高位	升起承重
181-1	310mm	720mm	≤80kg

181-2 手动榻榻米升降机-小铝



型号	最低位	最高位	升起承重
181-2	310mm	720mm	≤60kg

074-2 榻榻米专用气撑(随意停)

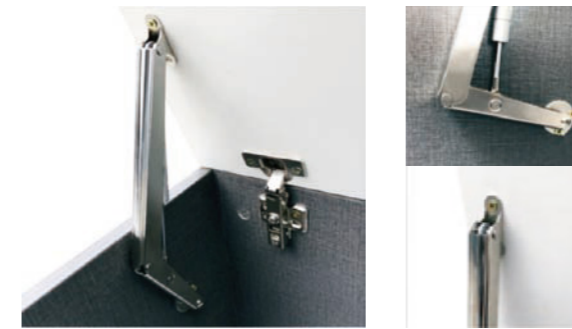

型号	规格	材质	表面
074-2	-----	铁	电镀

074-3 榻榻米专用气撑(小金刚)



型号	规格	材质	表面
074-3	-----	铁	拉丝

181-3 电动遥控榻榻米升降机



型号	最低位	最高位	升起承重
181-3A	310mm	680mm	≤100kg
181-3B	360mm	820mm	≤100kg

181-4 气动榻榻米升降机



型号	最低位	最高位	升起承重
181-4A(三节)	310mm	700mm	≤85kg
181-4B(两节)	410mm	700mm	≤85kg

182-1 榻榻米拉手



型号	规格	材质	表面
182-1	-----	-----	拉丝

182-2 榻榻米专用妆台



**低噪音，静音专用**

② 专利产品

- 防止夹手
- 静音
- 10000次开合测试
- 快捷安装
- 左右通用
- 力度调节

**调节快慢**

内部安装说明图 / 右图仅供参考

183-1 化妆镜缓冲翻板合页

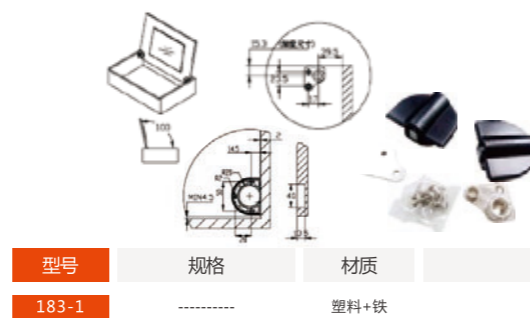

型号	规格	材质	表面
183-1	-----	塑料+铁	

183-2 缓冲折叠凳



型号	承重	材质	表面
183-2	100kg	冷轧钢	喷涂

183-3 上缓冲折叠凳配件



型号	承重	材质	表面
183-3	-----	铁	喷涂

184-1 上翻折叠桌



规格：600mm  
展开：1250mm  
适用柜体宽度：  
650-850mm

型号	承重	材质	表面
184-1	50kg	不锈钢、铁	拉丝、喷涂

184-2 下翻折叠桌



展开：1250mm  
适用柜体宽度：  
600-800mm

型号	承重	材质	表面
184-2	50kg	高强铝	喷涂

184-3 台面平移



规格：730mm  
展开：1600mm  
适用柜体宽度：  
600-1000mm

型号	承重	材质	表面
184-3	80kg	高强铝	拉丝

184-4 抽屉



规格：350mm  
展开：1250mm  
适用柜体宽度：  
600-1000mm

型号	承重	材质	表面
184-4	40kg	高强铝	拉丝



185-1 号柜



规格：350mm  
展开：1450mm  
适用柜体宽度：  
600-1000mm

型号	承重	材质	表面
185-1	80kg	高强铝	拉丝

186-1 平移桌



型号	承重	材质	表面
186-1	-----	铝	氧化

185-2 多功能柜



规格：350mm  
展开：2000mm  
适用柜体宽度：  
600-1000mm

型号	承重	材质	表面
185-2	80kg	高强铝	拉丝

186-2 书桌伸缩轨道



型号	承重	材质	表面
186-2	-----	铝	氧化

185-3 高柜



规格：350mm  
展开：1450mm  
适用柜体宽度：  
600-1000mm

型号	承重	材质	表面
185-3	40kg	高强铝	拉丝

186-3 门柜一拉得



型号	承重	材质	表面
186-3	-----	不锈钢、铁	氧化

185-4 壁桌

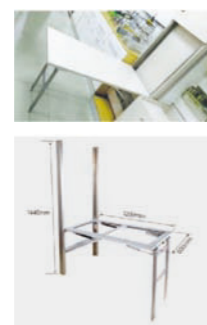

规格总高度：1440mm  
桌面长：1200mm  
桌面宽：600mm

型号	承重	材质	表面
185-4	80kg	铝、钢	氧化

186-4 多节轨单(双脚)



型号	承重	材质	表面
186-4	-----	铝	氧化

187-1 多功能壁挂餐桌



型号	颜色	材质	表面
187-1	黑色	铁	喷涂

187-2 360°衣柜(电视)旋转配件



型号	颜色	材质	表面
187-2	-----	-----	-----

187-3 小旋风

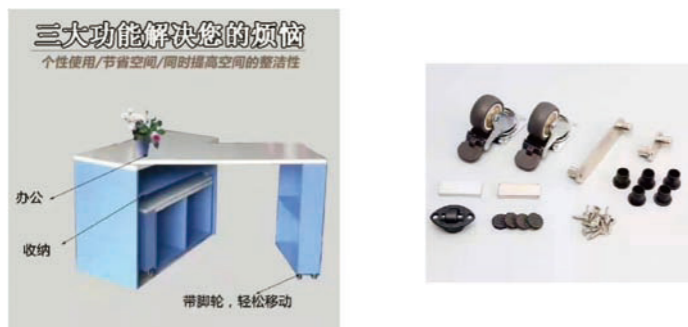

型号	承重	材质	表面
187-3	-----	-----	-----

187-4 茶几架



型号	颜色	材质	表面
187-4	黑色	铁	喷涂

188-1 180°双(回)折门



型号	颜色	材质	表面
188-1	-----	-----	-----

188-2 下翻门

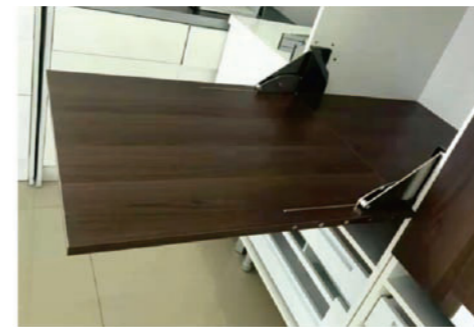

型号	颜色	材质	表面
188-2	-----	-----	-----

188-3 变形餐桌

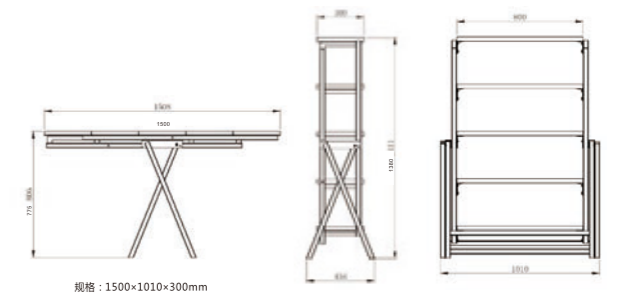

型号	颜色	材质	表面
188-3	黑色	铁	喷涂

189-1 酒杯架(单排)



规格：哑光黑、高光白

型号	规格	材质	表面
189-1	260×110mm	铁	喷涂

189-2 酒杯架



规格：青古、哑黑

型号	规格	材质	表面
189-2	320×88mm	铝	氧化

189-3 酒杯架

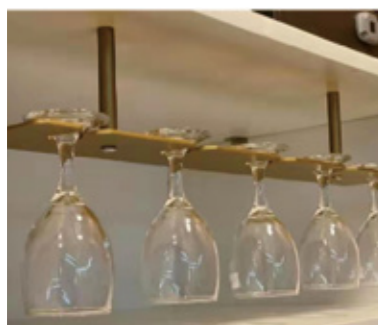

规格：青古、哑黑

型号	规格	材质	表面
189-3	60柜、80柜	铝	氧化

189-4 酒杯架



五瓶酒架  
尺寸：28×16.5×28cm

八瓶酒架  
尺寸：42×16.5×28cm

型号	规格	材质	表面
189-4	-----	铁	喷涂