

---

# User Manual

## —Energy Storage System

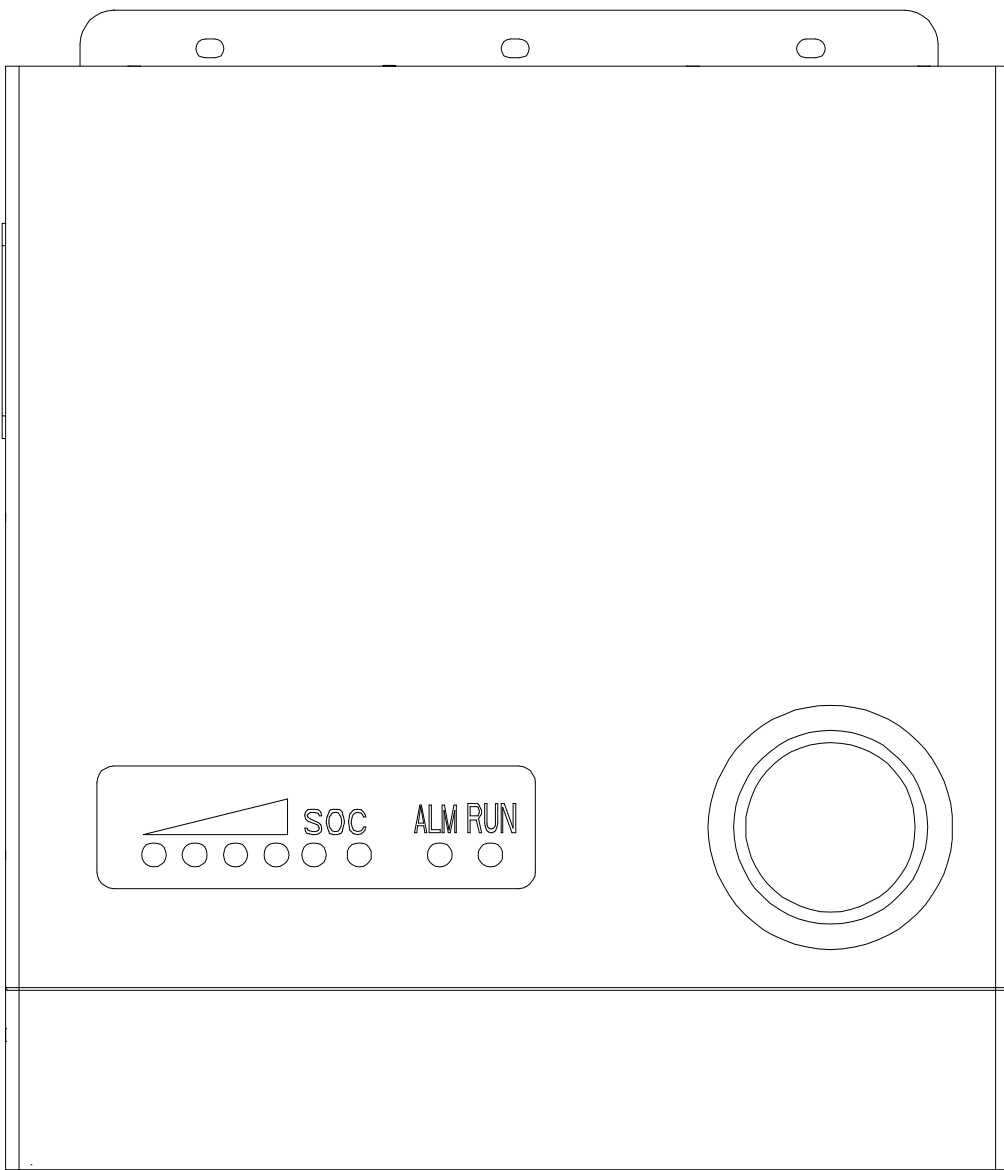

---

# CONTENT

<b>1. Introduction</b>	<b>1</b>
1.1 Brief Introduction	1
1.2 Symbol Description	1
1.3 Battery Handling Guide	1
1.4 Response to Emergency Situations	2
1.5 Installers	3
<b>2. Product introduction</b>	<b>3</b>
2.1 Package info	3
2.2 Appearance	4
2.3 Technical Data	5
<b>3. Installation</b>	<b>5</b>
3.1 Installation Precaution	5
3.2 Mounting the product	6
3.3 Cable Connection	7
<b>4. Operation</b>	<b>8</b>
4.1 Boot	8
4.2 Turn off	8
4.3 Disassembly	8
<b>5. Panel Instructions</b>	<b>8</b>
5.1 LED instructions	8
5.2 Reset Button	9
5.3 Communication Ports Definition	9
<b>6. Troubleshooting</b>	<b>10</b>
<b>7. Quality Promise</b>	<b>10</b>
<b>8. Contact</b>	<b>11</b>







---

## 1. Introduction

### 1.1 Brief Introduction

This manual will provide detailed product information and installation. Please read it carefully before use this product, and store it in a place that is convenient for installation, operation, and maintenance personnel. The manual is subject to change without notice.

### 1.2 Symbol Description

Symbol	Description
	Caution, risk of electric shock
	Heavy enough may cause severe injury
	Keep the battery away from open flame or ignition sources
	Keep the battery away from children
	Do not dispose of the product with household waste
	Recycling
	Read this manual before installation and operation

### 1.3 Battery Handling Guide

- Use the battery pack only as directed.
- If the battery defective, appears cracked, broken or otherwise damaged, or fails to operate, contact your distributor immediately.
- Do not attempt to open, disassemble, repair, tamper with, or modify the battery. The battery pack is not user serviceable.
- To protect the battery and its components from damage when transporting, handle with care.
- Do not subject it to any strong force.
- Do not insert foreign objects into any part of the battery pack.
- Do not use cleaning solvents to clean the battery.
- The battery shall not be connected directly to SELV circuit

---

## 1.4 Response to Emergency Situations

The battery is designed with multiple safety strategies to prevent hazards resulting from failures.

### 1.4.1 Leaking batteries

If the battery pack leaks electrolyte, avoid contact with the leaking liquid or gas. Electrolyte is corrosive and contact may cause skin irritation and chemical burns. If one is exposed to the leaked substance, do these actions:

**Inhalation:** Evacuate the contaminated area, and seek medical attention immediately.

**Eyes contact:** Rinse eyes with flowing water for 15 minutes, and seek medical attention immediately.

**Skin contact:** Wash the affected area thoroughly with soap and water, and seek medical attention immediately.

**Ingestion:** Induce vomiting as soon as possible, and seek medical attention immediately.

### 1.4.2 Fire

In case of a fire, make sure that an ABC or carbon dioxide extinguisher is nearby and does not use water to extinguish the fire.



#### WARNING

The battery pack may catch fire when heated above 130°C. If a fire breaks out where the battery is installed, do these actions:

1. Extinguish the fire before the battery catches fire.
2. If the battery has caught fire, do not try to extinguish the fire. Evacuate people immediately.



#### WARNING

If the battery catches fire, it will produce poisonous gases. Do not approach.

### 1.4.3 Wet battery

If the battery is wet or submerged in water, do not try to access it. Contact your distributor for technical assistance.

### 1.4.4 Damaged battery

If the battery is damaged, please contact your distributor for help as soon as possible, because a damaged battery is dangerous and must be handled with extreme caution. A damaged battery is not suitable for use and may pose a danger to people or property. If the battery seems to be damaged, return it to your distributor.



#### WARNING

A damaged battery might export electrolyte or flammable gas, so contact your distributor for advice and information immediately; we will deal with it within 48h.

## 1.5 Installers

Energy Storage battery is suggested installing by skilled worker or electrician. A skilled worker is defined as a people who had been trained and qualified electrician or had all of the following skills and experience:

- Knowledge of the functional principles and operation of on-grid Energy Storage systems.
- Knowledge of the dangers and risks associated with installing and using electrical devices and acceptable mitigation methods.
- Knowledge of the installation of electrical devices
- Knowledge of and adherence to this manual and all safety precautions and best practices.

## 2. Product introduction

### 2.1 Package info

Please confirm product packaging is not damaged before unpacked, and product is good and no accessories are missing after unpacked, otherwise, please contact the supplier immediately.

Parts list:

NO.	Description	Quantity
1	battery box	1
2	Stainless steel expansion bolt M8*80	10
3	Electric ring terminal	4
4	Drilling drawing	1
5	Certificate of conformity	1
6	Warranty Card	1
7	Manual	1

### 2.2 Appearance

Bottom Panel

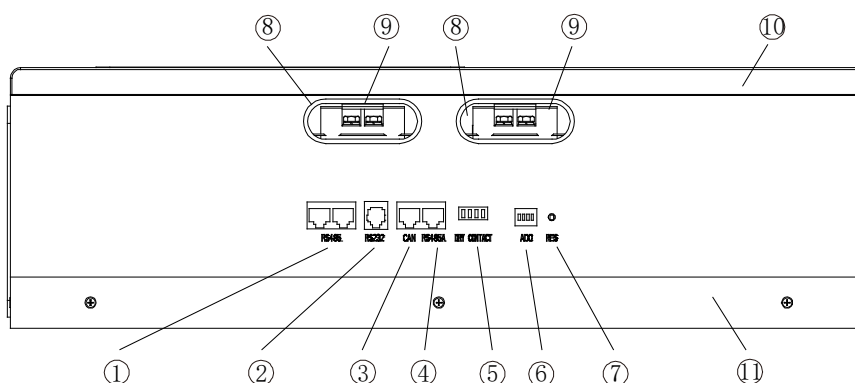

Front Panel

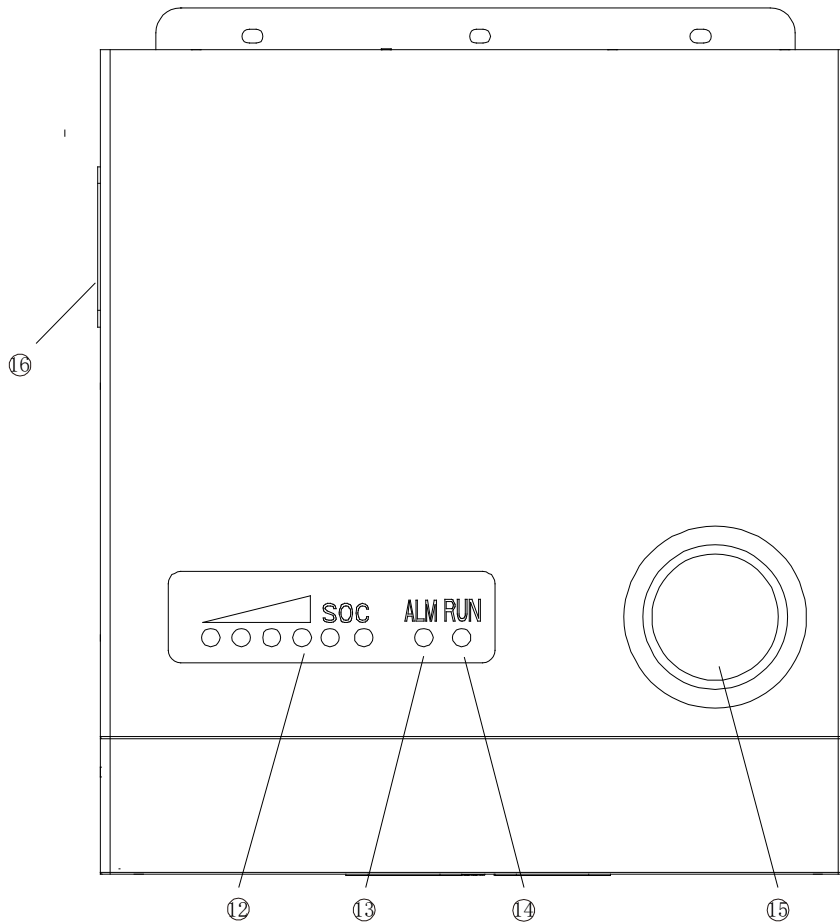

No.	Part	Remark	No.	Part	Remark
①	RS485	communicate with battery	⑨	Battery terminal block	
②	RS232	communicate with computer	⑩	Detachable front cover	
③	CAN	communicate with inverter	⑪	Detachable rear cover	
④	RS485A	communicate with inverter	⑫	SOC indicator	
⑤	Dry contact		⑬	ALM	Alarm indicator
⑥	ADD	DIP address	⑭	Run	Running indicator
⑦	Reset button		⑮	Power switch	
⑧	Holes for battery cables		⑯	Carrying handle	

### 2.3 Technical Data

No.	Item	Technical index
1	Total Energy	5.12Kwh
2	Rated Capacity	100Ah
3	Rated voltage	51.2V
4	Voltage range	48V ~ 56Vdc
5	Rated charging current	50A
6	Maximum continuous charging current	100A
7	Rated discharge current	50A
8	Maximum continuous discharge current	100A
9	Lifespan	6000 cycles
10	Max. number of parallel	16pcs
11	Communication method	CAN/RS485/RS232/Dry contact
12	Ingress protection	IP20
13	Installation type	Wall mount
14	Dimension (WxHxD)	460×470×133mm
15	Weight	Approx: 48 Kg

## 3 Installation

### 3.1 Installation Precaution

Please make sure the installation site meets below conditions:

- Not in direct sunlight
- Not in areas where highly flammable materials are stored.
- Not in potential explosive areas.
- Not in the cool air directly.
- Not near the television Antenna or antenna cable.
- Not higher than altitude of about 2000 meters above sea level.
- Not in environment of precipitation or humidity (>95%)
- Please AVOID direct sunlight, rain exposure, snow laying up during installation and operation.

Considering the following points before selecting where to install:

- Please select a vertical wall with load-bearing capacity for installation, suitable for installation on concrete or other non-flammable surfaces, installation is shown below.
- Install the product at eye level in order to allow the LCD display to be read at all times.
- The ambient temperature should be between  $-25\sim 60^{\circ}\text{C}$  to ensure optimal operation.
- Be sure to keep other objects and surfaces as shown in the diagram to guarantee sufficient heat dissipation and have enough space for removing wires.

### 3.2 Mounting the product

Remember that this product is heavy! Please be careful when lifting out from the package, please make sure wall is solid enough.

- 3.2.1 Please read drilling drawings carefully, stick it to the wall vertically, drill 5 holes at least at the bottom, 3 holes at the top, 52-60mm deep, use a proper hammer to fix the expansion bolt into the holes.
- 3.2.2 Fix the detachable rear cover to the expansion bolt.
- 3.2.3 Lift battery box and put it on the detachable rear cover against wall, fix upper hanger to the expansion bolt.
- 3.2.4 Screw detachable rear panel at the side and bottom, fix it.
- 3.2.5 Push up dataable front panel, fix it.

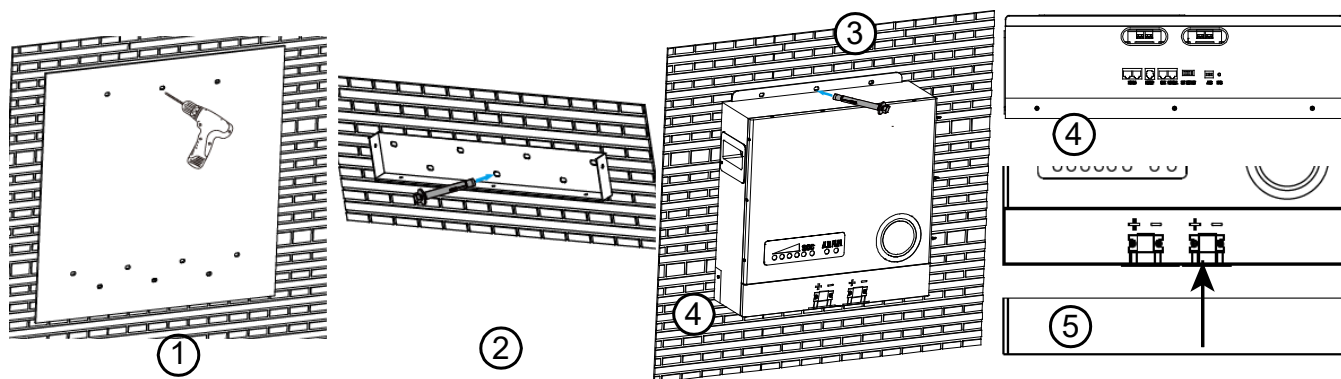



### 3.3 Cable Connection

#### 3.3.1 Power Cable Connection

Batteries support parallel connection only, connect battery positive to positive, negative to negative.

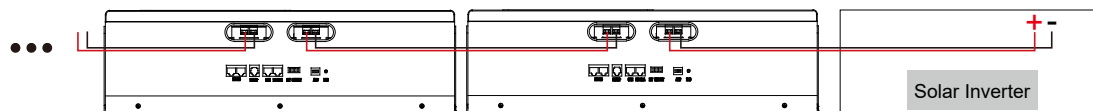

#### 3.3.2 Communication Cable Connection

Below is the picture of communication cable connection.

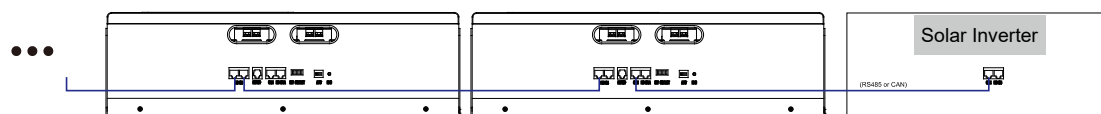

#### 3.3.3 Address Select of Primary and Sub Battery(ies) Connection

Connect the parallel communication cable like the picture above.

Set the dial address of 1# battery to 1, the dial address of 2# battery to 2, and so on, set the dial address of N# battery to N.

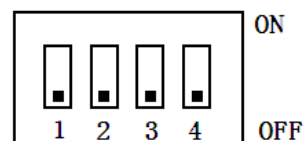

Address	DIP switch position				Description
	#1	#2	#3	#4	
0	OFF	OFF	OFF	OFF	Set to Pack 0
1	ON	OFF	OFF	OFF	Set to Pack 1
2	OFF	ON	OFF	OFF	Set to Pack 2
3	ON	ON	OFF	OFF	Set to Pack 3
4	OFF	OFF	ON	OFF	Set to Pack 4
5	ON	OFF	ON	OFF	Set to Pack 5
6	OFF	ON	ON	OFF	Set to Pack 6
7	ON	ON	ON	OFF	Set to Pack 7
8	OFF	OFF	OFF	ON	Set to Pack 8
9	ON	OFF	OFF	ON	Set to Pack 9
10	OFF	ON	OFF	ON	Set to Pack 10
11	ON	ON	OFF	ON	Set to Pack 11
12	OFF	OFF	ON	ON	Set to Pack 12
13	ON	OFF	ON	ON	Set to Pack 13
14	OFF	ON	ON	ON	Set to Pack 14
15	ON	ON	ON	ON	Set to Pack 15

## 4 Operation

### 4.1 Boot

4.1.1 Close the breaker the battery box;

4.1.2 Turn the battery box "ON/OFF" to the "ON position";

### 4.2 Turn off

Turn the "ON/OFF" of the battery box to the "OFF" position.

### 4.3 Disassembly

4.3.1 Confirm that the inverter and battery are turned off;

4.3.2 Disconnect power cables and communication cable from inverter;

4.3.3 Disconnect power cables and communication cable between batteries;

## 5 Panel Instructions

### 5.1 LED instructions

status	Normal/Alarm /Protection	RUN	ALM	Battery indicator LED						Description	
Shut down	Sleep	OFF	OFF	OFF	OFF	OFF	OFF	OFF	OFF	OFF	
Standby	Normal	Flash1	OFF	According to battery indicator						Standby	
	Alarm	Flash1	Flash3	According to battery indicator						Module low voltage	
Charge	Normal	ON	OFF	According to battery indicator (The highest battery indicator LED flashes 2)						The highest power LED flashes (flash 2), and the overcharge alarm ALM does not flash	
	Alarm	ON	Flash3	According to battery indicator							
	Overcharge protection	ON	OFF	ON	ON	ON	ON	ON	ON	If there is no grid, the indicator light is in standby state	
	Temperature, overcurrent, Failsafe	OFF	ON	OFF	OFF	OFF	OFF	OFF	OFF	OFF	Stop charging
Discharge	Normal	Flash3	OFF	According to battery indicator							
	Alarm	Flash3	Flash3	According to battery indicator							
	Undervoltage protection	OFF	OFF	OFF	OFF	OFF	OFF	OFF	OFF	OFF	Stop discharging
	Temperature, over current, short circuit, reverse connection, failure protection	OFF	ON	OFF	OFF	OFF	OFF	OFF	OFF	OFF	Stop discharging
Invalidation		OFF	ON	OFF	OFF	OFF	OFF	OFF	OFF	OFF	Stop charging and discharging

Status		Charge						Discharge					
Capacity indicator		L6	L5	L4	L3	L2	L1	L6	L5	L4	L3	L2	L1
SOC (%)	0 ~ 16.6%	OFF	OFF	OFF	OFF	OFF	Flash2	OFF	OFF	OFF	OFF	OFF	ON
	16.6 ~ 33.2%	OFF	OFF	OFF	OFF	Flash 2	ON	OFF	OFF	OFF	OFF	ON	ON
	33.2 ~ 49.8%	OFF	OFF	OFF	Flash 2	ON	ON	OFF	OFF	OFF	ON	ON	ON
	49.8 ~ 66.4%	OFF	OFF	Flash 2	ON	ON	ON	OFF	OFF	ON	ON	ON	ON
	66.4 ~ 83.0%	OFF	Flash 2	ON	ON	ON	ON	OFF	ON	ON	ON	ON	ON
	83.0 ~ 100%	Flash2	ON	ON	ON	ON	ON	ON	ON	ON	ON	ON	ON
Running light		ON						Flash					

## 5.2 Reset Button

- 5.2.1 When the BMS is in the dormant state, press REST (3~6S) and then release, the protection board is activated, and the LED indicator lights start from "RUN" for 0.5 seconds.
- 5.2.2 When the BMS is in the active state, press REST (3~6S) and then release it, the protection board is dormant, and the LED indicator lights turn on for 0.5 seconds from the lowest battery light.
- 5.2.3 When the BMS is in the active state, press REST (6~10S) and then release, the protection board is reset, and all the LED lights are on for 1.5 seconds at the same time.

## 5.3 Communication Ports Definition

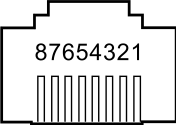
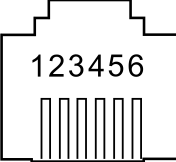
Port	Serial number	Definition	Remark
RS485 ①	1	RS485B	
	2	RS485A	
RS485A ④	1	RS485B	
	2	RS485A	
CAN	5	CANH	
	4	CANL	
RS232	1	GND	
	2	RX	
	3	TX	
Dry contact	1	Normally open, low battery closed	
	2		
	3	Normally open, closed for fault protection	
	4		

---

## 6 Troubleshooting

Our products have been strictly tested before they leave the factory. If there are operating difficulties during installation and use, please read the relevant chapters of this manual.

When a failure occurs, please inform our company and provide relevant information about the inverter. We will have professional after-sales service personnel will answer for you.

The information you need to provide includes:

- Model
- A short description of the problem
- Battery voltage
- Grid voltage and frequency
- Battery capacity
- Battery output voltage
- Battery purchase time

### Warning message

Accident details	Description	Suggestion
The battery cannot be turned on	LED light does not light up	Disconnect the positive and negative poles of the battery, restart the battery, if it still reports an error, please contact the manufacturer
Voltage failure	Check LED instructions or battery data	Check the battery data, if the lowest voltage is less than 2V, please contact the manufacturer
Temperature failure	Check LED instructions or battery data	Check whether the ambient temperature exceeds the charging and discharging temperature of the battery
Current failure	Check LED instructions or battery data	Disconnect the positive and negative poles of the battery, restart the battery, if it still reports an error, please contact the manufacturer
Short circuit fault	Check LED instructions or battery data	Disconnect the positive and negative poles of the battery, restart the battery, if it still reports an error, please contact the manufacturer
Inverter communication failure	The inverter cannot obtain battery data	1. Check whether the battery interface definition is the same as that of inverter; 2. Check whether the battery communication protocol is the same as that of inverter

## 7 Quality promise

For products that fail during the warranty period, our company will repair or replace them with new products free of charge.

Warranty products require that the company requires customers to provide invoices and dates for purchasing products during the warranty period. At the same time, the trademark on the product should be clearly visible, otherwise it has the right not to guarantee the quality. The replaced product will be handled by our company, and the customer should allow the company a certain amount of time to deal with the failure.

### Exemption

The company reserves the right not to guarantee quality if the following situations occur:

- 
- Beyond the free warranty period
  - Incorrect installation, modification or use
  - Operation beyond the very harsh environment described in this manual
  - Machine failure or damage caused by unauthorized installation, repair, modification or disassembly
  - Machine failure or damage caused by the use of non-standard components or software
  - Anything beyond the scope of installation and use specified in relevant international standards
  - Damage caused by abnormal natural environment

If the product fails due to the above situation, the customer requires maintenance service.

After the judgment of the company's service organization, paid maintenance services can be provided.

## **8 Contact**

If you have any questions about our products, please contact our after-sales service hotline or distributors. When inquiring, please provide the following information:

1. Fault information
2. Display information
3. Battery model
4. Battery capacity and connection method.