

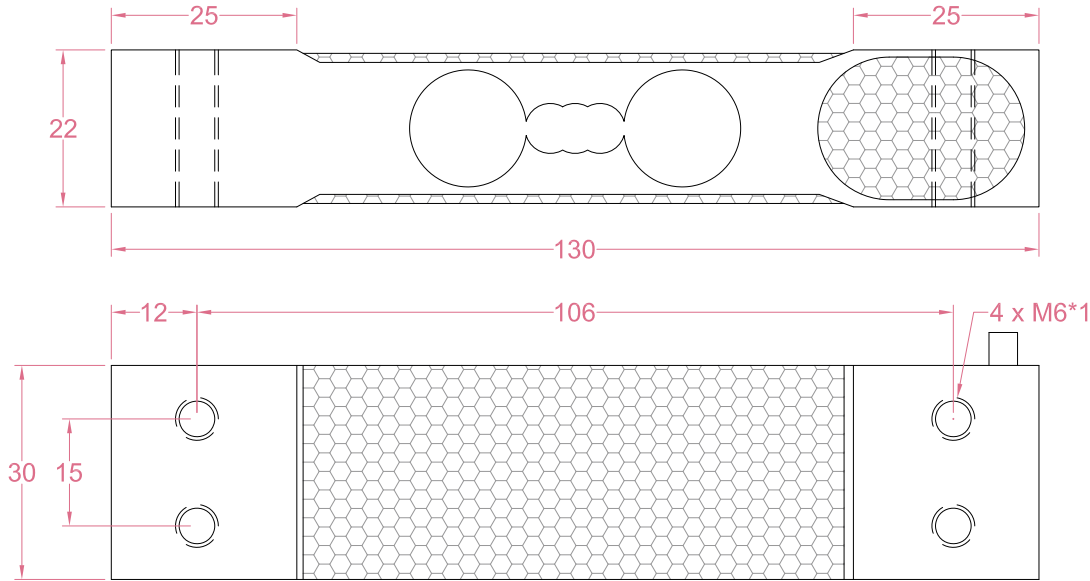

Dimensions in "mm"



Order example:

2 x LCE10 - 10kg

Quantity Model Capacity
 Email to sales@loadcellsensor.com for a quote

Specifications			
Rated Capacity	3/6/10/20/40 kg		
Rated Output	2.0±0.2 mV/V	Compensated Temp.	-10...+40°C
Excitation	3~15V	Operating Temp.	-20...+60°C
Zero Balance	±0.1 mV/V	Temp. Coeff. of Zero	±0.002% F.S./°C
Nonlinearity	±0.017% F.S.	Temp. Coeff. of Span	±0.002% F.S./°C
Hysteresis	±0.017% F.S.	Input Resistance	405±10 Ohms
Nonrepeatability	±0.01% F.S.	Output Resistance	352±5 Ohms
Creep(30min)	±0.02% F.S.	Insulation Resistance	>2000M Ohms(50V)
Safe Load Limit	150% F.S.	IP Rating	IP65
Breaking Load	200% F.S.	Element Material	Aluminum alloy
Cable	Ø4*400mm 4-conductor shielded cable		

• LCS reserves the right to modify its design and specifications without notice



Load direction

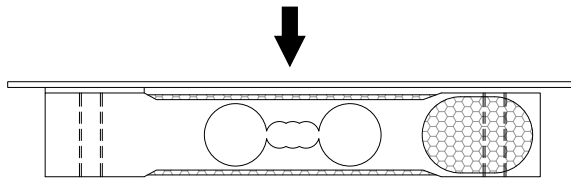

Suitable for off center load measurement.
 Platform size goes up to 250x350mm

Wiring Code

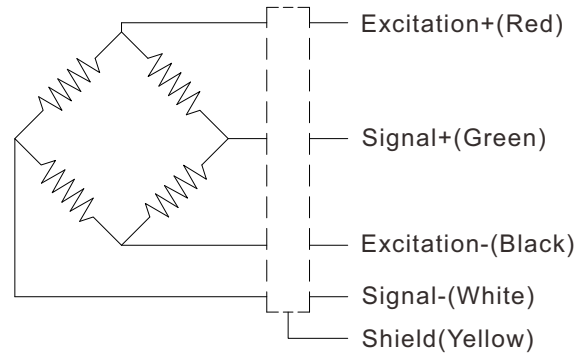

Shield is NOT connected to the sensor body

Sensor/Amplifier/Indicator

Items	Power supply	Output/Function
LCE10	3-15V (Constant)	0mV...+30mV (Depending on the power supply)
LCE10 + Analog amplifier	12~24V DC	0-3.3V,0-5V,0-10V, 0-20mA,4-20mA...
LCE10 + Digital amplifier	12~24V DC	RS485 or RS232 output
LCE10 + Indicator	12~24V DC	Display force value Switch/Relay output Peak holding RS485/RS232 interface 0-5V/0-10V/4-20mA output
Email us for datasheet of amplifier and indicator		