

USER INSTRUCTIONS

OF HEAT PUMP ENERGY RECOVERY VENTILATOR

AV-HTPF35

AV-HTPF60

AV-HTPF90

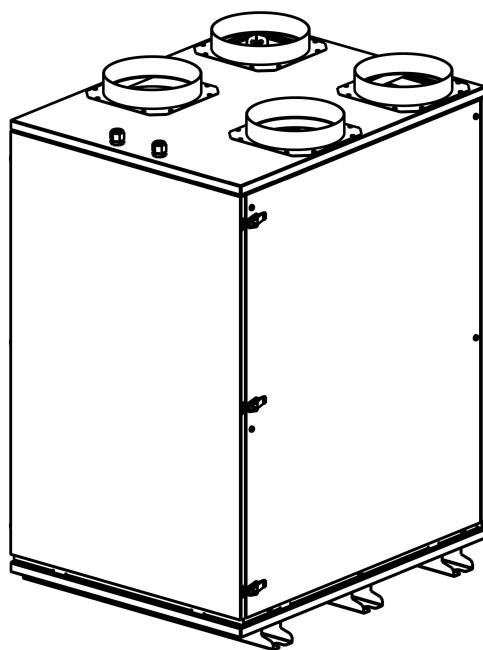

Attention

Please read this manual carefully before using the equipment

| Contents

Safety Considerations	3
Specifications	4
Dimensions	5
Control System Wiring Diagram Display	7
Screen And Buttons	8
Touch Screen Controller Instructions	9
WIFI Module Manual	23
Maintenance	24
Installations	26
Trouble Shooting.....	28
R32 Refrigerant Safety Overview	29
Vacuuming and Filling Refrigerant	31
Maintenance of R32 Fresh Air Heat Pump	33

I Safety Considerations

1. Safety marks contained in these instructions.

- If the safety precautions marked by this symbol are not complied with, injuries to persons may be caused.
- If the safety precautions marked by this symbol are not complied with, damage to the machine or to its functions may be caused.



2. Please read the label on the machine carefully.

When abnormal conditions happen, like abnormal noise, smell, smoke, temperature rise, leakage or fire, please cut off power immediately. And contact our customer service department or distributor. Don't repair it by yourself. Please contact fire and rescue department if necessary.

3. R32 is slightly flammable, for your safety please read the precautions carefully before installation or use.

- All installation and maintenance work should be carried out by qualified personnel, in particular work on the refrigeration system should be carried out by personnel qualified to use R32 refrigerant.
- All fire sources and potential fire sources (including static electricity) are prohibited during installation and maintenance of fresh air heat pumps (R32 refrigerant).
- The R32 leak detector must be operational during installation; if the alarm goes off, stop work immediately (especially welding) and open windows and doors for ventilation. Do not enter the site until the alarm has been silenced.
- Special care should be taken when welding pipes: first recover the refrigerant. The pipeline should then be purged with an inert gas and evacuated more than twice.
- Keep the electrical parts away from water to maintain good electric insulation.
- Complete the grounding engineering according to the Electrical Safety Regulations to avoid leakage.
- The machine needs to be used with special power supply. Don't share the circuit with other equipment.
- The machine should be fastened at the place of flatness and good ventilation and keep proper distance with surrounding.
- Keep the machine away from fire and pollutant.
- It is not recommended to place the machine under the sun and rain.
- Keep the children away from the machine.
- Random change of specification by user is not allowed.
- It is prohibited to use the volatile solvent, volatile oil, toluene and other chemicals besides or above the machine.
- Make sure the machine doesn't put on the cable, and the cable is completely fine, in case of any danger of leakage and fire.
- Don't operate or repair the machine with wet hands.
- Under no conditions should users repair the machine by themselves. Only the professionals are authorized to repair the machine, it may result in personal injury or more serious problem to the equipment.
- Don't wash the machine directly with water or cleanser. Need to scrub by cloth with water or mild detergent.
- For avoiding machine breakdown or any danger, it is prohibited to insert objects into the air outlet.
- Users could not modify or repair the power wire.
- It is prohibited to put anything on the machine, in case it falls down during the operation of the machine and cause danger.

I Specifications

Model		AV-HTPF35	AV-HTPF60	AV-HTPF90	
Rated airflow	CMH	350	620	950	
Exhaust Airflow (Ventilation mode)	CMH	350	620	950	
Exhaust Airflow (Heating/Cooling mode)	CMH	350	620	950	
External static pressure	Pa	100	100	100	
Ventilation mode	Temperature Effi. (Winter)	%	77	78	77
	Temperature Effi. (Summer)	%	72	72	73
	Enthalpy Effi. (Winter)	%	76	77	70
	Enthalpy Effi. (Summer)	%	70	65	66
	Input power	W	185	451	788
	Input current	A	1.67	3.77	3.93
Cooling/ Heating	Normal Cooling Capacity	W	3798	6394	8293
	Max Cooling Capacity	W	4173	6946	8801
	Input power (Cooling)	W	847	1243	1487
	Operation Current (Cooling)	A	4.43	6.55	6.95
	Normal Heating Capacity	W	4631	6287	8870
	Max Heating Capacity	W	4981	6921	9110
	Input power (Heating)	W	790	1033	1427
	Operation Current (Heating)	A	3.91	5.74	6.76
Noise	dB(A)	37 / 42	40/44.6	41/46	
Power		220V 1P 50/60Hz			
Dimension	mm	600x760x1010	740x1050x990	740x1090x1130	
Weight	Kg	135	165	195	
Air Inlet/Outlet Diameter	mm	195	245	245	
Air Inlet/Outlet Height	mm	40			
Machine Base Height	mm	40			
Drainage pipe		G1/2 21mm			
Refrigerant		R32			
Refrigerant charge	g	370	500	660	
Operation Temperature	°C	-15~50			

I Dimensions

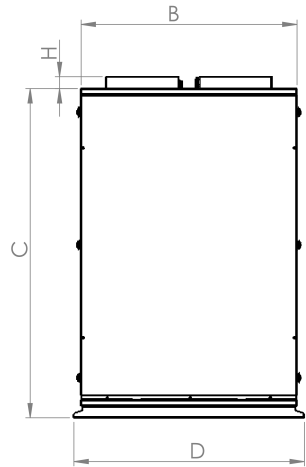
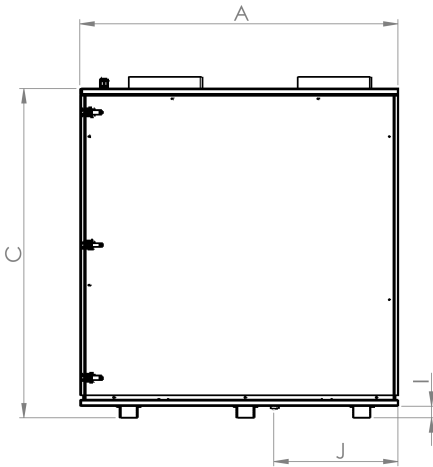
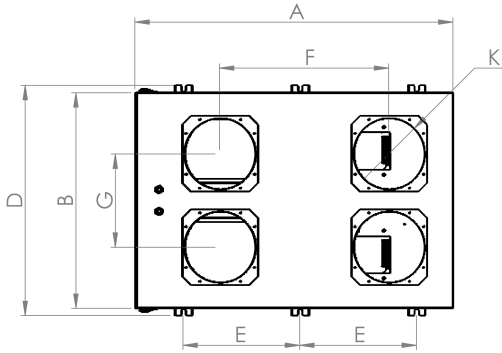

Model	A	B	C	D	E	F	G	H	I	J	K
AV-HTPF35	760	600	1010	650	280	335	370	40	40	305	φ 195
AV-HTPF60	1050	740	990	790	400	540	320	40	40	415	φ 245
AV-HTPF90	1090	740	1130	790	400	580	320	40	40	425	φ 245

| Assembly drawing

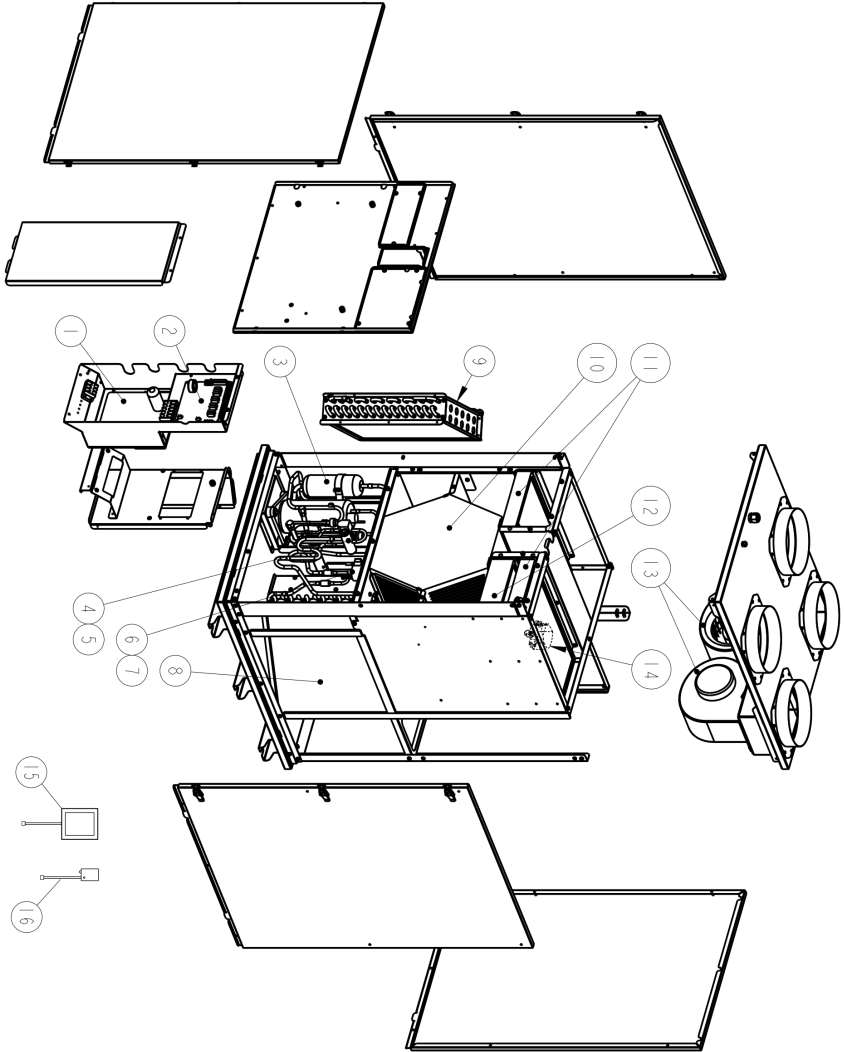

No.	PART NAME	QTY
16	WIFI MODULE	1
15	CONTROLLER	1
14	BYPASS EXECUTOR	1
13	FAN BLOWER	2
12	FILTER (F8)	1
11	FILTER (G4)	2
10	FULL HEAT EXCHANGER	1
9	EVAPORATOR	1
8	CONDENSER	1
7	SOLENOID COIL (EXP_V)	1
6	EXPANSION VALVE	1
5	SOLENOID COIL (4WAY)	1
4	4WAY REVERSING VALVE	1
3	COMPRESSOR	1
2	CONTROL BOARD	1
1	POWER BOARD	1

I Control System Wiring Diagram

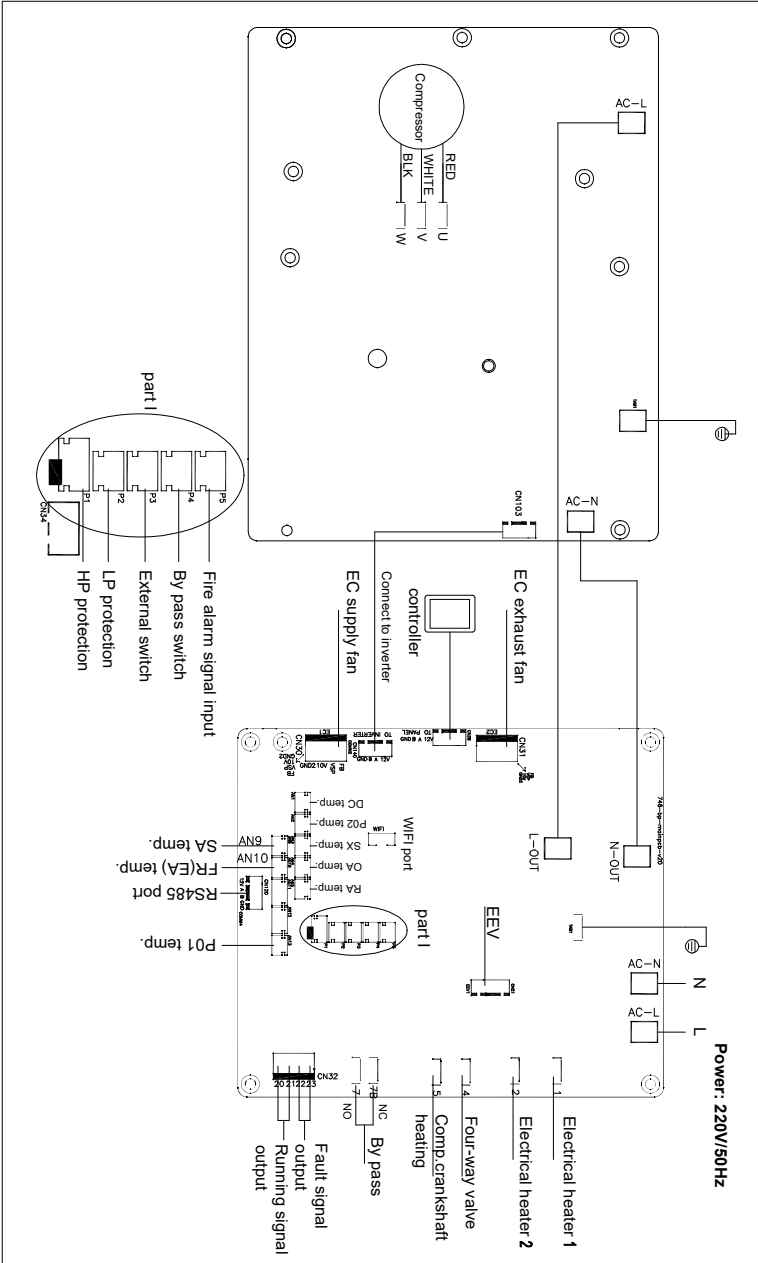

I Display Screen And Buttons

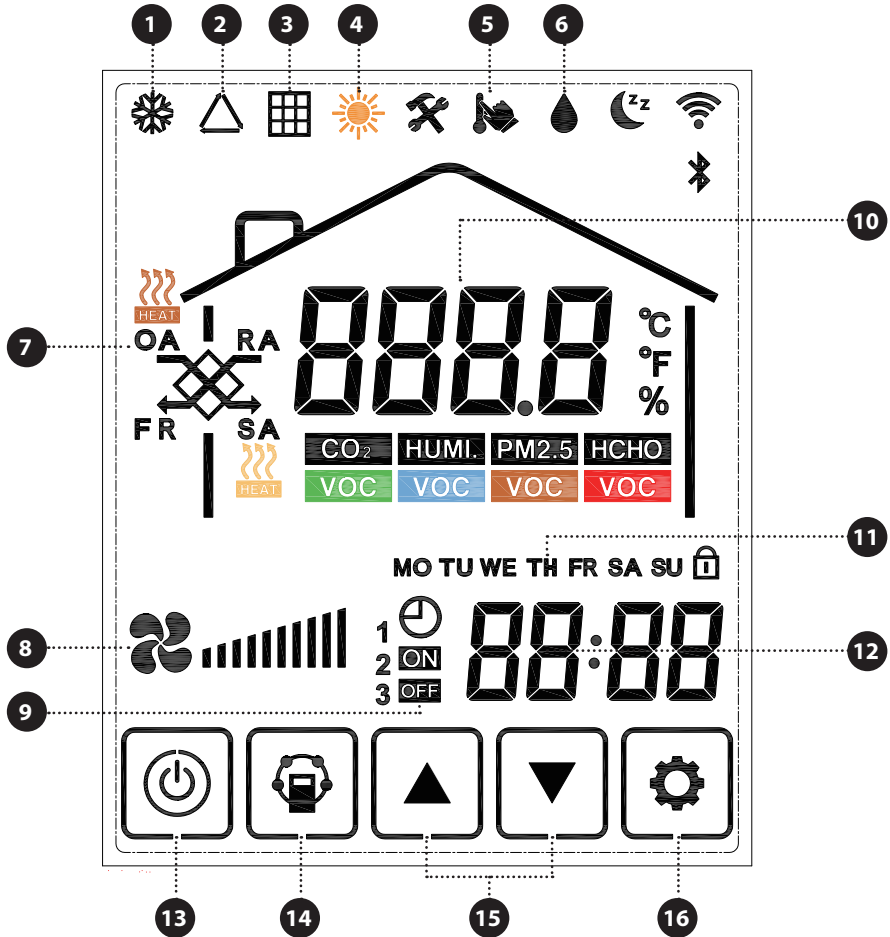

- | | | |
|-------------------------|------------------------|-------------------|
| 1 Cooling mode | 7 Temperature type | 13 ON/OFF button |
| 2 Ventilation mode | 8 Fan speed | 14 Mode button |
| 3 Filter alarm | 9 Weekly timer on/off | 15 Up/Down button |
| 4 Heating mode | 10 Temperature display | 16 Set button |
| 5 SA setting | 11 Week day | |
| 6 Dehumidification mode | 12 Clock | |

| Touch Screen Controller Instructions

1. On/Off

ON/OFF: press ON/OFF button  once for starting; twice for closing.

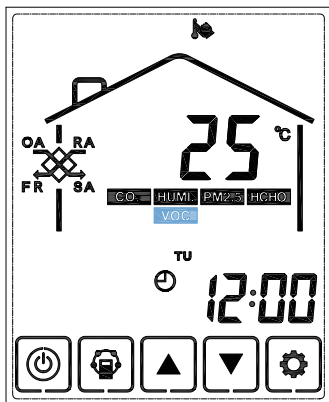

OFF state

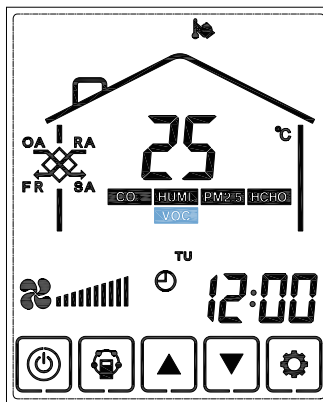

ON state

2. Lock/Unlock

Pressing ON/OFF button  for around 6 seconds can lock and unlock the controller.

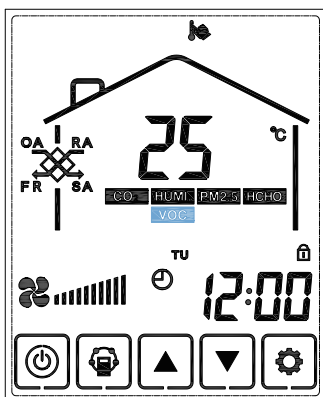

Lock state

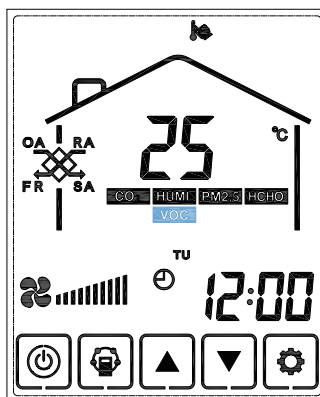

Unlock state

Touch Screen Controller Instructions

3. Status checking

Press MODE button  to choose display the RA-OA-FR(EA)-SA.



RA temperature

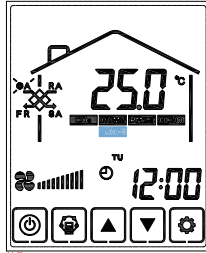

OA temperature

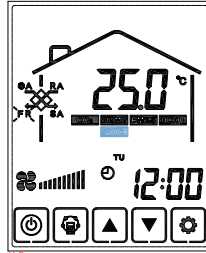

FR temperature

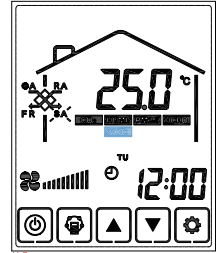

SA temperature

Press MODE button  to choose display the SA setting-CO₂-Humidity- PM2.5.

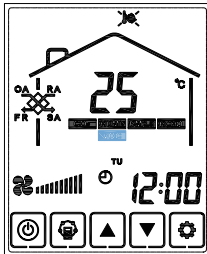

SA temperature setting

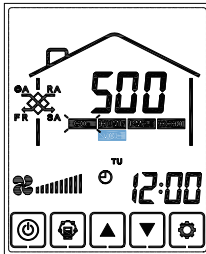

CO₂ concentration

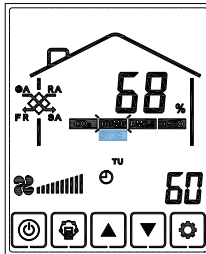

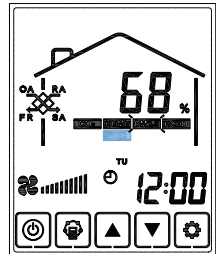

Humidity control
Setting range 45-90%



PM2.5 display

| Touch Screen Controller Instructions

4. SA setting mode

Under SA setting mode, press UP or DOWN button   to set SA temperature. The setting temperature range is 10-40°C. The equipment will control the compressor frequency and start/stop according to the set temperature.

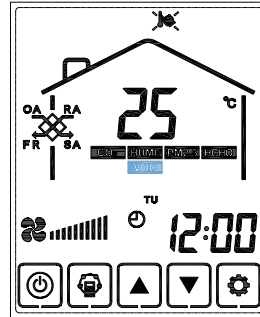

5. Mode switch

Press SET button  to switch to different modes. The sequence is Cooling mode-Heating mode-Auto mode (Turn into cooling or heating mode according to RA temperature)-Dehumidification mode-Ventilation mode.

Auto mode control logic:

$T_{SET} - T_{SA} > 2^{\circ}\text{C}$ operates in heating mode, $T_{SA} - T_{SET} > 2^{\circ}\text{C}$ operates in cooling mode,

$T_{SET} - T_{SA} \leq \pm 2^{\circ}\text{C}$ operates in ventilation mode

T_{SET} : target SA temp. T_{SA} : measured SA temp.

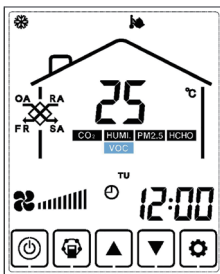

 Cooling mode

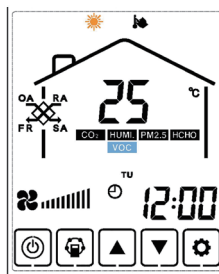

 Heating mode

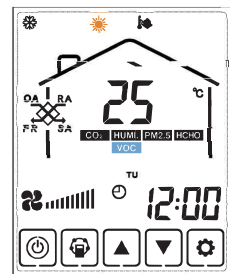

 Auto mode

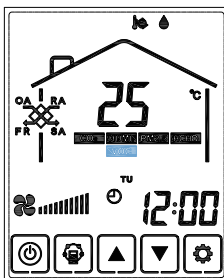

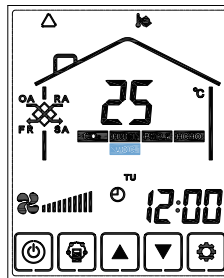

 Dehumidification mode



 Ventilation mode

| Touch Screen Controller Instructions

6. Fan speed

Air volume setting: Under SA or RA temperature interface. Users can set the return air volume in "RA" status, and set the supply air volume in "SA" status by pressing up and down button  . Totally 10 speeds control.

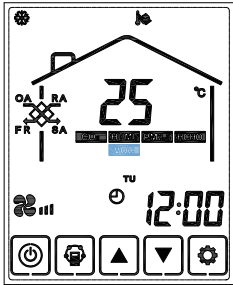

Speed 3

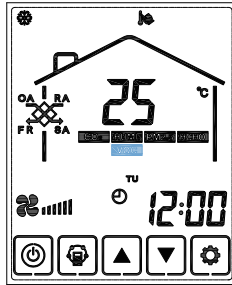

Speed 6

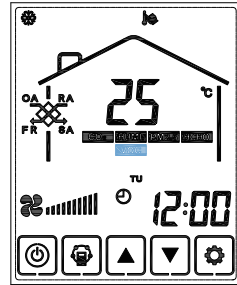

Speed 10

Note:



For proper operation of the refrigeration system.

In cooling, heating and dehumidification modes, the fan airflow is adjustable from 5 to 10.

★When controlled by APP, it is strongly recommended to set the fan speed to 5 or higher in these modes to avoid malfunction.

In ventilation mode, the fan airflow adjustment range is 1 to 10.

7. Parameter check

Press UP and DOWN button   for around 6 seconds simultaneously to the interface of parameter setting.

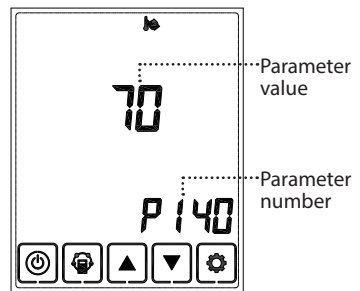
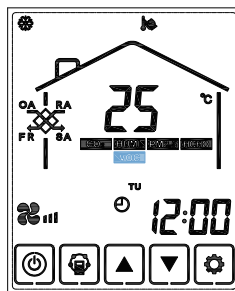

| Touch Screen Controller Instructions

Parameter number	Parameter items
P0	RA temperature
P1	FR(EA) temperature
P3	SA temperature
P4	OA temperature
P8	IPM inverter module temperature
P13	Coil heat exchanger temperature (condenser in cooling mode)
P14	Suction temperature of compressor
P17	Discharge temperature of compressor
P32	Coil heat exchanger temperature (evaporator in cooling mode)
P140	Current operating frequency of compressor
P142	Fan 1 speed
P143	Fan 2 speed

8. IAQ parameter check

Press the MODE and UP button for more than 6 seconds to the IAQ parameter check. Press SET button to switch the parameter display, press UP and DOWN button change IAQ display.

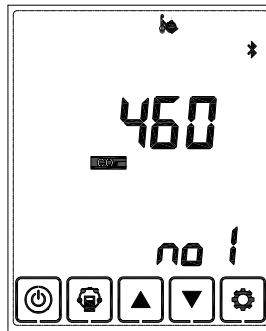

IAQ parameter display interface

9. Setting parameters

Long press the "MODE" button for more than 6 seconds under the power on state (or off state) to enter into the interface for parameters setting.

And then shortly press the "▲" and "▼" button, the parameter number will increased accordingly. After choosing the corresponding parameter item, press "MODE" button to choose, press the arrow buttons of "▲" and "▼" to adjust the parameter values. When all setting is done, press the "SET" button to save the setting.

Please refer to below valid parameters table to set the suitable parameters according to different requests.

I Touch Screen Controller Instructions

Control parameter table

Add:	Content	Range	Default	Record
00	Power to auto restart	0~1	1	PCB
01	Electrical Heater valid or invalid	0~1	0	PCB
02	Bypass opening temperature X	5-30 °C	19	PCB
03	Bypass opening temperature range Y	2-15 °C	3	PCB
04	Defrosting interval	15-99 minutes	30	PCB
05	Defrosting enter temperature	-9-5 °C	-1	PCB
06	Defrost duration time	2-20 minutes	10	PCB
07	Fresh Air CO2 sensor value setting (Wireless data first, local second)	0=function off, 50-250=CO2 setting range(500-2500) unit:PPM	0	PCB
08	Fresh Air: Ambient temperature for entering defrost timer	0~-15°C	-15	PCB
09	SW4-1	0-1: 0-Traditional EA fan defrost. 1-OA side electrical heater defrost.	0	PCB
10	SW4-2	0-1: 0-Auto by-pass and manual bypass via voltage free connector (free cooling).	0	PCB
11	SW4-3	0-1: 0-CO2 sensor. 1-Humidity and temperature sensor.	0	PCB
13	Filter alarm timer	Unit: day	20	PCB
14	Zigbee control address	1-15	1	Controller
15	Wireless humidity correction value	Unit: %	8	Controller
16	Wireless temperature correction value	Unit: °C	-2	Controller
24	Multiple function setting	0: Reserved 1: Filter alarm clearance 2: Weekly timer clearance	0	

I Touch Screen Controller Instructions

10. Error code checking

In the main interface, if there is a fault in the whole machine, ERRO will be displayed on the APP, and the fault code will be displayed on the main interface of the online controller. If there are multiple faults, press the set key to view each fault code. Press the “▲” and “▼” keys to exit the fault code display interface.

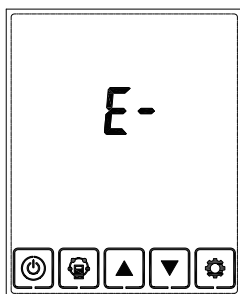

No error

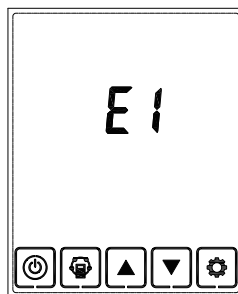

Error alarm

Code	Error
E01	High pressure switch open/break
E02	High pressure protection
E03	Low pressure switch open/break
E04	Low pressure protection
E06	Compressor current protection
E08	Discharge temperature protection
E09	Discharge temperature sensor error
E10	Suction temperature sensor error
E11	Evaporator temperature sensor error
E12	Ambient temperature sensor error OA
E14	RA temperature sensor error
E16	SA temperature sensor error
E19	Ambient temperature too low to run air-source
E20	Fault 3-phase
E21	Communication error
E29	Condenser temperature sensor error
E58	Fr temperature sensor error
E59	EC fan 1 no speed
E60	EC fan 2 no speed
E70	Inverter module no communication
E74	Inverter module running no good
E77	Inverter module frequency no good
En	Panel and controller no communication for 30 seconds

| Touch Screen Controller Instructions

11. Time setting

Keep pressing the SET button for 6 seconds, after buzzing to enter the time setting interface. Under this interface, press the MODE button shortly, then can switch from time setting, day setting, weekly timer on and weekly timer off setting.

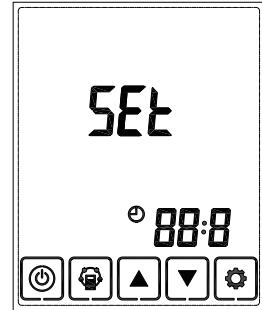

Time setting



Week setting

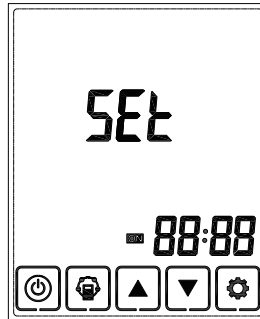

Weekly timer on

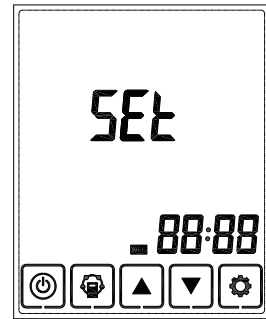

Weekly timer off

- Time setting: under time setting interface, press SET button for short, at this time "hour" flashes, press UP and DOWN button to change "hour". After setting "hour", press MODE button for short to switch to "minute" setting, at this time "minute" flashes, press Up and Down button to change "minute". After time setting, press SET button to save and return to the main interface.

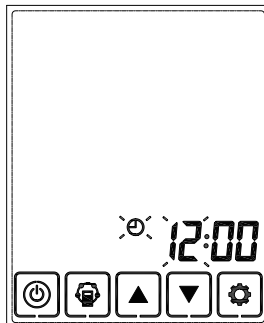

Hour setting

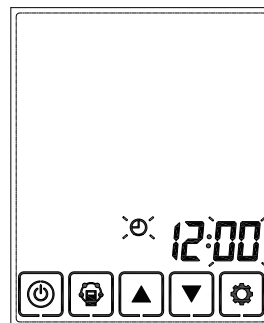

Minute setting

I Touch Screen Controller Instructions

- II. Day setting: under day setting interface, press SET button for short to begin the day setting, by pressing UP and DOWN buttons to select the correct day, after this finished, press SET button to save and return to the main interface.

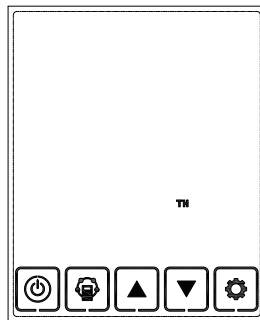

Day setting

- III. Weekly timer on setting: under weekly timer on setting interface, press SET button to begin the timer on setting, press SET button time after time to select Monday period 1 to Sunday period 2 (namely Monday period 1 to Sunday period 2).

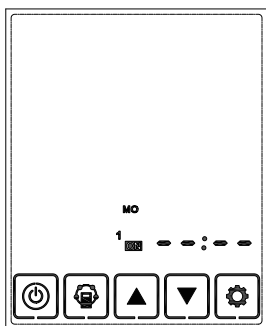

Period 1 timer on

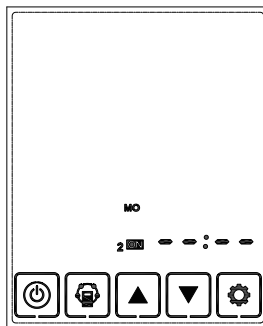

Period 2 timer on

After selecting the day, press ON/OFF button to confirm timer on is valid/invalid.

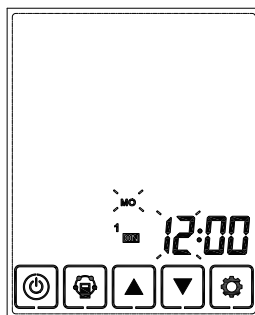
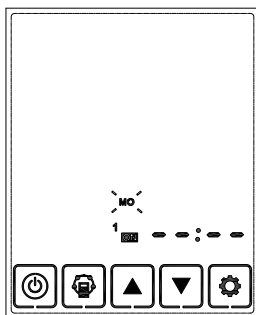

I Touch Screen Controller Instructions

When timer on is valid, press MODE button to enter “hour” setting, by pressing UP and DOWN button to set “hour”. After “hour” setting, press MODE button to enter “minute” setting. After “minute” setting, press SET button to save and switch to the next day timer on setting, and repeat the above steps to set all days and periods timer on. After setting all the time on, press SET button to save the data.

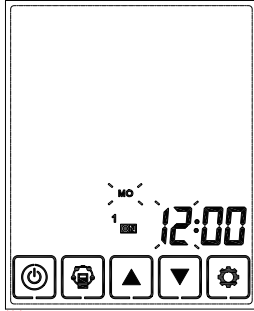

Timer on hour setting

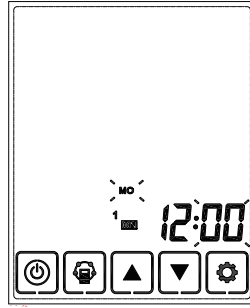

Timer on minute setting

IV. Weekly timer off setting: under weekly timer off setting interface, press SET button for short to begin the timer off setting, press SET button time after time to select Monday period 1 to Sunday period 2 (namely Monday period 1 to Sunday period 1 then Monday period 2 to Sunday period 2).

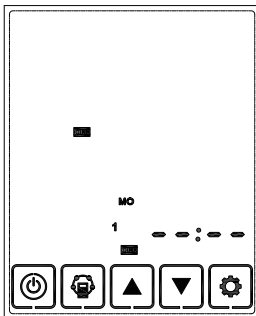

Period 1 timer off

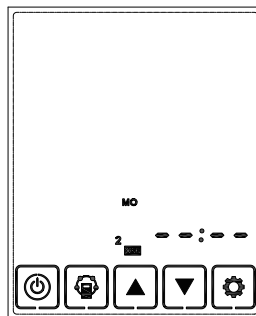

Period 2 timer off

| Touch Screen Controller Instructions

Under the week interface, press ON/OFF button to confirm the timer off is valid/invalid.

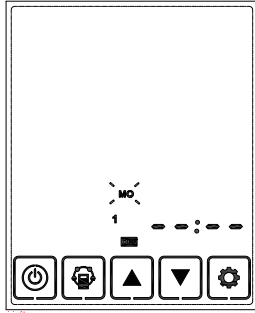

Timer off invalid

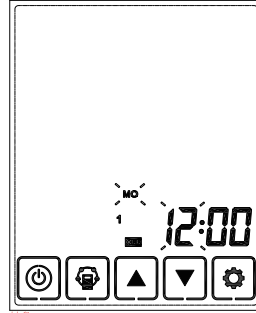

Timer off valid

When timer off is valid, press MODE button to enter "hour" setting, by pressing Up and Down button to set "hour", after "hour" setting, press MODE button to enter "minute" setting, after "minute" setting, press SET button to save and switch to the next day timer off setting and repeat the above steps to set all days and periods timer off. After setting all the timer off, press SET button to save the data.

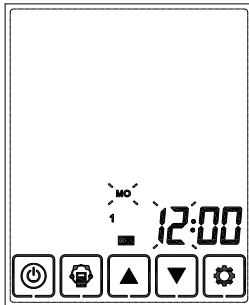

Timer off hour setting

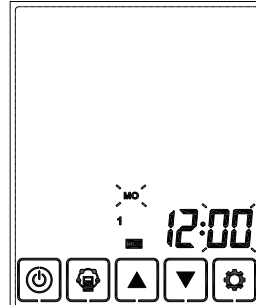

Timer off minute setting

Attention: Under time setting, if no operation for 10 seconds, system will return to the main interface automatically.

| Touch Screen Controller Instructions

12. SA electric heater

Parameter 01 refers to the function of the SA electric heater

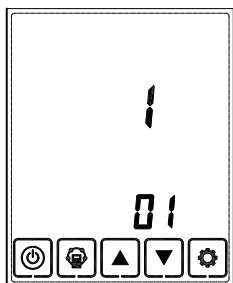

0: OFF 1: ON

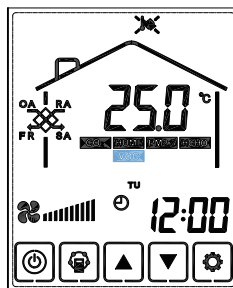

When connecting the SA electric heater, the user should switch parameter 01# to "1" to activate the electric heater function and Parameter 09# to "0"
Under the SA temperature setting interface, the SA temperature can be set by UP and DOWN buttons. Setting range is 10-40°C.

SA Electric Heater Wiring Diagram

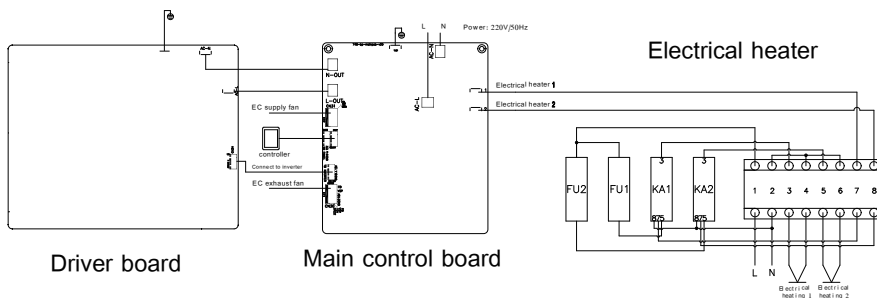

I Touch Screen Controller Instructions

When connecting the SA electric heater, the user should switch to 1 to activate the electric heater function. Under the SA temperature setting interface, the SA temperature can be set by UP and DOWN buttons. Setting range is 10-40°C.

A) $0\text{ }^{\circ}\text{C} < \text{setting temperature minus SA temperature} < 2\text{ }^{\circ}\text{C}$, 1st stage heater on, 2nd stage heater off

B) Setting temperature minus SA temperature $> 5\text{ }^{\circ}\text{C}$, 1st and 2nd stage heater on

C) When the SA temperature increases and if $0\text{ }^{\circ}\text{C} < \text{setting temperature minus SA temperature} < 2\text{ }^{\circ}\text{C}$, the second stage heater turns off, if SA temperature \geq setting temperature, both the two stages heaters turn off.

Note:

When the ventilator is in cooling and dehumidification mode, the SA electric heater is unavailable.

When the ventilator is in the heating and ventilation mode, SA electric heater can be turned on according to the following controls:

13. OA electric heater

1. Parameter 09# is to switch defrosting mode. The default is "0", which means traditional EA fan defrosting. When turning to "1", the defrosting mode is changed to OA heater defrosting (need to connect the heater to OA air duct and OA heater defrosting is only recommended where in winter is long time below $-15\text{ }^{\circ}\text{C}$). Parameter 01 is to activate the heater function, only when parameter 01 value is 1, the electric heater function is on.

Note:

When the ventilator is in cooling and dehumidification mode, the OA electric heater is unavailable.

When the ventilator is in the heating and ventilation mode, OA electric heater can be turned on according to the following controls:

a. When the compressor turns on, if OA temperature $\leq -15\text{ }^{\circ}\text{C}$. the OA heater turns on, if the OA temperature $\geq -5\text{ }^{\circ}\text{C}$, the OA heater will turn off.

b. After the compressor is shut down for 5 minutes or in fresh air mode, the OA heater works as follows:

1) If the OA temperature $< -15\text{ }^{\circ}\text{C}$, turns on the OA heater for 50 minutes, and then turns off for 10 minutes and restarted.

2) If the OA heater is turned on and the EA temperature is $< -1\text{ }^{\circ}\text{C}$, the ventilator will stop for 50 minutes.

| Touch Screen Controller Instructions

- 3) If the EA temperature is $< -1^{\circ}\text{C}$ and the outdoor air temperature is $> -15^{\circ}\text{C}$, the OA heater will start for 10 minutes and stop for 30 seconds. If the state continues, the OA heater will start and stop again according to the preceding steps.
- 4) If the OA heater is turned on and the OA temperature $\geq 25^{\circ}\text{C}$, the OA heater will stop. After the OA electric heater is turned off when the OA is $< -15^{\circ}\text{C}$, the OA heater will be turned on again and repeat the above steps.

OA Heater Wiring Diagram

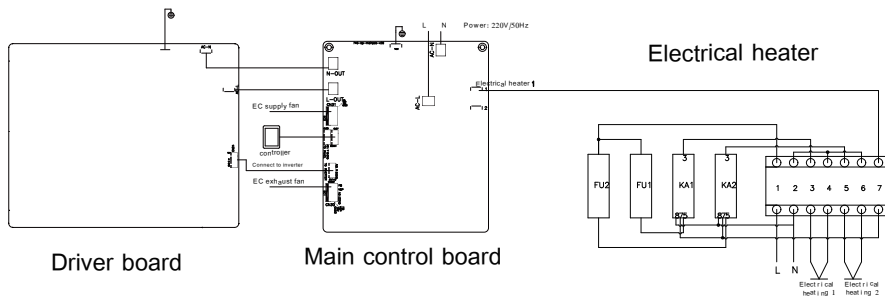

14. EA Fan defrost mode

(EA fan defrost is not available when the compressor is on. This function is available only after the compressor is off for 5 minutes)

Setting parameter 01 value to be 0 and setting parameter 09 value to be 0, the EA fan defrost function is activated.

When EA temperature $< -1^{\circ}\text{C}$ (settable by parameter 05) and lasts for 1 minute, and the frost interval is more than 30 minutes (settable by parameter 04), the EA fan automatically runs at high speed to defrost and the SA fan stops.

Until the EA temperature $> 15^{\circ}\text{C}$ for 1 minute or the defrosting time is more than 10 minutes (settable by parameter 06), the defrosting mode stops, both fans return to the previous conditions.

15. Automatic bypass function

Set parameter 10# to 0 (automatic bypass function)

The bypass is opened on the condition : $X \leq \text{OA temperature} < X+Y$

X Bypass opening temperature (parameter 02)

X+Y Bypass opening temperature range (parameter 03)

WiFi Module Manual



1. APP download

Scan the QR code as below, or search "Smart Life" at Apple Store or Google Play Store to install the APP.

2. WIFI module connected to fresh air heat pump

- Open the controller box of Fresh air heat pump.
- Refer to the wiring diagram of Fresh air heat pump in the user manual, connect the wifi module to the PCB and ensure the wifi network signal can cover the module.
- Take a pin, press and hold the wifi module "Black button" on the back for 6 seconds, until the red light flashes one time every 0.5 seconds.

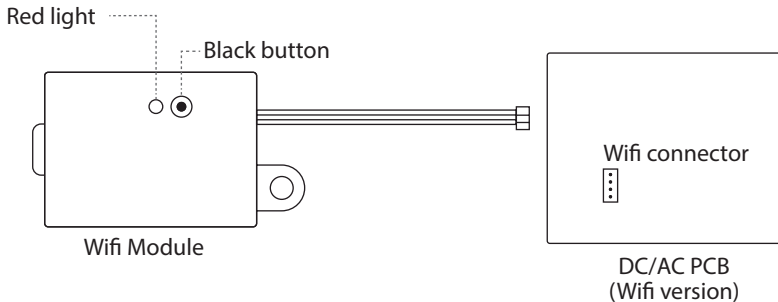

3. Network Connection

- Enter the app, register and login accordingly
- Under the home page, press the "+" at top right, and "Devices to be added" will pop up. Press "go to add" to connect the Fresh air heat pump.
- Chose the wifi network selection (Only 2.4G WIFI networks are supported), input correct wifi password. Press "Confirm" and wait for the Fresh air heat pump to be connected to the mobile phone.
- After the connection is successful, press  to edit the Fresh air heat pump name, and press "Save" to enter the Fresh air heat pump name control page.

| Maintenance

1. Caution

Power must be isolated before installation and maintenance to avoid injury or electric shock. Supply power cables, main circuit breaker and earth leakage protection, must comply with national regulations.

Failure to observe could cause unit failure, electric shock or fire.

Standard filtration is supplied with this unit and must be used. Dust and dirt can accumulate in the heat exchanger if filters are removed. (This can lead to failure or decreased performance). To ensure efficient operation, regular cleaning or replacement of filters is required. Filter maintenance frequency will depend on working environment and unit running time.

2. Cleaning the filter

1. Open the access door.
2. Remove the filters (from the side of the unit).
3. Vacuum the primary filters to get rid of the dust and dirt.
4. Push the filters to the positions after they get dried naturally, close the access door.
5. Change the filters if they are badly affected with dust and dirt or if they are broken.

Note: filters are not washable.

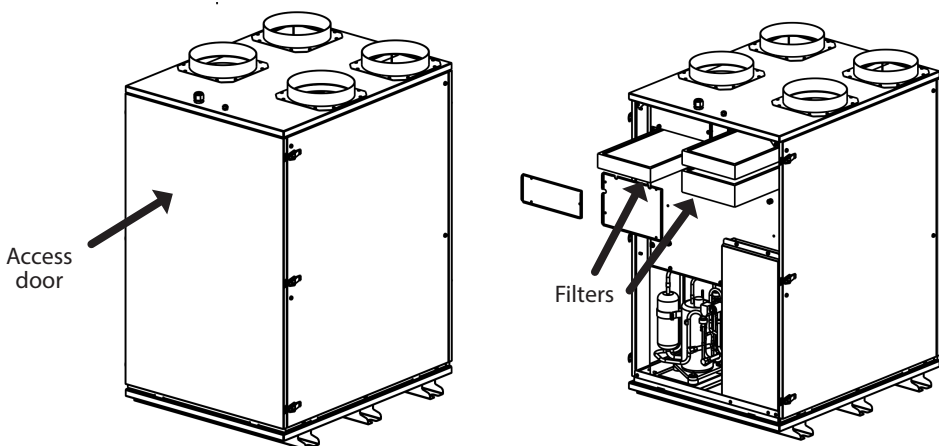

| Maintenance

3. Maintenance of heat exchanger

1. Open the access door.
2. Remove the heat exchange core and clean it with water.
3. Establish a cleaner schedule to clean the dust and dirt on the exchanger.
4. Install the access door to its positions.

Remarks: It is recommended maintenance of the exchanger is made every 2-3 years.

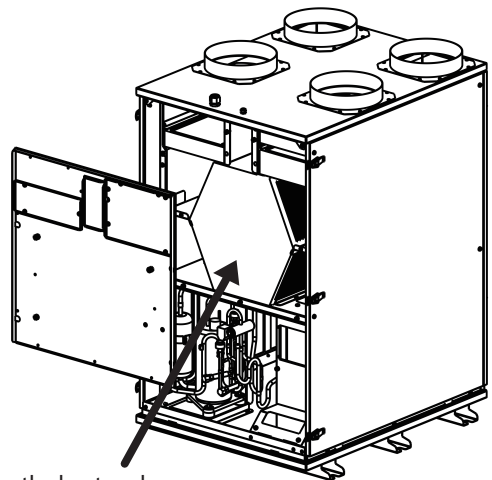
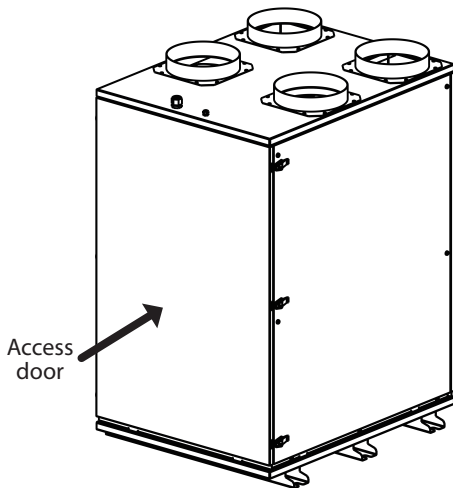

| Installations

1. Installation position

- Leave enough space for installation and maintenance.
- There are no obstacles near the inlet and outlet, which can not be blown by strong winds.
- Dry and well ventilated.
- No flammable leak.
- Place on the flat surface, which can withstand the unit weight, unit can be installed levelly, and does not increase the noise and vibration.
- Running noise and expel the air does not affect the neighbors.
- Install connecting pipe and do the wiring correctly.

2. Installation precautions

Installation in the following places may lead to machine failure.

- Places with organic oil lamps mineral oil.
- Places with corrosive gases such as sulfur gas in hot spring areas.
- Places such as inside cars or cabins.
- Places with strong electromagnetic waves.
- Places with acidic and alkaline gases evaporate.
- Places where there is more salt in the air such as the seaside.
- Places such as factories with severe fluctuations in power supply voltage.
- Places filled with oil gas and oil splashes such as kitchens.
- Places where flammable gases and materials are present.
- Other special environments.

3. Precautions before installation

- Find the correct path to move in.
- Try to carry the unit in original condition.
- If the unit is installed on the metal part of the building, the electrical insulation should be done well and comply with the relevant technical standards for electrical equipment.

I Installations

4. The unit should be installed with access space shown in the figure.

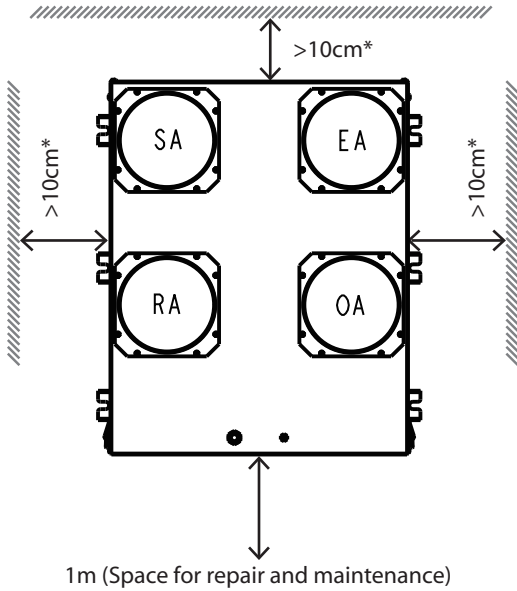

* >10cm of the distance is to ensure the normal operation of the machine. The access door side of the machine should have space of more than 1m, which will be more convenient for future maintenance.

5. Installation of drainage pipe

- The unit should be placed on a platform or holder that is more than 10cm off the bottom.
 - Connect to the condensate drainage port of the unit with a hose (drainage port connection size 3/4 inch).
 - The slope of the drainage pipe must be larger than 1/100.
 - To prevent condensation on the surface of the drain pipe, the surface of the drain pipe should be wrapped with insulation cotton.
- * There must be a back water to connect the drainhose

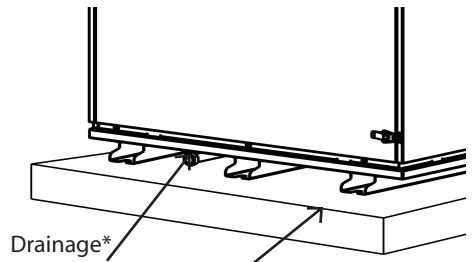

A platform or holder that is more than 10cm off the bottom

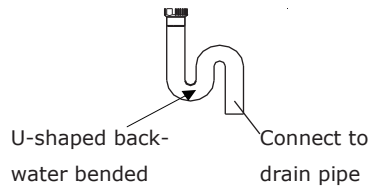

I Trouble Shooting

User can use the unit after trial operation. Before contacting us, you can make self trouble shooting following below chart in case of any failure.

Phenomenon	Solutions
The airflow volumes both in door and outdoor vents drop obviously after a period of operation.	Dust and dirt blocking the filter. Replace or clean the filter.
Noise comes from vents.	Vents installation are loosing. Re-tightening the vents connections.
Unit doesn't work.	1. Guarantee power is on. 2. Connect the breaker.
No readings on the remote controller (blank display).	Check if the mains power is still connected to your installation.
One of the error codes appears.	Consult your local dealer. Refer to the installation manual for a detailed list of error codes.
Capacity shortage.	Consult your local dealer.

| R32 Refrigerant Safety Overview

1. Refrigerant properties

- Automatic combustion temperature of R32 is 648°C.
- International standards ISO817 and ISO5149 define its safety level as A2L, which means that R32 cannot be ignited by any ignition source other than an open flame, and it will automatically extinguish as soon as it leaves the open flame.
- The working environment of the R32 refrigerant in the fresh air heat pump is completely sealed and has undergone strict anti-leakage and anti-entrainment treatment. As long as it is installed in a standard and used normally, there is no need to worry about safety issues! In fact, it is safer than the natural gas used in our homes.



2. Refrigerant safety

- **Installation room for the fresh air heat pump:**
The indoor unit is installed in a closed machine room.
The outdoor unit is installed inside the shutter.
- **Carrying out plumbing repairs in enclosed spaces. At a concentration of 14%, it can burn if it comes into contact with the source of the fire.**

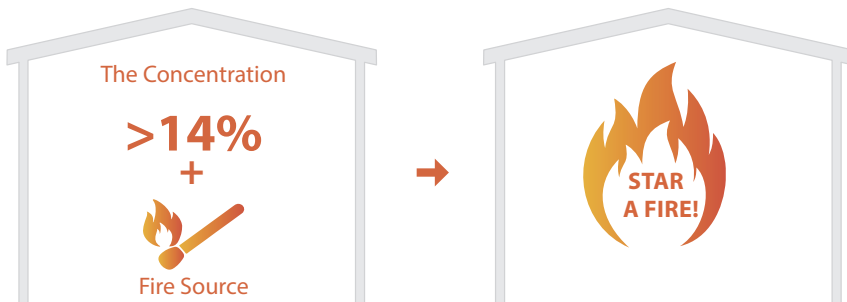

| R32 Refrigerant Safety Overview

R32 slightly flammable:

Oxygen R32 is heavier than air and has strong sedimentation properties. The concentration below is relatively high, and the combustion within 40 cm from the ground will exceed 4 times its normal burning speed

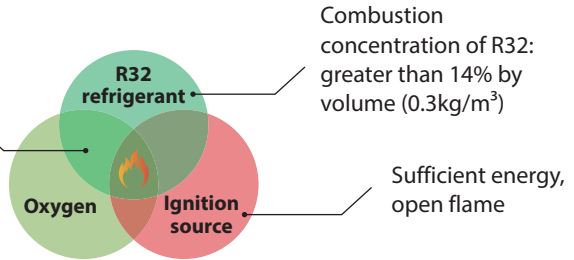

Burning the three elements



- The installation, refrigerant charging, maintenance and other operations of this product must be carried out by qualified personnel.
- Customers are not allowed to work on their own as this may result in serious safety accidents!

I Vacuuming and Filling Refrigerant

1. Connect and tighten the high and low pressure connections of the vacuum pump and the fresh air heat pump using a pressure gauge as shown in the diagram. Pay attention to the colour of the hoses. The pressure gauge valve must be closed at this stage.

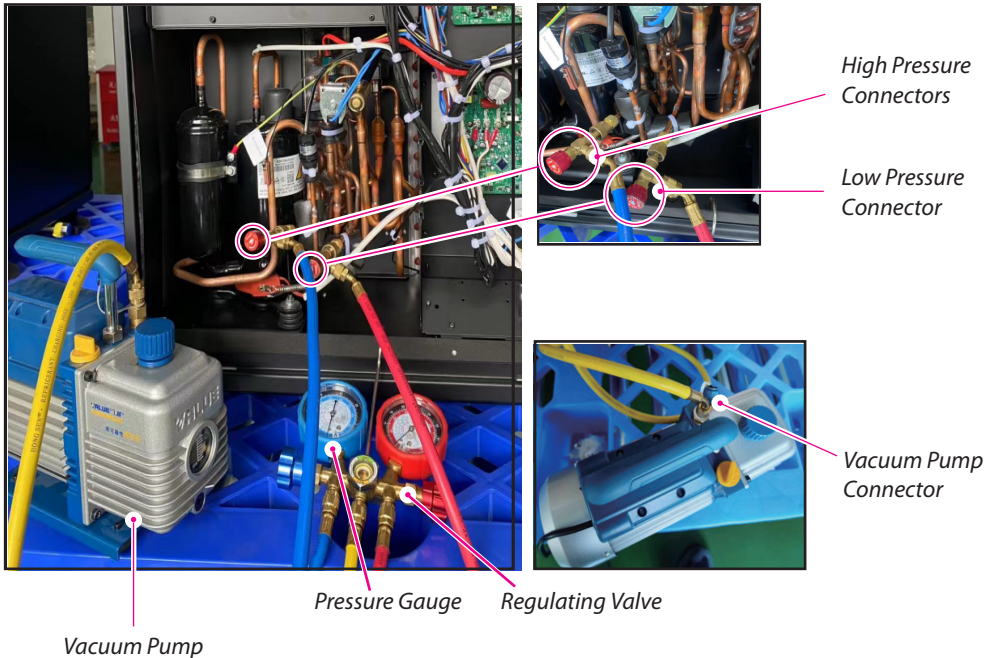

2. Start the vacuum pump, open both valves until the needle of the pressure gauge (high and low) points to 0, run the vacuum pump for at least 15 minutes, switch off the vacuum pump and close the pressure gauge valve.
3. Disconnect the yellow tube from the vacuum pump and connect it to the refrigerant tank (ensuring that the tank is closed).
4. Partially open the switch on the refrigerant tank, you will hear a noise, then close the switch.
5. Gently press the thimble valve marked with a red arrow, using a screwdriver, and immediately release it (within 0.5 seconds).

I Vacuuming and Filling Refrigerant

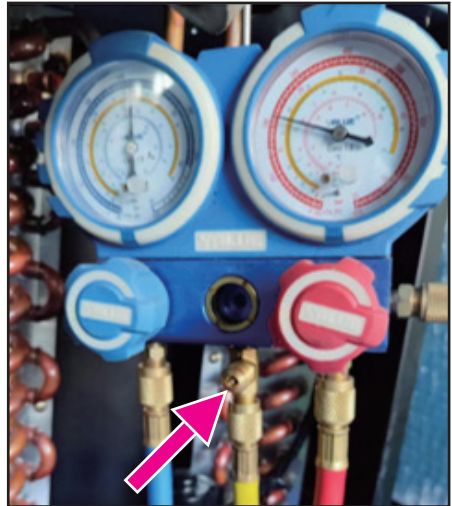
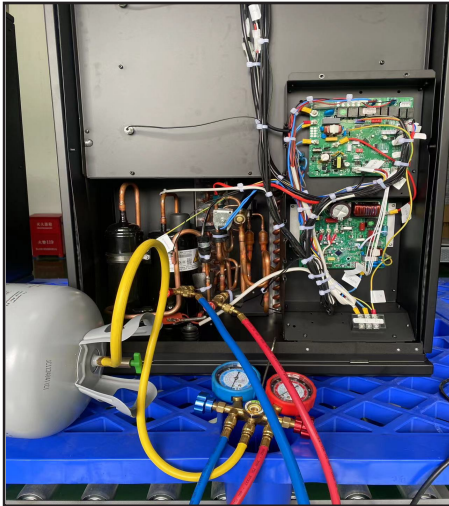

6. Repeat steps 4 and 5 several times to ensure that all the air in the yellow tube is removed.
7. Place the refrigerant tank onto the electronic scale, ensuring that the R32 bottle is positioned either sideways or squarely, and the R410A bottle is placed upside down. Please note that the bottle in the picture is being used solely for demonstration purposes.
8. Keep the red valve closed, but open the blue valve for low pressure before you turn on the switch for the refrigerant tank. Check the electronic scale readings before charging the specified amount of refrigerant. Once you have finished charging, close the refrigerant tank switch and the blue valve on the pressure gauge.
9. Wear protective gloves suitable for antifreeze before rapidly disconnecting the high and low pressure connections from the machine. It is important to do this quickly due to the risk of refrigerant escaping from the high-pressure heat pump. Only professionally trained and competent personnel should conduct this operation, as it is a hazardous process.
10. Once the refrigerant has been successfully added, the machine may be started for operation.

| Maintenance of R32 Fresh Air Heat Pump

- **Qualification Requirements For Service Personnel**

All operating or servicing personnel must hold a valid certificate issued by an industry-recognised assessment body to confirm that they are qualified to handle refrigerants safely in accordance with industry-recognised assessment specifications.

Equipment maintenance and repair should only be carried out in accordance with the methods recommended by the equipment manufacturer. If other professionals are required to assist in the maintenance and repair of the equipment, this should be carried out under the supervision of personnel qualified to use R32 refrigerant.

- **Site Inspection**

Before servicing a fresh air heat pump using R32 refrigerant, a safety check must be carried out to ensure that the risk of fire is minimised. When servicing a refrigeration system, take the precautions described below before working on the system.

- **Operating Procedures**

Operations should be carried out under controlled procedures to ensure that the risks caused by R32 refrigerant during operation are minimised.

General work area All maintenance personnel and others in the work area should be aware of the nature of the work they are doing. Avoid working in confined areas. Work areas should be properly segregated to ensure safe working conditions within the work area by controlling combustible materials.



AIRWOODS
Building Living Quality

Guangzhou Airwoods Environment Technology Co., Ltd.
www.airwoods.com info@airwoods.com