

Linear Opal series

Application

They are idea to be used as inground light, facade lighting, outdoor ceiling light, suspended pendent light ect..

-- PMMA IP67 bar
Opal diffusor with super visual comfort light



No dark areas between 2PCS

Rimless trim

clear +opal two colours PMMA

3 Years Warranty

CE RoHS COMPLIANT
IK08 IP67



with suspended rope



With mounting box



with brackets

1.

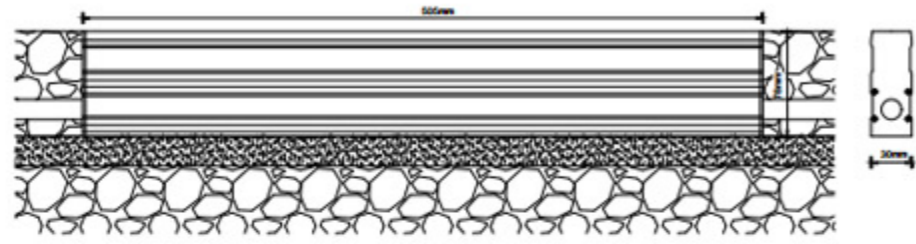

2.

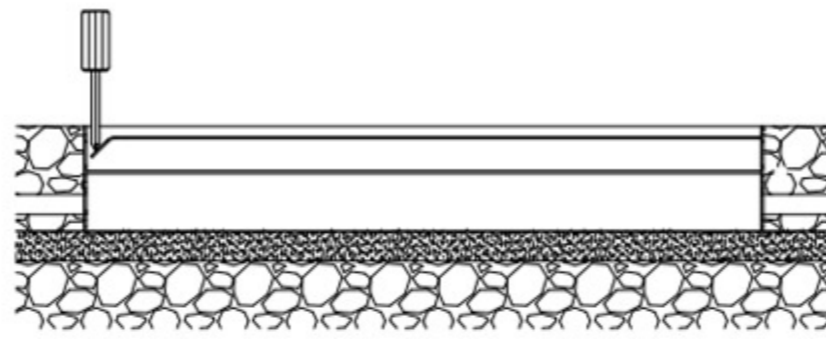

3.

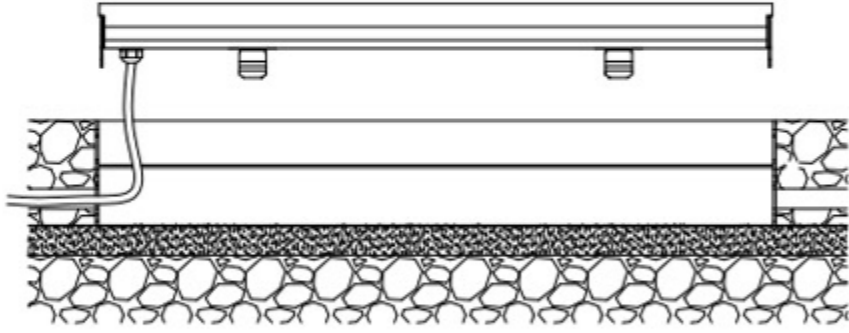

4.

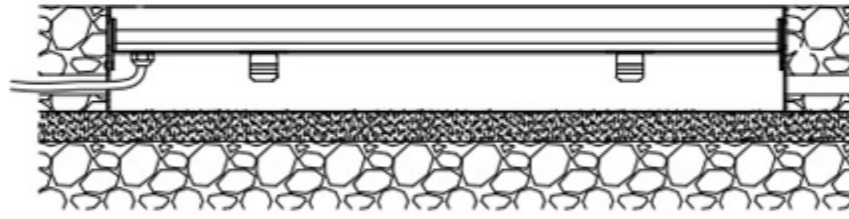

5.

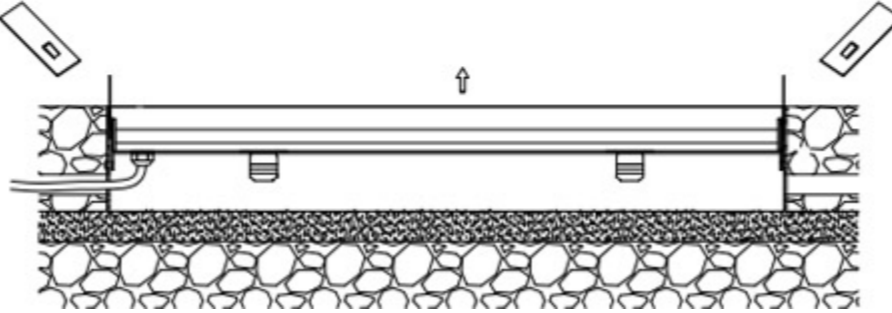

Mounting box installation



SS304 suspended rope installation

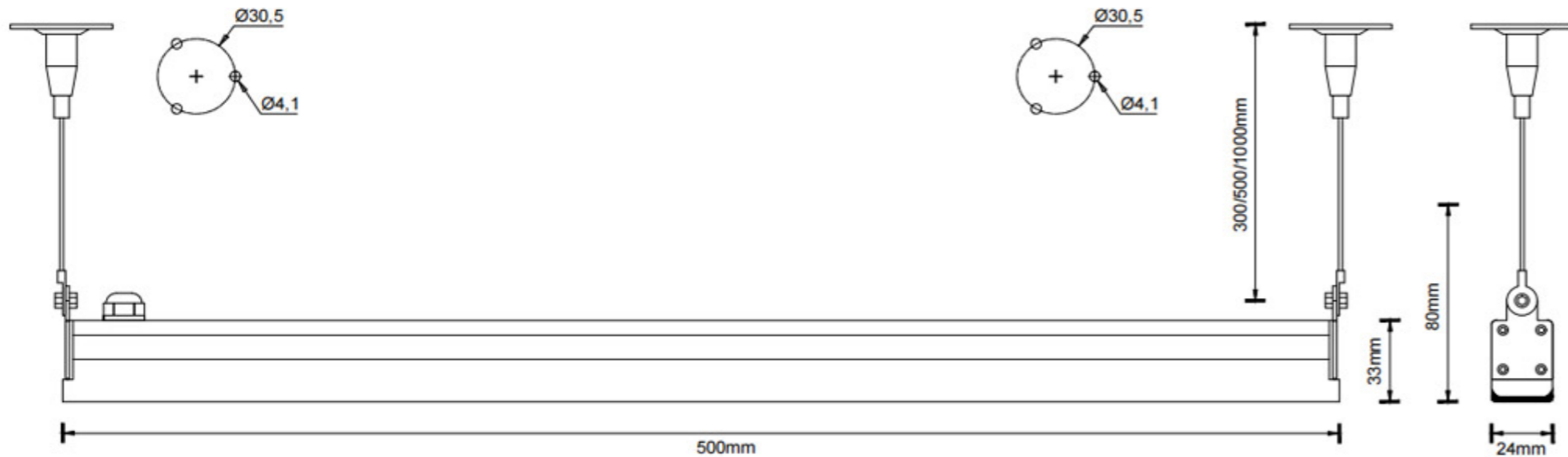

SS304 brackets surface mounted

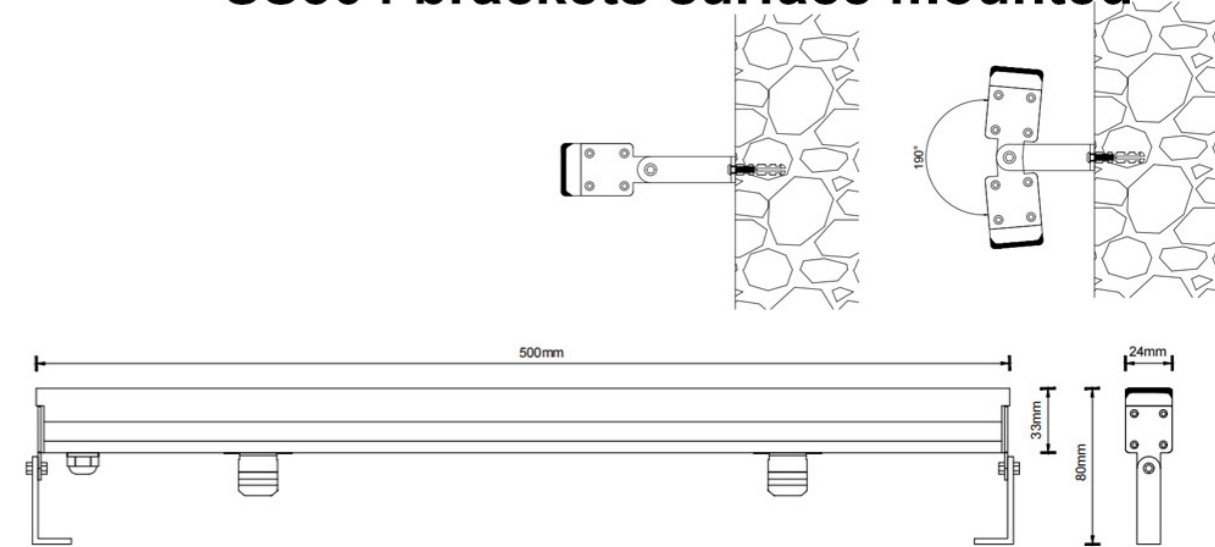

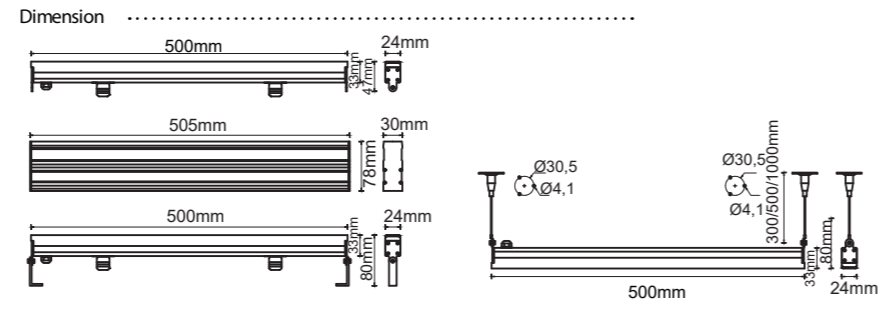

Light Distribution Curve (3000K, 200°)

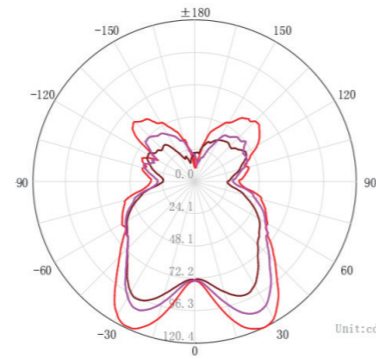

Lux distance Curve (3000K, 200°)

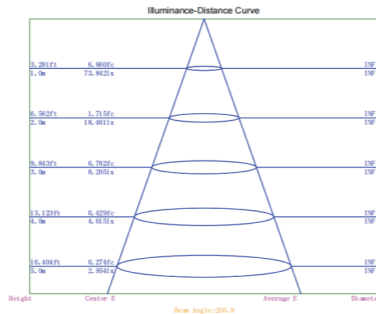

Illumination Picture (200°)

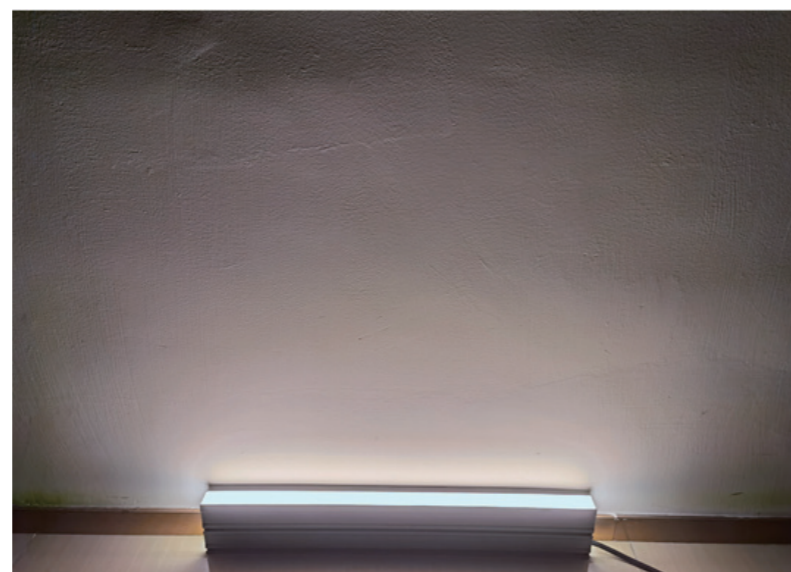

CE RoHS COMPLIANT IP67 IK08

3 Years Warranty

WALL LIGHTS SERIES

Parameter

General Data	
Item N o.	UL-C013-0900-A
Power	8.5 watts ±10%
LED type	48 PCS OSRAM 2835 SMD LED
Luminous flux	560 lm ±10%
CCT	2700K/3000K/4000K/5700K/6500K
CRI	80+
Beam angle	200°
Dimension	500*24*47 mm (Length x Width x Height)
Cut out	505*30*78 mm (Length x Width x Height)
Net weight	1.2 kgs
Warranty	3 years
Certifications	CE, RoHS
Electrical Data	
Input voltage	DC24V
Insulation class	Class III
Cable	1PC 1M H05RN-F 2*1mm ² rubber cable
Driver	constant current driver DC24V input
Construction Data	
IP rating	IP67 Waterproof
IK rating	IK08
Housing	Aluminium
Protection finishing	Anodizing in dark grey
Trim	Rimless
PMAA	clear +opal two colour PMMA
Loading capacity	350 kgs
Cable Gland	PG7
Gasket	Silicone gasket
Accessories	
Mounting Sleeve	Mounting box as inground light + SS304 taking out tool +end caps
Bracket	2PCS SS304 brackets for surface mounted
Rope	2PCS SS304 suspended rope for suspending installation
Packaging	
Inner box size	510*60*85mm
Carton size	53*32.5*17.5 cm (10PCS/CTN)

No dark areas between two LINEAR OPAL





成就未来

爱护花草
请勿采摘

