

LED基板上表面
Top surface of LED substrate

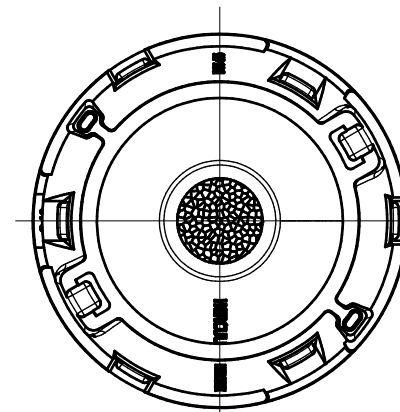
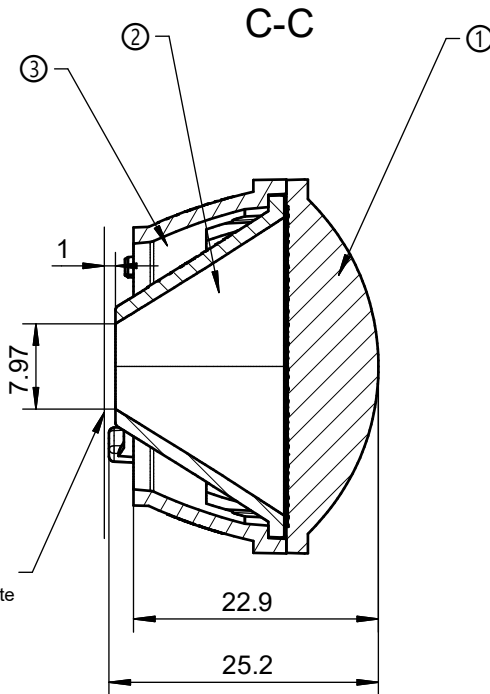

技术要求:

- 1、未注圆角及拔模斜度按3D图。
- 2、未注尺寸公差按右表。
- 3、表面无飞边，缩水，气泡等缺陷。
- *4、灯具采用胶圈防水时：要求散热器与胶圈的接触面的粗糙度：Ra<3.2μm

Technical remark:

- 1.Fillet and inclination not indicated according to 3D drawing.
2. Dimensional tolerances not indicated are shown in the right list.
3. The surface has no flash, shrinkage, bubbles and other defects.
- *4. When the lamp adopts rubber ring for waterproofing: the roughness of the contact surface between the radiator and the rubber ring is required: Ra<3.2μm

基本尺寸范围	公差值
Basic size	Tolerance value
<3	±0.1
3~10	±0.15
10~24	±0.20
24~65	±0.35
65~140	±0.50
140~250	±0.80
250~450	±1.2
>450	±2.0

序号 Item	物料编码 Part No.	产品名称 Title	产品编号 Drawing No.	材料 Material:	数量 quantity
①	1.01.33742_01	HK 萤火-麒麟 D35-24度透镜_01 HK Firefly-Kirin D35-24° Lens_01	HK-YHQL-35@09-1060-0	PMMA	1
②	1.01.33742_02	HK 萤火-麒麟 D35-反光杯_02 HK Firefly-Kirin D35-Reflective cup_02	HK-YHQL-32@16-1061-0	PC 镀铝 PC aluminizing	1
③	1.01.33742_03	HK 萤火-麒麟 D35-支架_03 HK Firefly-Kirin D35-holder_03	HK-YHQL-35@17-1062-S	PC黑色 PC black	1

出光角度范围 Beam angle range	透过率 Transmittance
最小K值 Min K value	点胶类型 Gel type
模具等级 Mold level	备注 Remark

2	4
1	3

序号 Item	更改标记 Change mark	更改内容 Change content	更改日期 Change date	签名 Signature	序号 Item	更改标记 Change mark	更改内容 Change content	更改日期 Change date	签名 Signature
光学设计 Optical design					Title:		Drawing No.		
结构设计 Structural design					HK 萤火-麒麟 D35-24度光学组件 HK Firefly-Kirin D35-24° optical module		HK-YHQL-35@25-24-D9-#0-1g-1_ASM		
审核 Verify							Part No. 1.01.33742		
审定 Approval					材料 Material:	组件 module	CDHK		