



**HERCULUX**  
恒坤光电

Chengdu HercuLux Photoelectric  
Technology Co.,Ltd  
**Product Approval**

Approval number:

Customer:

Product: HK DF80@L40 stretch film

Material Code 1.20.M0008 (Different product sizes have different material codes)

PN: HK-M-DF80@L40-PET25-LxW-O

Manufacturer: Chengdu HercuLux Photoelectric Technology Co.,Ltd



Supplier confirmation				Client confirmation			
Proposed		DATE		Qualified <input type="checkbox"/>		DATE	
Project manager		DATE		Unqualified <input type="checkbox"/>		DATE	
Audit		DATE		Audit		DATE	
Approved		DATE		Approved		DATE	
Stamp		DATE		Stamp		DATE	

(Confirmation of acceptance by both parties must be signed and sealed)

Factory: Chengdu Shuangliu District, lot industrial park 2 road HercuLux Photoelectric Park

Phone: 028-85887727 (801) 028-85887990 (801)

Fax: 028-85887730

<http://www.herculux.com/>

Sales Dept: Shenzhen Nanshan District Nanshan Cloud Valley Innovation Industrial Park Comprehensive Service Building,

TEL: 0755-2937 1541

FAX: 0755-2907 5140

\*Approval In duplicate, for both supplier and customer.

Please use this product within the permitted range and environment according to the structure and material of the product. If the usage exceeds the recommended value, please test and verify by yourself. If the product is damaged due to out-of-range use, our company will not be responsible for the warranty.

#### Product material:

Customized products: The specifications and models of materials used are subject to the agreement between the two parties.

Conventional products: As a product that we continuously research and improve, under the premise of ensuring the quality and availability of the product, our company reserves the right to change the material. If the material specification and model change, without prior notice.

#### product data:

The measurement data and dimensional tolerances of the 2D drawings in the product data sheet of this acknowledgement are for reference only, and the final size shall prevail in kind.

The measurement data presented in this acknowledgment is a performance test of the product based on our company's internal test conditions and quality requirements, and the reported data is a typical value of the average results of multiple measurements. Therefore, in some cases, the actual product may deviate from the data provided. We reserve the right to notify you in advance of this data.

#### Product changes and improvements:

Changes and improvements of customized products are subject to the agreement between the two parties in the contract or technical documents.

As the conventional products that we continue to research and improve, our company reserves the right to make technical changes to its products, and reserves the right to make changes to data resulting from improvements without prior notice.

#### Operation cautions:

1. Please wear clean gloves during product assembly to prevent product surface contamination.
2. Try to avoid touching the optical surface of the lens when taking the lens.
3. When the surface of the product is polluted, please wipe it gently with a soft cotton cloth dipped in analytically pure neutral solvent. It is forbidden to use industrial solvents (alcohol, isopropanol, acetone, ether, toluene, xylene, carbon tetrachloride, MMA monomer, etc.) wipe.
4. In the storage and use environment should not be exposed to direct sunlight. If the lens turns yellow or cracks due to long-term sunlight exposure, our company will not be responsible for the warranty.



Product Picture:	
Size(L*W*H/Φ*H):	L*W*0.3
Material:	PET25+Optical adhesive
Bending radius:	5mm
Temperature(Topr):	Material extreme temperature resistance: -30°C to +80°C
Ultraviolet resistance:	f1
Fire rating:	\

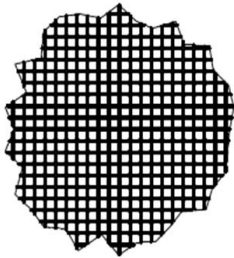
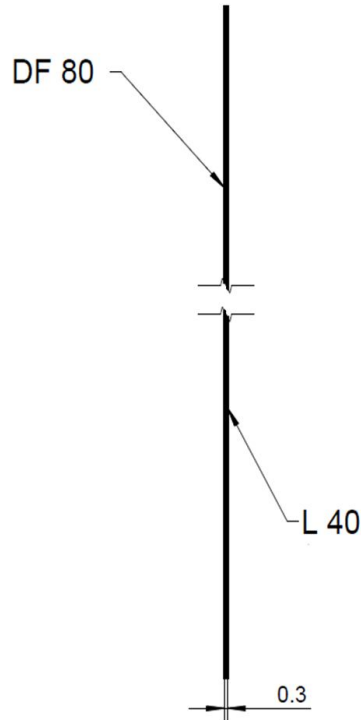
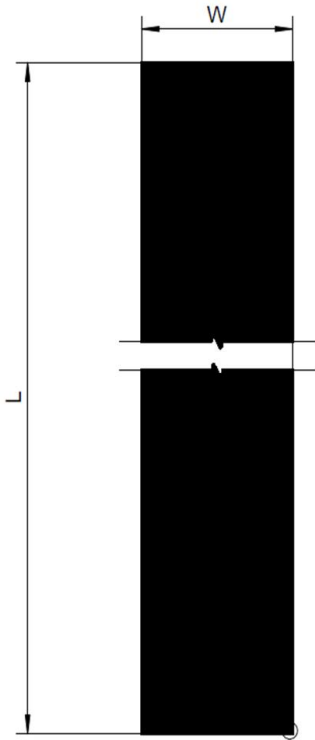

膜微结构面示意  
Membrane microstructure plane

幅宽最大: 1200mm  
breadth MAX: 1200mm



Technical remark:

1. The 3D map is not indicated for rounded corners and draft angle.
2. The dimensional tolerances are not specified according to GB/T 14486 2008 MT5.
3. The surface has no flash, shrinkage, bubbles and other defects.
- \*4. When the lamp adopts rubber ring for waterproofing: the roughness of the contact surface between the radiator and the rubber ring is required:  $Ra < 3.2 \mu m$

Note: The L and W dimensions of this product can be customized according to customer needs, the corresponding product L and W dimensions are different, the material code and product model are different.

MT5 Tolerance table (mm)	Basic size	<3	3~10	10~24	24~65	65~140	140~250	250~450	>450
	Tolerance value	±0.1	±0.15	±0.2	±0.35	±0.50	±0.80	±1.2	±2.0
	Optical design			HK DF80@L40 stretch film			HK-M-DF80@L40-PET25-LxW-O		
	Structure design						1.20.M0008 (Different product sizes have different material codes)		
	Review						Number of drawings	qty	weight
	Validation						Material:	PET25+Optical adhesive	CDHK

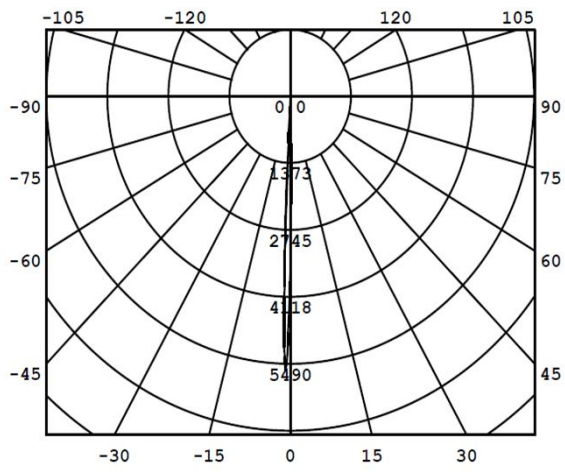
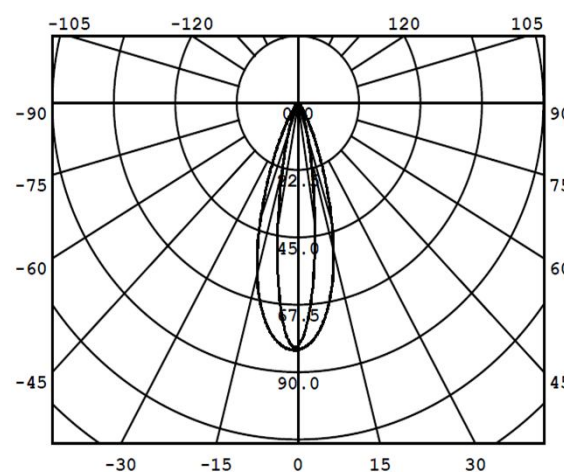
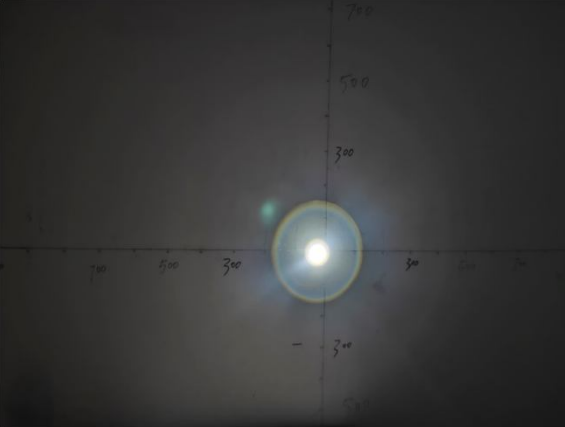
material	PET25+Optical adhesive	
Test luminaire	Use Hengkun fluorescent series line lights, basic Angle 20x60 degrees	
	Test data	
	membraneless	membranous
angle	20.0° x59.5°	41.3° x53.8°
Efficiency	87%	
	membraneless	membranous
Distribution curve		
factogram		

material	PET25+Optical adhesive	
Test luminaire	Test with a small Angle light	
	Test data	
	membraneless	membranous
angle	2.6°	19.3° X37°
	membraneless	membranous
Distribution curve		
factogram		

The luminaire is 2.8M high and the desktop is 1m high

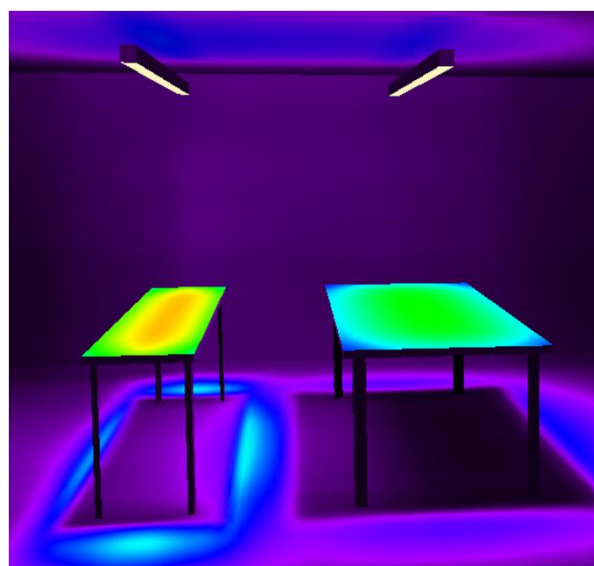
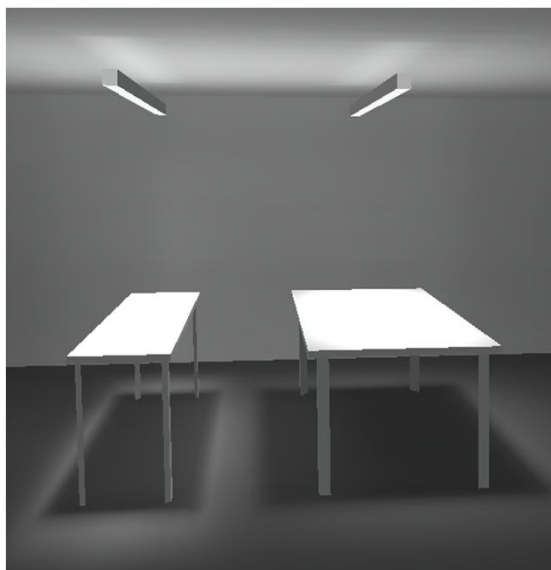

The line light without film can only shine at 0.7m wide desktop, plus 40° film can shine at 1.2m wide desktop