



Approval number:

Customer:

Manufacturer: Chengdu HercuLux Photoelectric Technology Co.,Ltd

PN	Code	Product
HK-JZ-50@10-100X60-5050-#0-1g-4	1. 02. 33550	HK Matrix 4in1-100X60° Lens

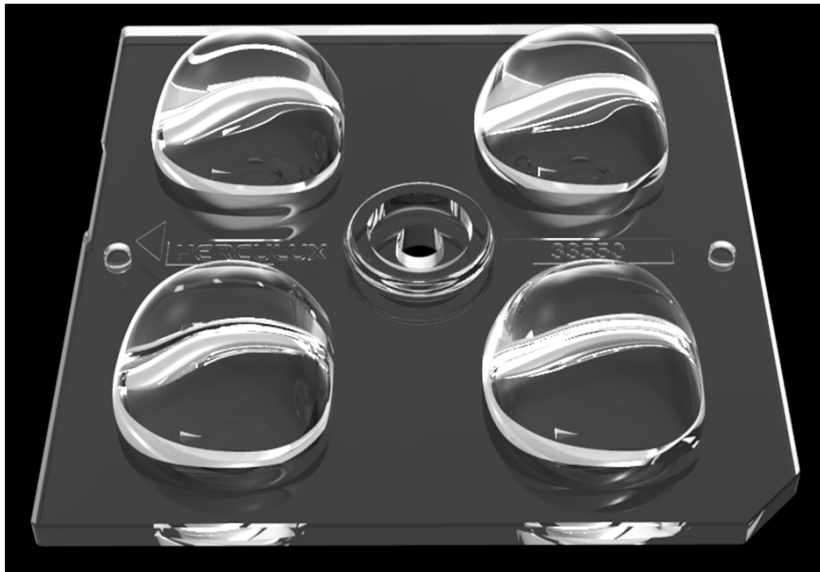

Supplier confirmation				Client confirmation			
Proposed		DATE		Qualified <input type="checkbox"/>		DATE	
Project manager		DATE		Unqualified <input type="checkbox"/>		DATE	
Audit		DATE		Audit		DATE	
Approved		DATE		Approved		DATE	
Stamp		DATE		Stamp		DATE	

(Confirmation of acceptance by both parties must be signed and sealed)

Factory: Chengdu Shuangliu District, lot industrial park 2 road HercuLux Photoelectric Park

Phone: 028-85887727 (801) 028-85887990 (801)

Fax: 028-85887730

<http://www.herculux.com/>

Sales Dept: Shenzhen Nanshan District Nanshan Cloud Valley Innovation Industrial Park Comprehensive Service Building, 501-505

TEL: 0755-2937 1541

FAX: 0755-2907 5140

\*Approval In duplicate, for both supplier and customer.

Please use this product within the permitted range and environment according to the structure and material of the product. If the usage exceeds the recommended value, please test and verify by yourself. If the product is damaged due to out-of-range use, our company will not be responsible for the warranty.

#### Product material:

Customized products: The specifications and models of materials used are subject to the agreement between the two parties.

Conventional products: As a product that we continuously research and improve, under the premise of ensuring the quality and availability of the product, our company reserves the right to change the material. If the material specification and model change, without prior notice.

#### product data:

The measurement data and dimensional tolerances of the 2D drawings in the product data sheet of this acknowledgement are for reference only, and the final size shall prevail in kind.

The measurement data presented in this acknowledgment is a performance test of the product based on our company's internal test conditions and quality requirements, and the reported data is a typical value of the average results of multiple measurements. Therefore, in some cases, the actual product may deviate from the data provided. We reserve the right to notify you in advance of this data.

#### Product changes and improvements:

Changes and improvements of customized products are subject to the agreement between the two parties in the contract or technical documents.

As the conventional products that we continue to research and improve, our company reserves the right to make technical changes to its products, and reserves the right to make changes to data resulting from improvements without prior notice.

#### Operation cautions:

1. Please wear clean gloves during product assembly to prevent product surface contamination.
2. Try to avoid touching the optical surface of the lens when taking the lens.
3. When the surface of the product is polluted, please wipe it gently with a soft cotton cloth dipped in analytically pure neutral solvent. It is forbidden to use industrial solvents (alcohol, isopropanol, acetone, ether, toluene, xylene, carbon tetrachloride, MMA monomerm,etc.) wipe.
- 4.The lens made of PC should not be exposed to direct sunlight in the storage and use environment. If the lens turns yellow or cracks due to long-term sunlight exposure, our company will not be responsible for the warranty.



**HERCULUX**  
恒坤光电

# Basic product information

TEL: 0755-2937 1541

FAX: 0755-2907 5140

<http://www.herculux.com/>

Date updated: 2024/7/15

Product Picture:	
Size(L*W*H/Φ*H):	L50mm*W50mm*H: 9.67mm
Material:	PC
Efficiency:	\
Temperature(Topr):	Material extreme temperature resistance: -40°C to +120°C long-term use temperature: -40°C to +100°C
FWHM:	100°X60°
Matched LES:	5050
Recommended MAX power:	

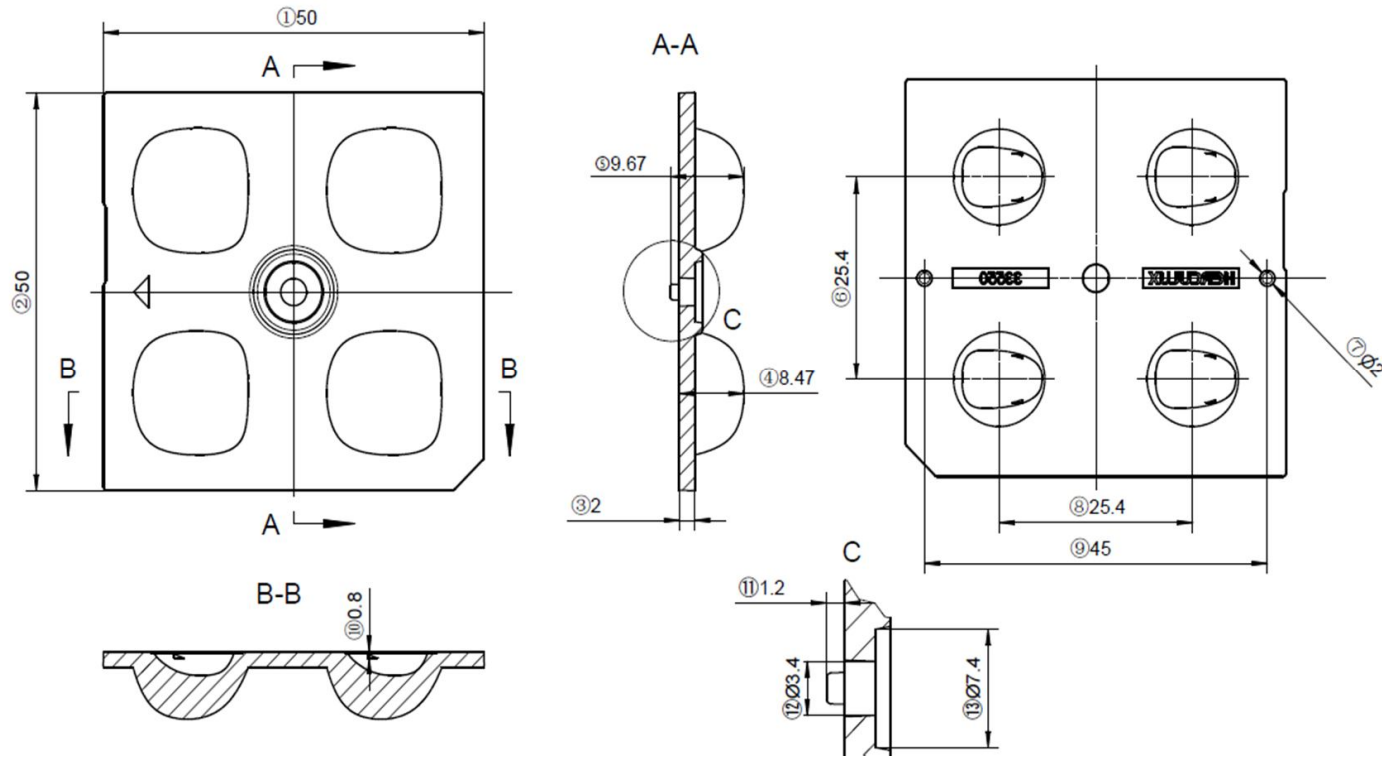

**Technical remark:**

1. The 3D map is not indicated for rounded corners and draft angle.
2. The dimensional tolerances are not specified according to GB/T 14486 2008 MT5.
3. The surface has no flash, shrinkage, bubbles and other defects.
- \*4. When the lamp adopts rubber ring for waterproofing: the roughness of the contact surface between the radiator and the rubber ring is required: Ra<3.2μm

Optical design			HK Matrix 4in1-100X60°Lens		HK-JZ-50@10-100X60-5050-#0-1g-4		
Structure design					1.02.33550		
Review					number of drawing	qty	weight
Validation					CDHK		
			Material:	PC			

MT5 Tolerance table (mm)	Basic size	<3	3~10	10~24	24~65	65~140	140~250	250~450	>450
	olerance valu	±0.1	±0.15	±0.2	±0.35	±0.50	±0.80	±1.2	±2.0

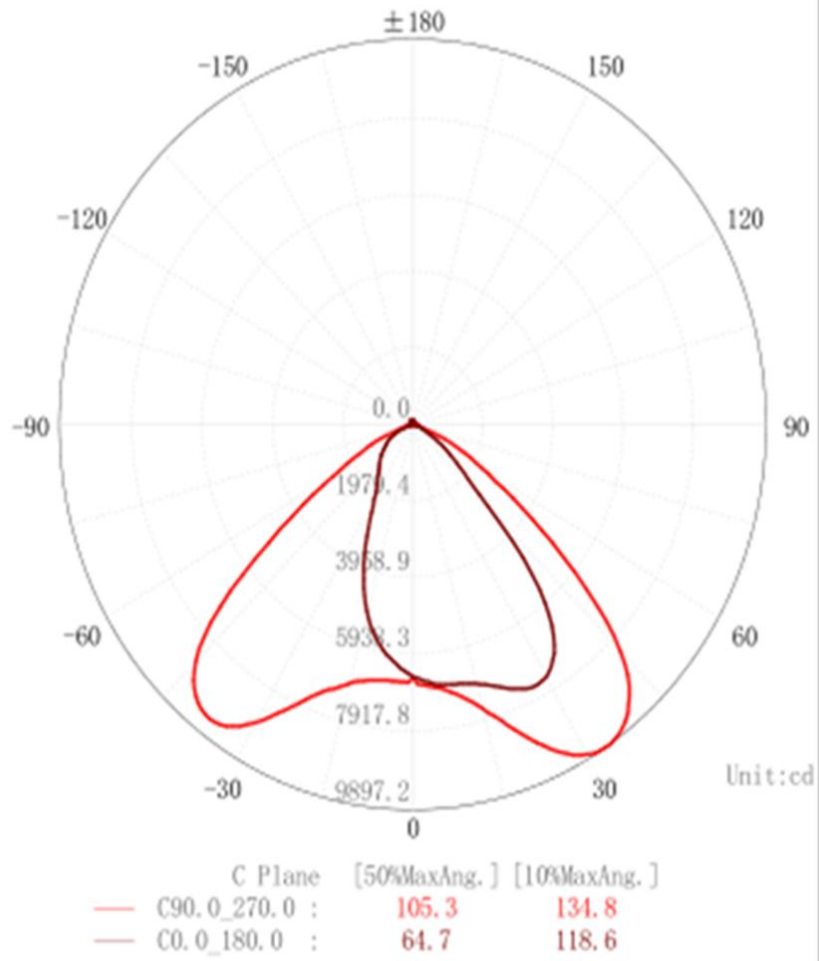

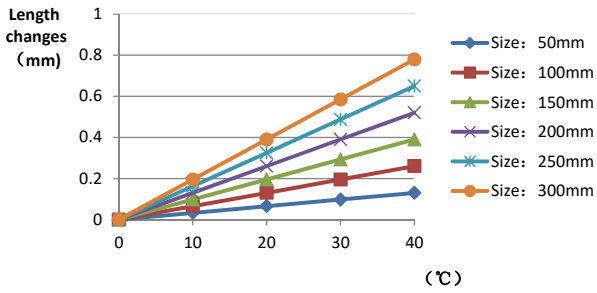
	Standard size	Upper Size limit	Lower size limit	Test result 1	Test result 2	Test result 3	Test result 4	Test result 5	Test result 6	Test result 7	Test result 8	Judgment	Remarks																																										
1.Size	length	50			49.9	49.9	49.9	50	50	49.9	49.9	49.8	Test environment: In 20 °C -25 °C environment to achieve thermal equilibrium after the test.																																										
	breadth	50			49.9	49.9	50	49.9	50	49.9	49.8	49.8																																											
	thickness	2			2.02	2.02	2.01	2.02	2.02	2.03	2.03	2.02																																											
Gate shear can not affect the appearance of the lamp																																																							
See attachment "Appearance Inspection Standards"																																																							
2.Appearance Quality	See attachment "Appearance Inspection Standards"	E	No burr									No burr	OK																																										
			No stains											No stains																																									
3.Material	PC											Color	OK																																										
4.Optical index	Testing LED	5050																																																					
	The size and rated power of the light-emitting surface (LES) of the COB recommended by this lens should conform to the parameters in the product basic information table. If it is required to be out of range. According to the heat dissipation capability of the lamp and the actual conditions of the use environment, the lens should be fully tested and tested to prevent the lens life.																																																						
	FWHM	See light distribution curve																																																					
	angle (50%)		105.3*																																																				
	angle (10%)		64.1																																																				
	K-value (CD/LM)																																																						
Efficiency																																																							
Facula	See the signature sample																																																						
Comprehensive judgment	Qualified																																																						
Remarks:	<p>1、 Tool Number: V-Vernier Caliper 2D-Quadratic H-Height Gauge M-Tool Microscope P-Needle T-Thick Gauge R-Radius Gauge E-Visual.</p> <p>2、 Ambient temperature on the size of the product refer to the table on the right</p>																																																						
	<p style="text-align: center;"><b>PC product size changes with temperature table</b></p>  <table border="1"> <caption>Data for PC product size changes with temperature table</caption> <thead> <tr> <th>Temperature (°C)</th> <th>Size: 50mm</th> <th>Size: 100mm</th> <th>Size: 150mm</th> <th>Size: 200mm</th> <th>Size: 250mm</th> <th>Size: 300mm</th> </tr> </thead> <tbody> <tr> <td>0</td> <td>0.00</td> <td>0.00</td> <td>0.00</td> <td>0.00</td> <td>0.00</td> <td>0.00</td> </tr> <tr> <td>10</td> <td>0.05</td> <td>0.10</td> <td>0.15</td> <td>0.20</td> <td>0.25</td> <td>0.30</td> </tr> <tr> <td>20</td> <td>0.10</td> <td>0.20</td> <td>0.30</td> <td>0.40</td> <td>0.50</td> <td>0.60</td> </tr> <tr> <td>30</td> <td>0.15</td> <td>0.30</td> <td>0.45</td> <td>0.60</td> <td>0.75</td> <td>0.90</td> </tr> <tr> <td>40</td> <td>0.20</td> <td>0.40</td> <td>0.60</td> <td>0.80</td> <td>1.00</td> <td>1.20</td> </tr> </tbody> </table>													Temperature (°C)	Size: 50mm	Size: 100mm	Size: 150mm	Size: 200mm	Size: 250mm	Size: 300mm	0	0.00	0.00	0.00	0.00	0.00	0.00	10	0.05	0.10	0.15	0.20	0.25	0.30	20	0.10	0.20	0.30	0.40	0.50	0.60	30	0.15	0.30	0.45	0.60	0.75	0.90	40	0.20	0.40	0.60	0.80	1.00	1.20
Temperature (°C)	Size: 50mm	Size: 100mm	Size: 150mm	Size: 200mm	Size: 250mm	Size: 300mm																																																	
0	0.00	0.00	0.00	0.00	0.00	0.00																																																	
10	0.05	0.10	0.15	0.20	0.25	0.30																																																	
20	0.10	0.20	0.30	0.40	0.50	0.60																																																	
30	0.15	0.30	0.45	0.60	0.75	0.90																																																	
40	0.20	0.40	0.60	0.80	1.00	1.20																																																	
Precautions:	<p>1. Please wear clean gloves during the lens assembly process to prevent the lens surface from being contaminated.</p> <p>2. Try to avoid touching the total reflection surface when taking the lens.</p> <p>3. The lens surface is contaminated. Only use a soft cotton cloth dipped in analytically pure neutral solvent to wipe gently. Do not wipe with industrial solvents (alcohol, isopropanol, acetone, ether, toluene, xylene, carbon tetrachloride, MMA Body, etc.).</p> <p>4. The working temperature of the lens should be within the temperature resistance limit of the lens material. Exceeding the temperature resistance limit will cause the lens to crack or melt and affect the service life of the lens. It is recommended that the upper surface temperature of the LED colloid should be less than 120 degrees.</p>																																																						

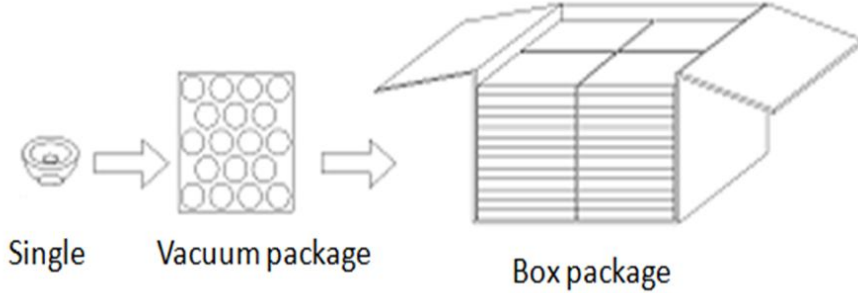
PN		HK-JZ-50@10-100X60-5050-#0-1g-4		Product Name			
Product material		PC					
Package diagram		 <p style="text-align: center;">Single      Vacuum package      Box package</p>					
Product packing		24	A/ Box	4	pcs/Layer		
		14	Layer/Box	1344	A/ Carton		
Packaging Materials	NO.	Part No	Part name	Size	Dosage	Unit	Remarks
	1	2.07.0097	Blister box	23cm*21cm	56	BAG	
	2	2.08.0001	PE film	25cm*27cm	56	PCS	
	3	2.06.0005	Reel label paper	62mm*42mm	56	PCS	
	4	2.06.0005	Box label paper	62mm*70mm	1	PCS	
	5	2.06.0003	big plate	46cm*42cm	15	PCS	
	6	2.06.0011	big flat carton	48cm*44cm*37cm	1	PCS	
Remarks	The loose packing is not subject to this specification. Customer's requirements shall prevail						

## Special notice

When glue pass through holes, columns and other structures, or part of the thin structure, will form a weld line. The product which uses multi-point injection welding line will appear because of the combination of sol, as shown below:

## Synthesis

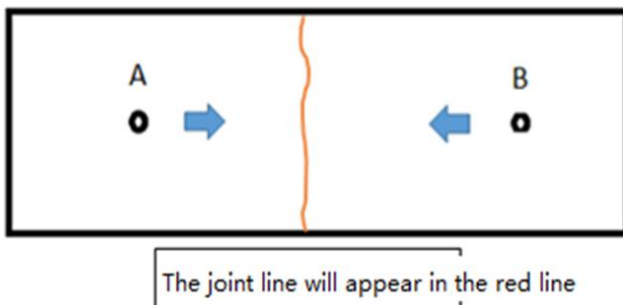
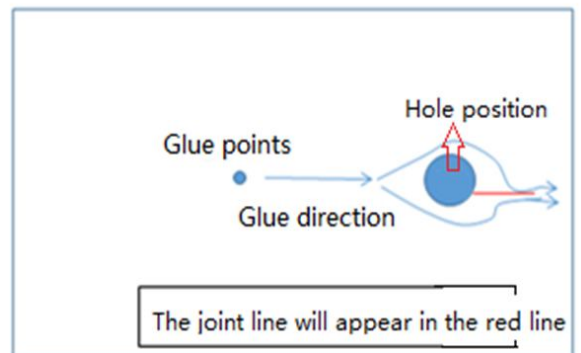
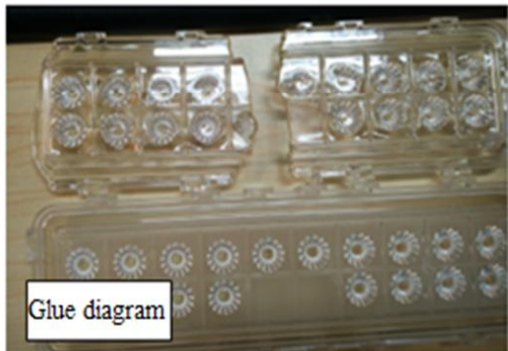
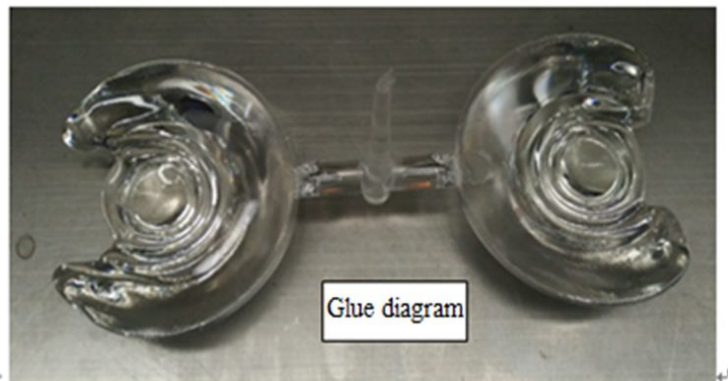
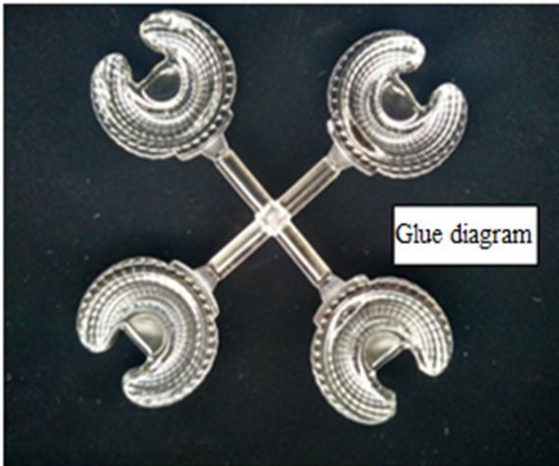

Please note:

The appearance of lines in the structure of the product as well as at the screw hole is a normal phenomenon, will not affect the actual use of the product, and can not be avoided at this stage.

## Appearance inspection standards

### 1 Operating procedures

#### 1.1.1 Sampling standards, sampling plan and AQL

Test level: GB/T2828.1-2012 The first part is according to the acceptance quality limit (AQL) retrieval batch inspection sampling plan, general inspection level II level, CR class defect coefficient 0, MA defect rejection level AQL = 0.65, MI class defect rejection level AQL = 1.0; defect level please see 5.4.

### 2 Code table

Code	Code description	Unit	Code		Code description	Unit
N	Amount/pcs	pcs	D		Diameter	mm
L	Length	mm	H		Depth	mm
W	Width	mm	DS		Distance	mm
S	Proportion	mm <sup>2</sup>	SS		Offset	mm

### 3 Test conditions

3.1 Sight distance and working hours: Sight distance should be 30-35cm, each side of the inspection time does not exceed 12s, the visual angle of 45-135 degrees;

3.2 Light: 2x40w cool white fluorescent lamp, the light source is 500-550mm away from the lens surface; in order to make the appearance defect can be correctly recognized, the illumination should be 500-1000Lux, and the observation time is 10 seconds.

3.3 Visual inspection staff should be 1.0 (including corrected visual acuity) above, no color blindness, color weakness.

### 4 Appearance inspection standards

Test items	Judging standard	Inspection equipment	Defect level		
		Testing method	MI	MA	CR
Check the sample	When start the machine and process, all products have to check the appearance of the sample, the appearance of the sample is divided into qualified samples and limited samples.	Sample comparison , visual			
	1: Qualified sample refers to the appearance and structure standard of the product which recognized by the client, the sample size should be confirmed before mass production;				

	2: The limited sample refers to the limit of a particular exceptionally developed sample. Limit the sample only for its specific point of exception to confirm; The priority is higher than the other criteria in this table. When there is a limited sample, the limit sample shall prevail.				
Raw edge	Not allowed to affect the size and assembly	Visual, point card		√	
Scratch	1: Non-optical surface and non-exposed surface scratches should be visually insignificant and the length is less than 1/10 of the maximum surface size.	Visual, point card, calipers		√	
Fingerprint	Fingerprints are not allowed on all products	Visual		√	
Foreign objects, black spots, white spots	The product may not be attached to foreign objects, including oil, fiber, dregs of water gap and so on				√
Deformation	Insufficient filling shall not affect the appearance of the assembly and the exposed surfaces.	Visual, feeler			√
Poor ejection	Products may not appear bad ejection, including no convex top, thimble printed on the assembly surface shall not be higher than the product surface, non-assembled surface thimble height should not exceed the product size tolerances; thimble printing should be less than the product surface and no more than 0.3; thimble surface treatment should be consistent with the product side.	Visual, point card		√	
	Ejection strain: the optical surface and the appearance of the exposed surface after assembly are not allowed to have a strain, and the structural surface does not allow visual obvious strain.				
Insufficient filling	Insufficient filling shall not affect the appearance of the assembly and the exposed surfaces, The signature sample shall prevail.	Visual, point card		√	
Shrink	When the entire surface of the product shrinks, the optical properties and dimensions must meet the requirements, and the visual will not significantly affect the appearance. Part shrink reference point defects	Visual, point card		√	
Flow marks, Welding line	1: Product does not allow the presence of flow marks and welding lines unless the structure can not be avoided;	Visual		√	
	2: The remaining flow marks shall not appear in the optical surface, a single $L \leq 10\text{mm}$ , no more than two				

Bubble	No bubbles are allowed	Visual		√	
Foreign objects, black spots, white spots	Not obvious or $D \leq 0.3\text{mm}$ black spots and foreign bodies in the area of 100x100mm not more than 1; Exceeded foreign matter black spots is judged bad.	Visual, point card	√		
Damaged	No damage is allowed	Visual			√
Cold glue	Optical surface may not have cold glue, non-optical surface cold glue should meet the visual is not obvious.	Visual	√		
Bad incision	1: Do not affect the product size, shall not penetrate the optical surface, the cut should be smooth;	Visual			√
	2: Laser cutting products, the optical surface burns shall not occur after the processing is completed. Beading must not affect product installation				
	3: Three molds and hot runner gate shall not appear residue.				
Scrub	Scrub surface should be uniform, off the scrub phenomenon should not be obvious , A single off scrub imprint requires $D \leq 1\text{ mm}$ and no more than 1 area within a 50x50 mm area	Visual		√	