

# MAXILLUM Product Directory

---



Control Systems ..... 1~12



Lighting Source ..... 13~17



Recessed Type ..... 18~24



ABS Wall Mounted ..... 25~48



Stainless Steel Wall Mounted ..... 49~65



MINI / 1.5 inch / 2.0 inch ..... 66~84



Underwater + Fountain Light ..... 85~89



Accessories ..... 90~92

# 01

## Control Systems

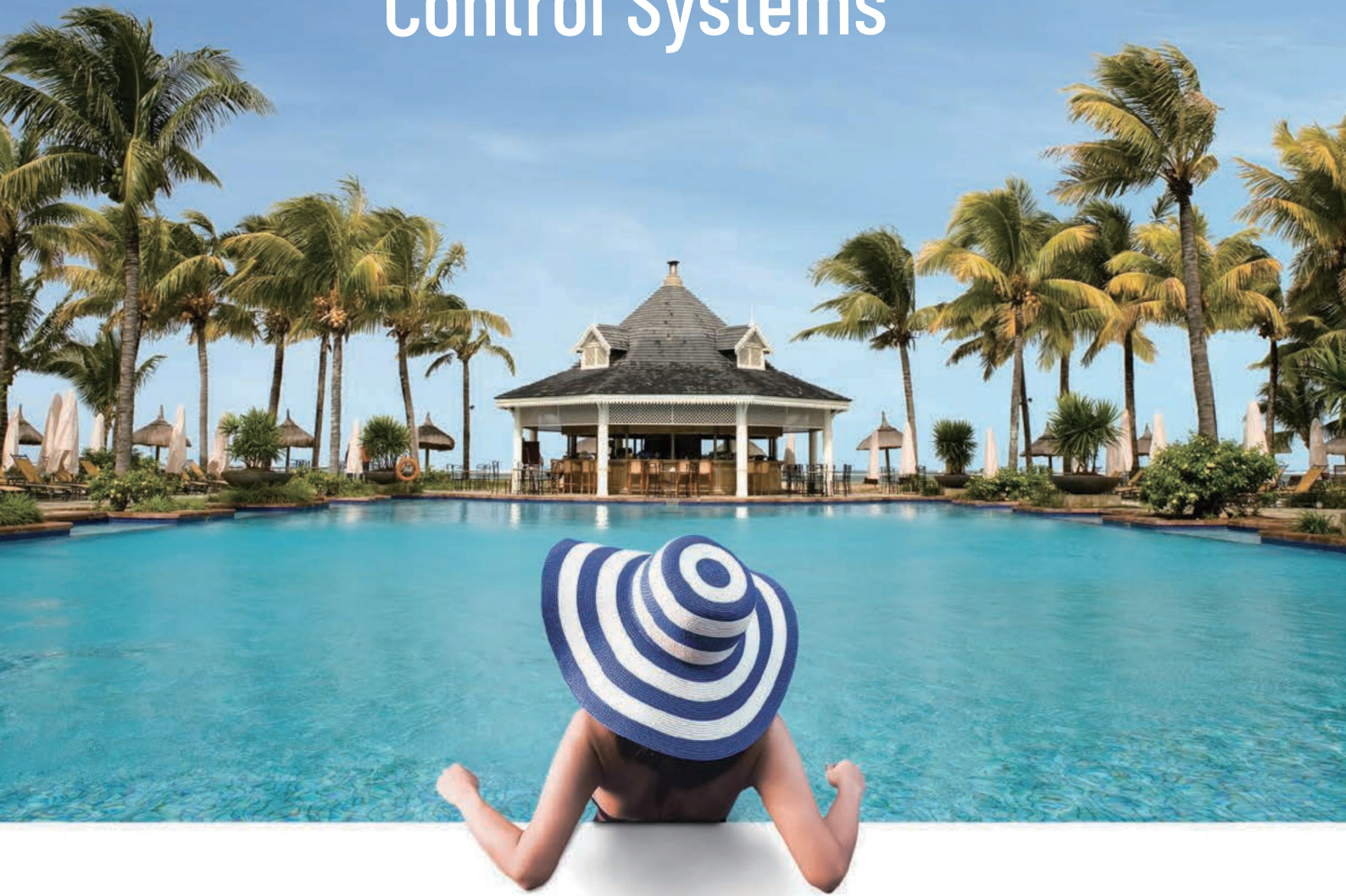

Control Box , with a remote controller  
RGBW Swimming Pool Light WiFi Control System MC-14 Pro  
Remote Control  
Music + RGB Lighting synchronized control,by WiFi Mobile Phone

# Control Box , with a remote controller

15 Color Programs, see Page 3

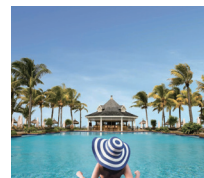

**Code : CB006**

Size : 150\*105\*70mm

6 connect terminals ,max 120W.



**Remote controller**



**Code : CB008**



Size : 185\*175\*110mm

8 connect terminals ,max 300W.

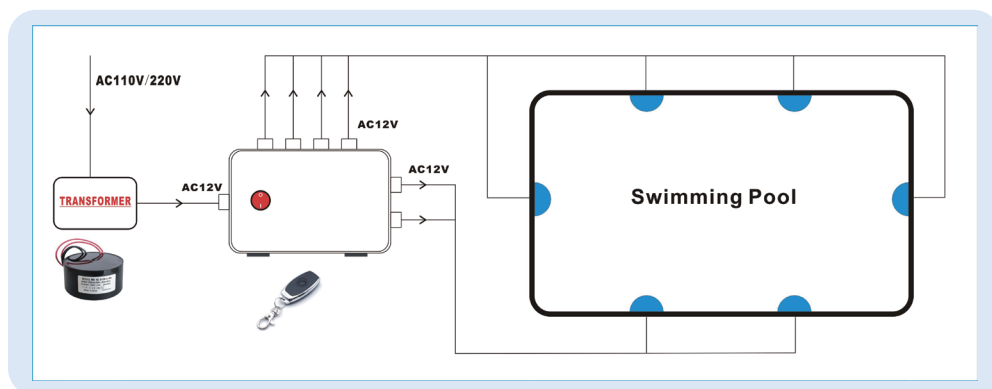
## How to connect the lamps with the CB box ?



- Connecting all lights absolutely synchronized.
- 15 color models to meet personal enjoyment.
- Handle remote controller can be 30-50 meters far from the control box.
- This MINI box must be connected with the magnetic transformer(AC12V).
- **You can change the lamps' color by main switch or remote controller.**

PHOTO	CODE	INPUT	POWER	POSITION	CONNECT LAMP QTY	
	CB006	AC12V	120W	After the Transformer	RGB 12W	6pcs
					RGB 18W	5pcs
					RGB 25W	4pcs
					RGB 32W	3pcs
					RGB 40W	2pcs
	CB008	AC12V	300W	After the Transformer	RGB 12W	8pcs
					RGB 18W	8pcs
					RGB 25W	8pcs
					RGB 32W	6pcs
					RGB 40W	6pcs

# Control Box , with a remote controller

15 Color Programs, see Page 3

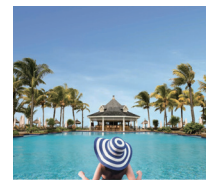

Remote controller

Code : CB004-1000W

Size : 220\*140\*75mm

4 connect terminals ,max 1000W.

- Connecting all lights absolutely synchronized.
- 15 color models to meet personal enjoyment.
- Handle remote controller can be 30-50 meters far from the control box.
- This MINI box must be connected **before** the magnetic transformer(AC220V).
- **You can change the lamps' color by main switch or remote controller.**

## How to connect the lamps with the CB box ?

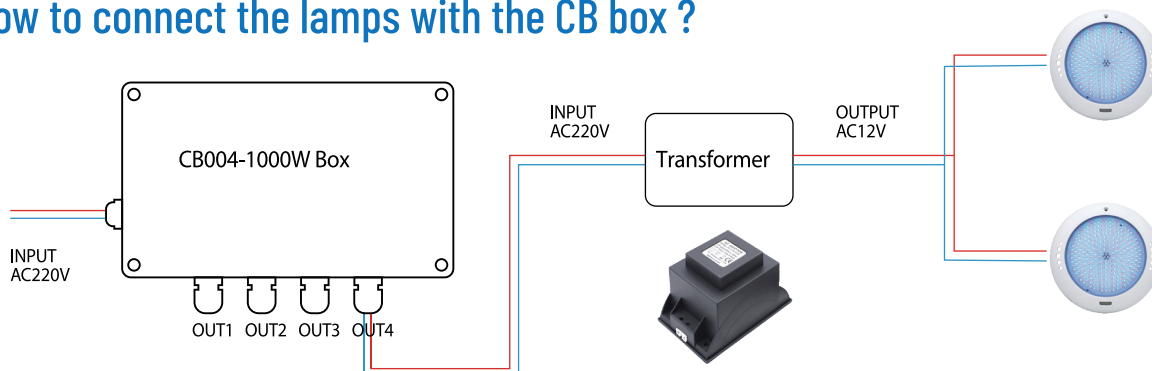

PHOTO	CODE	INPUT	POWER	POSITION	CONNECT LAMP QTY	
	CB004-1000W	AC 220V	1000W	Before the Transformer	RGB 12W	60pcs
					RGB 18W	50pcs
					RGB 25W	30pcs
					RGB 32W	25pcs
					RGB 40W	20pcs

## 1. ON/OFF Control 15 Color Programs

- 1 Static Blue
- 2 Static Red
- 3 Static Green
- 4 Static Red/Blue
- 5 Static Blue/Green
- 6 Static Red/Green
- 7 Static White
- 8 Cycle Red-Red/Green-Green
- 9 Cycle Green-Green/Blue-Blue
- 10 Cycle Red-Red/Blue-Blue
- 11 Cycle Red-Green-Blue,Speed from fast to low.
- 12 Same as program 11, the speed is slower.
- 13 Cycle Green-Red/Blue-Blue-Red-White-Blue/Green-Red/Green
- 14 Cycle gradual change of all colors.
- 15 Cycle gradual change of Red-Green-Blue.



### Operation

#### Changing colors:

Turn the lamps OFF and quickly back ON (0-3 seconds)

#### Synchronizing multiple lamps:

1. All lamps need to be connected to the same transformer.
2. Turn the lamps OFF and back ON within 4-30 seconds.
3. All the lamps back to first program ( static blue )

#### Memorizing the last color:

Select the desired color, turn OFF the lamps more than 34 seconds, the chosen color has now been memorized.

# RGB/RGBW Swimming Pool Light WiFi Control System MC-14 Pro Controller



## Maxillum Controller Parameters

Size: 165\*110\*73mm

Input: AC 120V / AC 220V

Output: AC 120V / AC 220V

Max Power: 400W



download the  
TUYA or Smart Life APP



supports voice  
control via smart speaker



Access the operating  
interface to set a timer

## How to connect the lights with the Controller ?

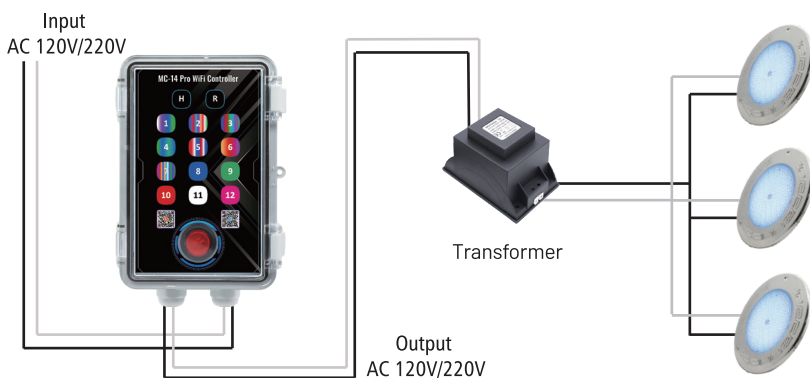

INPUT: Right terminal Black / White Cable  
OUTPUT: Left terminal Black / White Cable

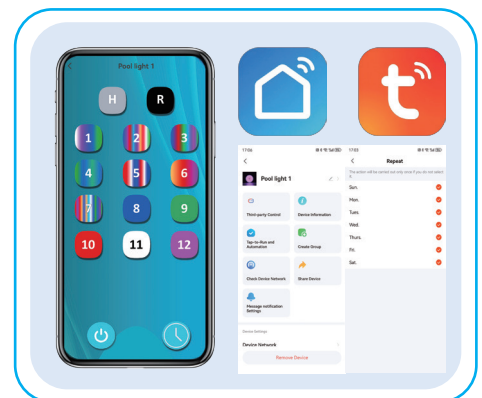

# RGB/RGBW Swimming Pool Light WiFi Control System MC-14 Ultra Controller

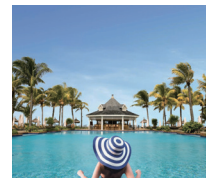

## 01 Instant Multi-Mode Access | Offline/Emergency Use

### Dual Physical Control

- WiFi Control Panel: Direct operation without internet or smartphone—switch between 12 BF effects (including "H/R" special functions) instantly with zero delay.
  - R18 Remote Control: Quick access to 12 BF modes, adjustable brightness and speed, ideal for home/party lighting.
- Solves scenarios like no network, phone unavailable, or urgent lighting adjustments.

## 02 Smart APP Ecosystem | Customization & Entertainment

### Full-Scene Customization

- 16 million colors with picker tool + fine-tuned brightness for professional-grade color needs.
- Built-in festive scenes (Birthday/Christmas/Halloween, etc.) for one-tap ambiance.
- Built-in BF Model, 12 programs (same as panel control and remote control)

### Smart Interaction

- Music Sync: Real-time microphone audio reactivity—lights dance to music (perfect for parties/KTV).
- Voice Control: Works with mainstream smart assistants (e.g., Alexa, Google Assistant).
- Scheduling: Set auto on/off timers for energy savings.

### H/R Exclusive Features

- (H) Hold: In the show models, tap H to lock the current color, creating a 6th static color instantly.
- (R) Return: Hold R to flash back to the last locked static color.

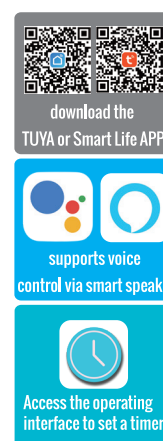
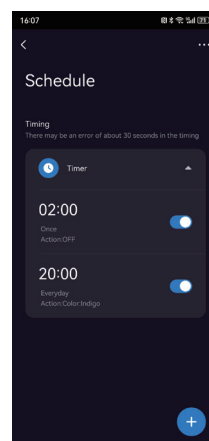
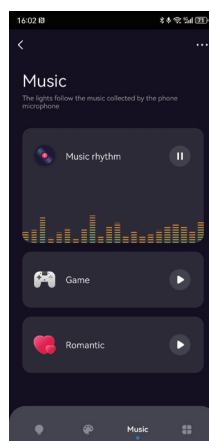
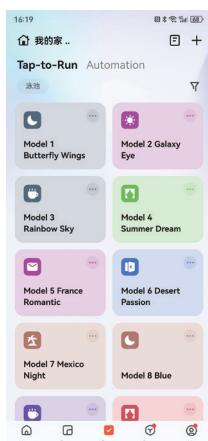
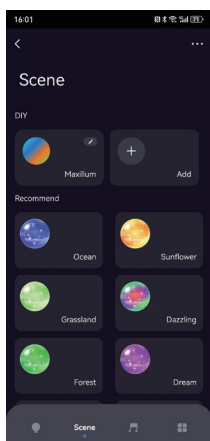
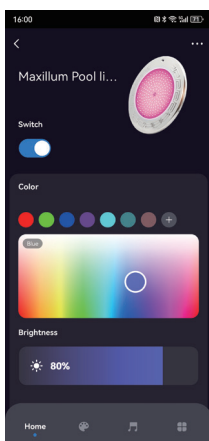

# RGB ON/OFF Control Box MC-14

12 Color Programs, see Page 7



The MC-14 can be installed in American wall switch socket installation bottom box.



## How to connect the lamps with the MC-14 box ?

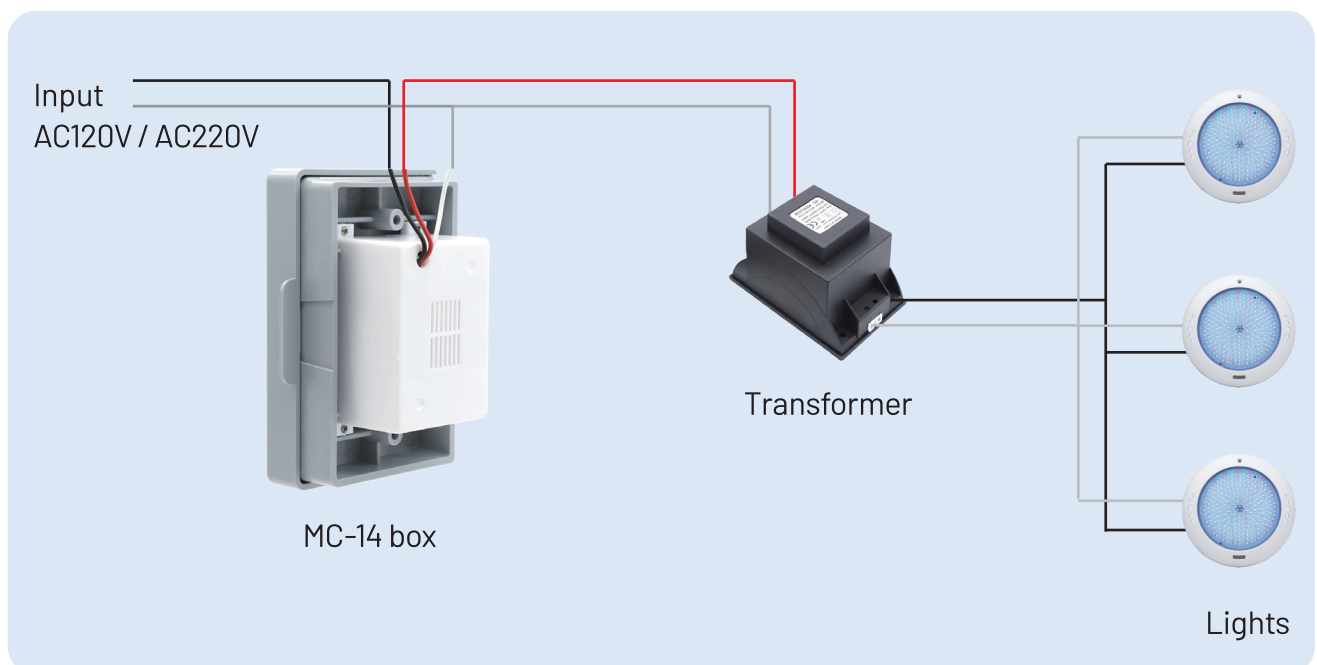

# Remote Control



## A-13 Color Programs



R14

(Controlling Distance Max 100M)

- 1 Static Blue
- 2 Static Red
- 3 Static Green
- 4 Static Red/Blue
- 5 Static Blue/Green
- 6 Static Red/Green
- 7 Static White
- 8 Cycle Red-Red/Green-Green
- 9 Cycle Green-Green/Blue-Blue
- 10 Cycle Red-Red/Blue-Blue
- 11 Cycle Red-Green-Blue, Speed from fast to low.
- 12 Cycle Green-Red/Blue-Blue-Red-White-Blue/Green-Red/Green
- 13 Cycle gradual change of all colors.

Superhet Remote controller + Signal terminal out of water = Perfect Synchronization

### Operation

#### Changing colors:

Button 1-13, each button is one program.

#### Synchronizing multiple lamps:

Press one button until all the lamps change to the same program.

#### Memorizing the last color:

Select the desired color, turn OFF the lamps, the chosen color has now been memorized.

For PAR56 bulb

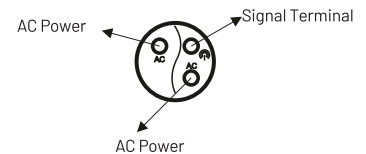

For wall mounted lamp



Signal wire(G&Y cable)

Blue and brown wire are AC power

## B-12 Color Programs



R18

- 1 **Butterfly Wings** : Cycles through white, purple, blue and green colors
- 2 **Galaxy Eye** : The colors flash quickly, full of energy
- 3 **Rainbow Sky** : Gradual change blue-purple-red-yellow-cyan-green-purple
- 4 **Summer Dream** : Blue and green appear alternately
- 5 **France Romantic** : Transition between red, white and blue
- 6 **Desert Passion** : Dramatic transitions of orange, red and purple
- 7 **Mexico Night** : Richer and deeper color changes between red-purple-yellow-green
- 8 **Ocean Heart** : Static Blue
- 9 **Spring Green** : Static Green
- 10 **Cherry Kiss** : Static Red
- 11 **Noble White** : Static White
- 12 **Lavender Love** : Static Purple

### Operation

ON/OFF : Turn ON / Turn OFF the light

B+/B- : Brightness adjustable      S+/S- : Speed adjustable

Mode : Short press 12 models cycles, long press reset to BLUE color

## 2. Remote Control



### C-3 Color Programs (Only for WW&WHT lamps)

- 1 ON/OFF
- 2 Warm White
- 3 Cool White
- 4 Cool White and Warm White Combined
- 5 Brightness-
- 6 Brightness+

### Remote Control

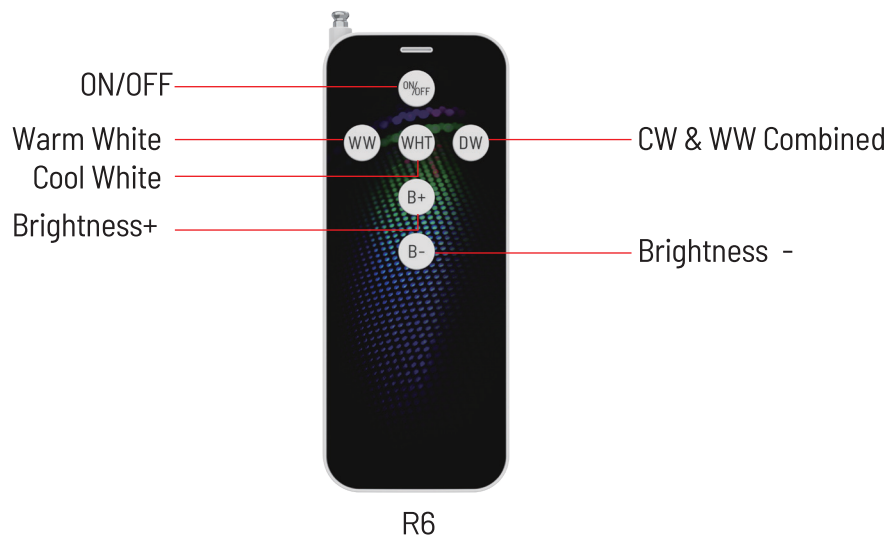

### Operation

To change the color or sequence, switch off/on the supply(AC12V) or by remote controller. The lamp has memory. That means the equipment will save the cycle it was doing. When turn on next time, the equipment will start from this cycle.

### 3. Music + RGB Lighting synchronized control, by WiFi Mobile Phone



Light with 4 wires

DC12V



For Android & iOS

Code : WiFi CB004

Size : 185\*175\*100mm

4 connect terminals ,max 150W.

- 1) Support Android system and IOS system
- 2) Remote control LED lights by App (Magic Home) at anywhere
- 3) Support timing function; set schedule to switch on/off lights
- 4) Lighting color change with the rhythm of music in your smart device
- 5) Work with Google Assistant, Amazon Alexa, control your lights by voice

#### Controlling the RGB Lighting and Music Synchronize Together

In this function, you can let shine the connected LED in the rhythm of the music will be played on the smartphone or tablet. To do this, select the menu item "select music" and then select your music library on smartphone or tablet the desired music.

There are four main modes for four music styles:

1. ROCK for rock & roll music style,
2. NORMAL for default music style,
3. JAZZ for jazz music style,
4. CLASSICAL for classical music style.

IOS system needs to download music files in iTunes or copy audio files from computer's iTunes to iPhone. After then, you can select the music when you open APP music mode to synchronize the lights and music rhythm. The light color changes automatically with music rhythm.

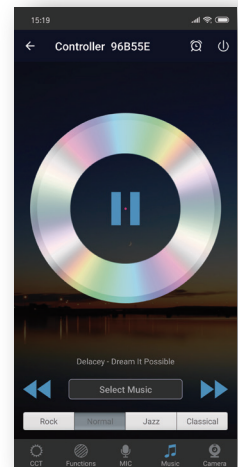

Android system needs to download the music files to the phone for use



Europe Plug

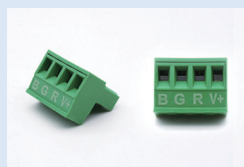

Connector



Power Supply



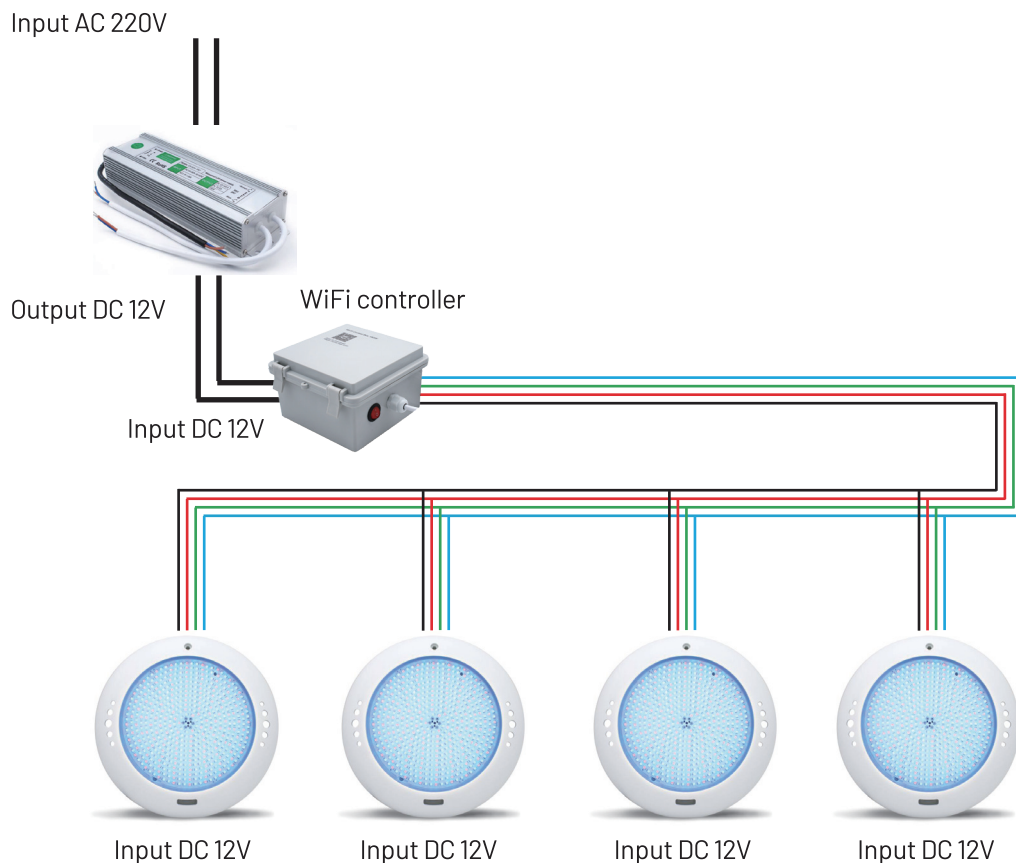
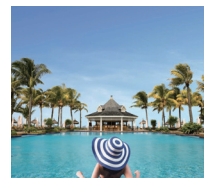

4 Wires Pool Light

# How to connect the lamps with the WiFi CB box ?



**The RGB lights which connected with the Wifi CB004 box must be 4 wires, DC12V**

PHOTO	CODE	INPUT	POWER	POSITION	CONNECT LAMP QTY	
	WiFi CB004	DC12V	150W	After the Transformer	RGB 12W	4pcs
					RGB 18W	4pcs
					RGB 25W	4pcs
					RGB 32W	3pcs
					RGB 40W	2pcs
	WiFi CB008	DC12V	300W	After the Transformer	RGB 12W	8pcs
					RGB 18W	8pcs
					RGB 25W	8pcs
					RGB 32W	6pcs
					RGB 40W	6pcs

## 4. RGBW External Remote Control



Light with 5 wires DC12V

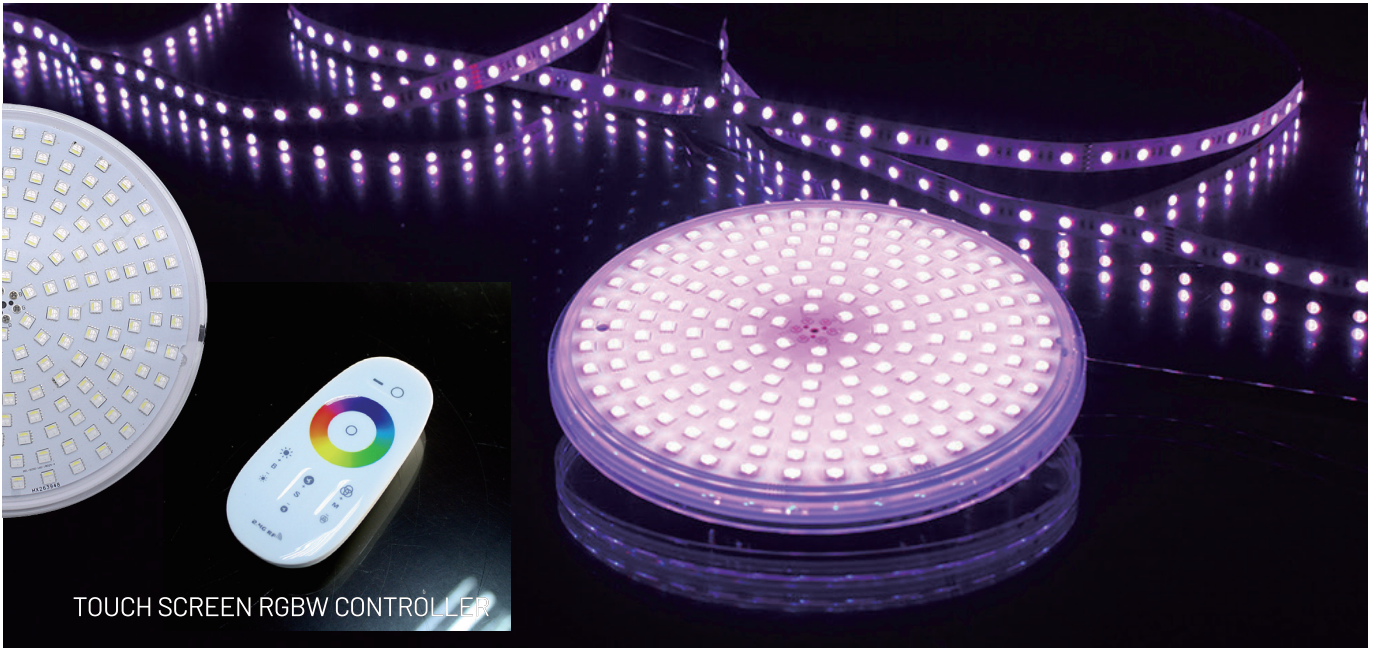

TOUCH SCREEN RGBW CONTROLLER

- IP68 Waterproof
- Stronger body, never broken
- Beautiful out-looking

### How to connect the lamps with the controller ?

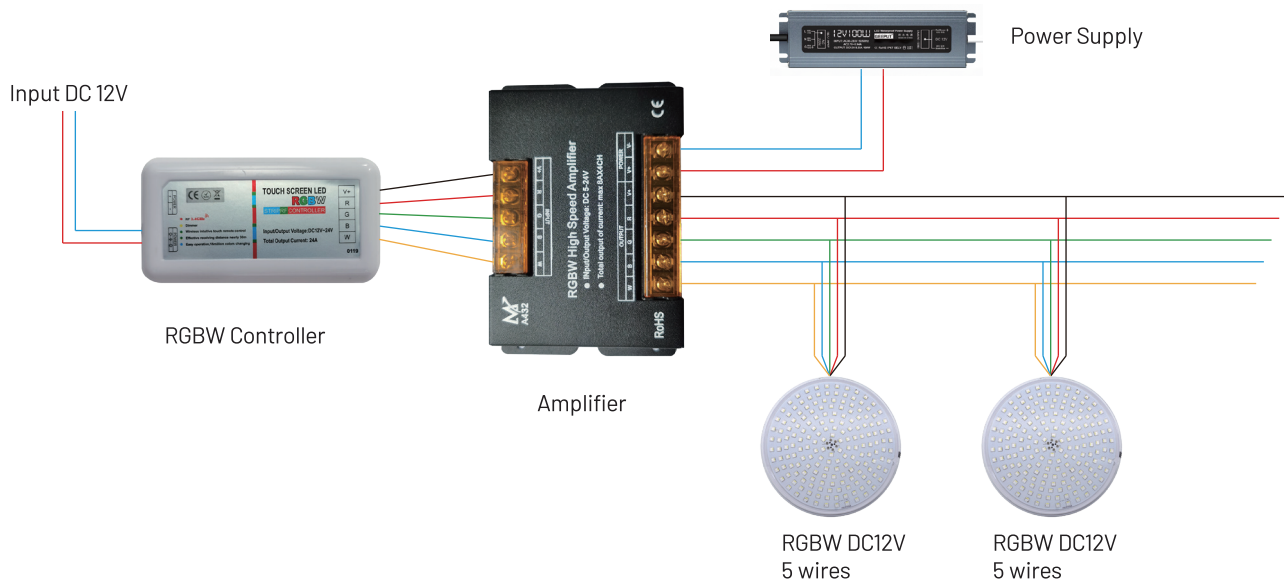

# 4. RGBW External Remote Control



## Remote Interface



	<b>ON/OFF</b> Turn ON/OFF the light and the controller
	<b>Color Wheel</b> Select the LED light color
	<b>Signal indicator light</b> RED Light means the Remote send signal
	<b>Brightness Adjust Button</b> Change the LED brightness by clicking the buttons
	<b>Speed Adjust Button</b> In Dynamic Mode, increase/decrease the changing speed
	<b>Modes Select Button</b> Select the Modes by clicking the button

## RGBW Program

No.	Mode	Note	No.	Mode	Note
1	W+ Color Ring	Brightness Adjustable	8	G/W Jumping	Brightness Speed Adjustable
2	W Static		9	B/W Jumping	
3	7 Colors Gradient	Brightness Speed Adjustable	10	R Flashing	
4	R G B W Breathing		11	G Flashing	
5	R G B W Jumping		12	B Flashing	
6	7 Color Jumping		13	W Flashing	
7	W R Jumping		14	Loop mode(1-14)	

