

Features

- Rated Power: 0.25W
- Single-turn
- Precision Adjustable
- Reliable Performance
- Small Size
- High Precision

Product Dimensions

Top Adjust

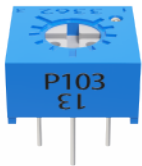

3362P

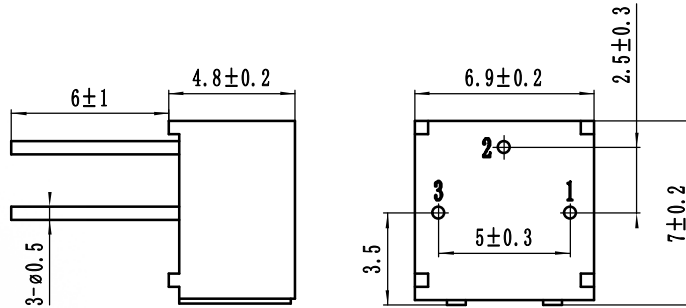

Terminal Spacing on a 2.54 PCB

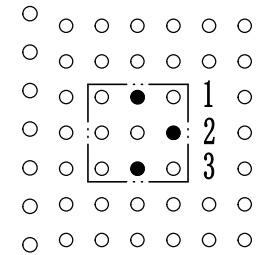

DIMENSIONS: MM
TOLERANCES: ±0.3 MM EXCEPT WHERE NOTED

Top Adjust



3362P-EY3

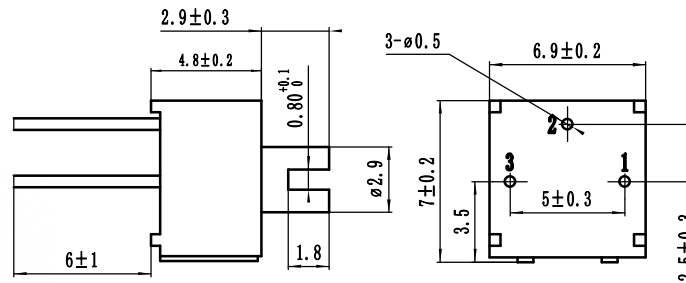

Terminal Spacing on a 2.54 PCB

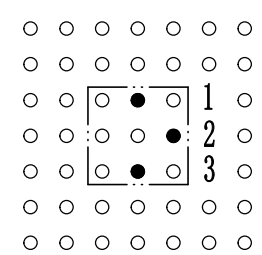

DIMENSIONS: MM
TOLERANCES: ±0.3 MM EXCEPT WHERE NOTED

Top Adjust



3362P-T1

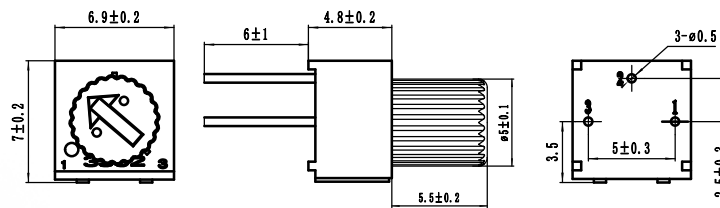

Terminal Spacing on a 2.54 PCB

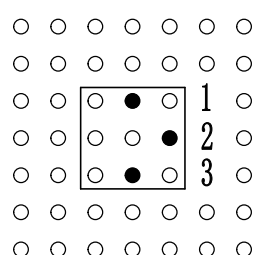

DIMENSIONS: MM
TOLERANCES: ±0.3 MM EXCEPT WHERE NOTED

Top Adjust



3362P-T2

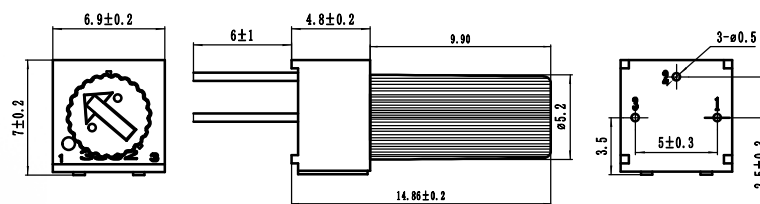

Terminal Spacing on a 2.54 PCB

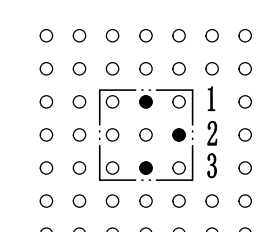

DIMENSIONS: MM
TOLERANCES: ±0.3 MM EXCEPT WHERE NOTED

Product Dimensions

Top Adjust



3362U

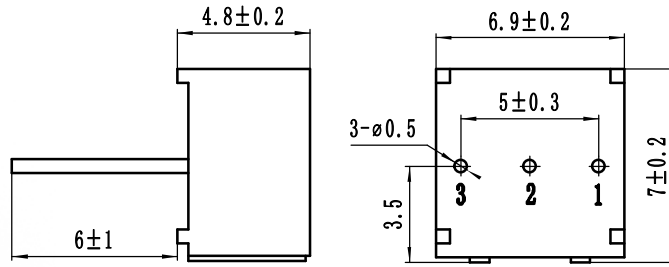

Terminal Spacing on a 2.54 PCB

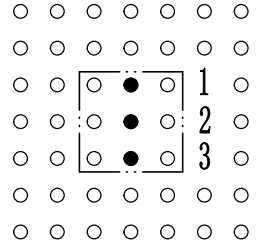

DIMENSIONS: MM
TOLERANCES: ±0.3 MM EXCEPT WHERE NOTED

Top Adjust



3362H

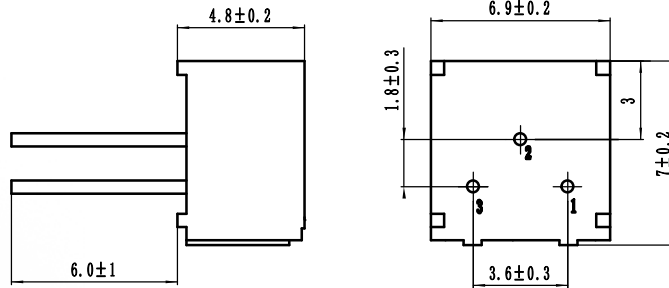

Terminal Spacing on a 1.8 PCB

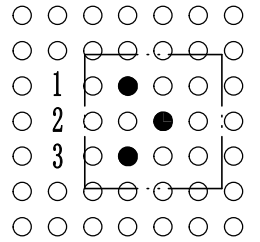

DIMENSIONS: MM
TOLERANCES: ±0.3 MM EXCEPT WHERE NOTED

Top Adjust



3362R

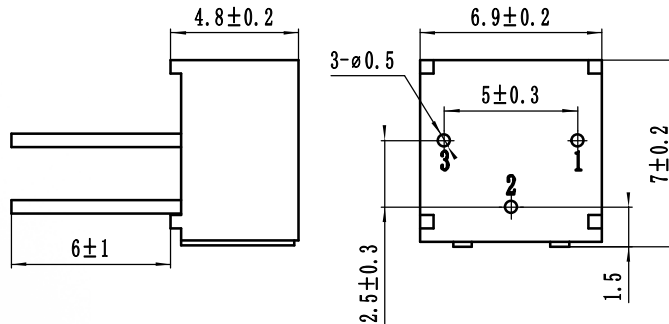

Terminal Spacing on a 2.54 PCB

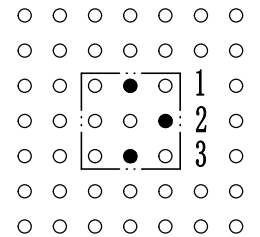

DIMENSIONS: MM
TOLERANCES: ±0.3 MM EXCEPT WHERE NOTED

Side Adjust

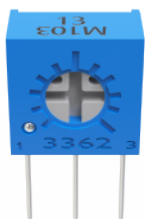

3362M

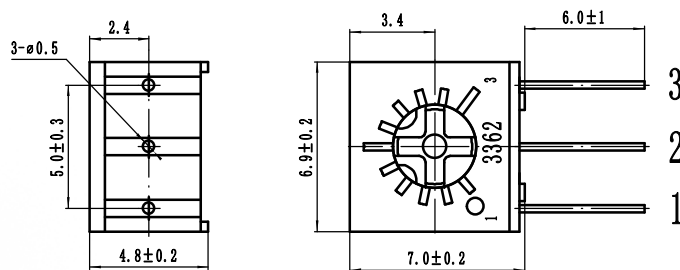

Terminal Spacing on a 2.54 PCB

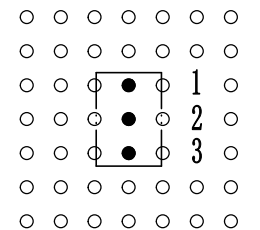

DIMENSIONS: MM
TOLERANCES: ±0.3 MM EXCEPT WHERE NOTED

Product Dimensions

Side Adjust

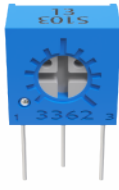

3362S

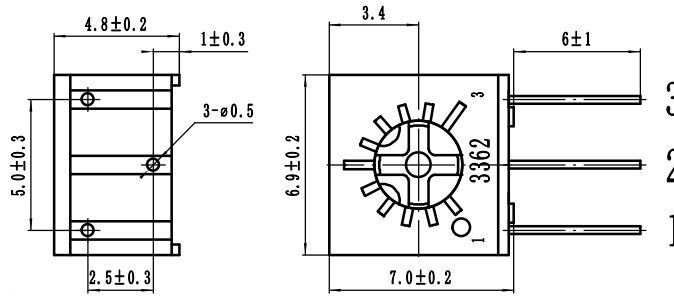

Terminal Spacing on a 2.54 PCB

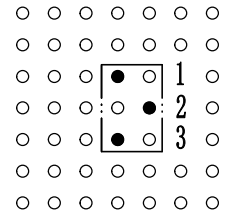

DIMENSIONS: MM
TOLERANCES: ±0.3 MM EXCEPT WHERE NOTED

Side Adjust

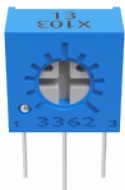

3362X

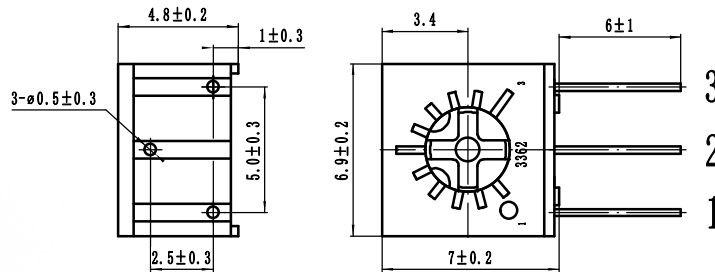

Terminal Spacing on a 2.54 PCB

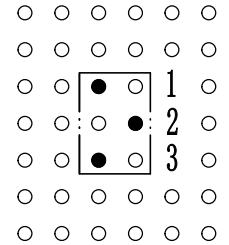

DIMENSIONS: MM
TOLERANCES: ±0.3 MM EXCEPT WHERE NOTED

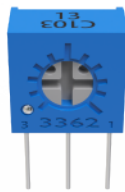

3362C

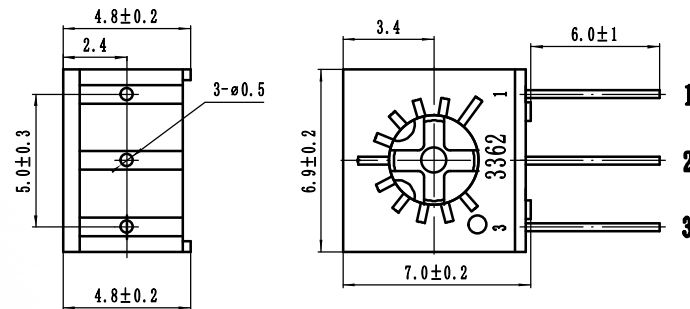

Terminal Spacing on a 2.54 PCB

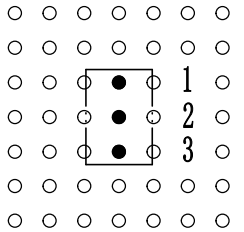

DIMENSIONS: MM
TOLERANCES: ±0.3 MM EXCEPT WHERE NOTED

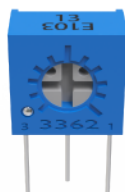

3362E

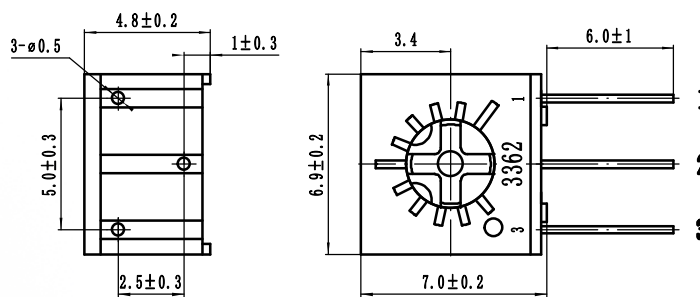

Terminal Spacing on a 2.54 PCB

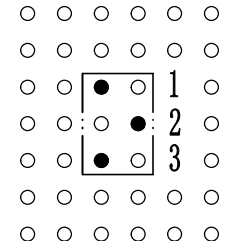

DIMENSIONS: MM
TOLERANCES: ±0.3 MM EXCEPT WHERE NOTED

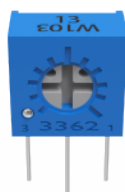

3362W

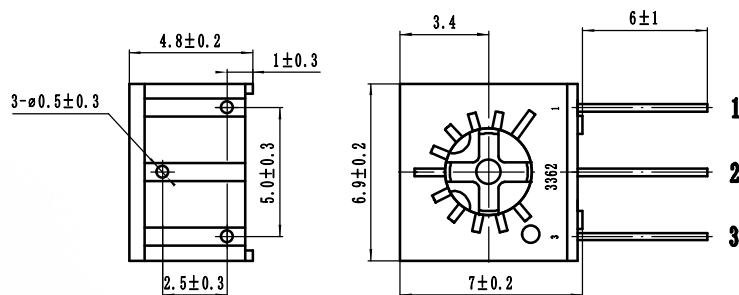

Terminal Spacing on a 2.54 PCB

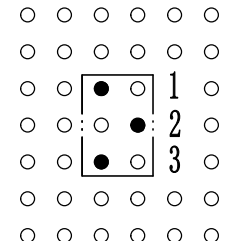

DIMENSIONS: MM
TOLERANCES: ±0.3 MM EXCEPT WHERE NOTED

Electrical Characteristics

Items	Parameters
Standard Resistance Range	10Ω-5MΩ
Resistance Tolerance	±10%
End Resistance	≤±1% R or 3Ω
Contact Resistance Variation	≤3%R or 3Ω
Insulation Resistance	500 Vdc. 100megohms min.
Withstanding Voltage	101.3KPa, 500 Vac; 8.5KPa, 250 Vac
Dielectric Strength Sea Level	500 Vac (1 minute)
Adjustment Angle	220°

Environmental Characteristics

Items	Parameters
Max. Soldering Exposure	250°C , 10 seconds
Power Rating(300 volts max.)	70°C, 0.25W; 125°C, 0W
Operating Temp. Range	-55°C ~ + 125°C
Temperature Coefficient	±250、±100 ppm /°C
Temperature Variation	ΔR≤±3%R, Δ(Uab/Uac) ≤±1%
Vibration	20G, ΔR≤±1%R, Δ(Uab/Uac) ≤±1%
Shock	100G, ΔR≤±1%R, Δ(Uab/Uac) ≤±2%
70°C Electrical Endurance	1000 hours @ 70°C Rated Power; ΔR≤±3%R
Rotational Life	200 cycles、ΔR≤±3%R

Physical Characteristics

Items	Parameters
Mechanical Angle	250°
Starting Torque	≤25 mN.m
Stop Strength	≤35 mN.m
Standard Packaging	50 pieces/tube

Standard Resistance Table

Resistance(Ohms)	Resistance Code
10	100
20	200
50	500
100	101
200	201
500	501
1,000	102
2,000	202
5,000	502
10,000	103
20,000	203
50,000	503
100,000	104
200,000	204
500,000	504
1,000,000	105
2,000,000	205

How to Order

