

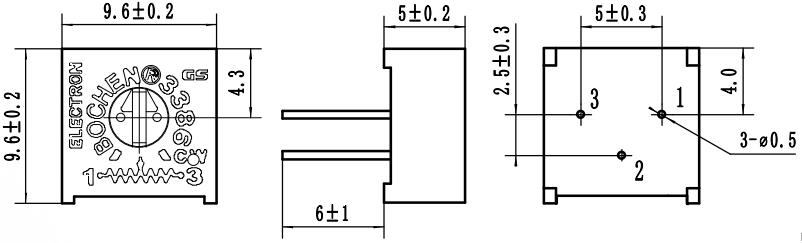

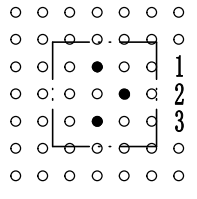



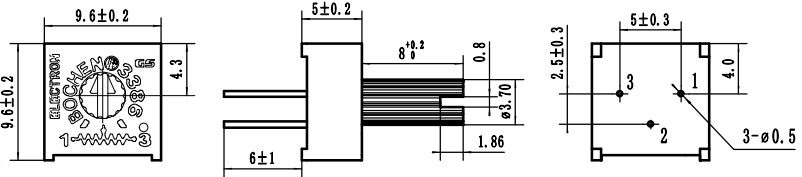
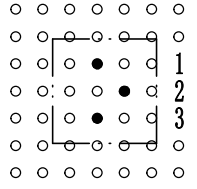

Features

- Rated Power: 0.5W
- Single-turn
- Precision Adjustable
- Reliable Performance
- Small Size
- High Precision

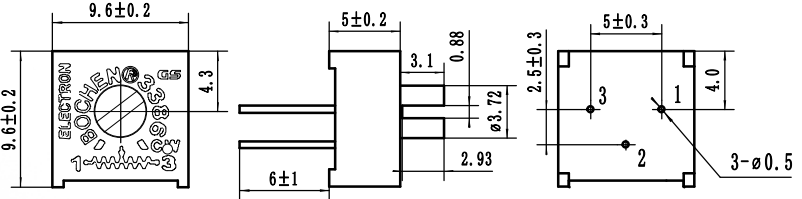
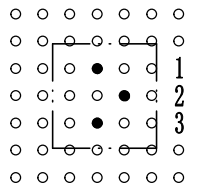
Product Dimensions

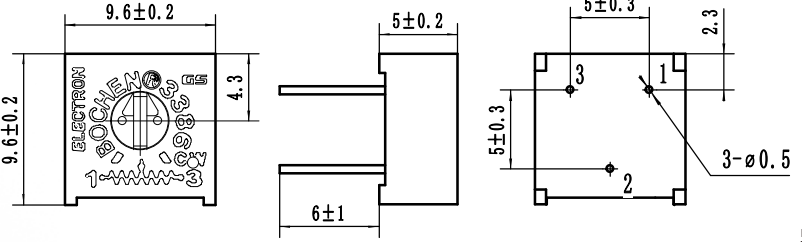
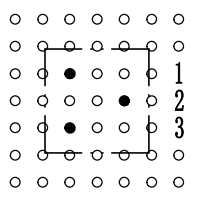
<p>Top Adjust</p>  <p>3386P</p>		<p>Terminal Spacing on a 2.54 PCB</p> 	<p>DIMENSIONS: MM TOLERANCES: ±0.3 MM EXCEPT WHERE NOTED</p>
<p>Top Adjust</p>  <p>3386P-EY8</p>		<p>Terminal Spacing on a 2.54 PCB</p> 	<p>DIMENSIONS: MM TOLERANCES: ±0.3 MM EXCEPT WHERE NOTED</p>
<p>Top Adjust</p>  <p>3386P-EY3</p>		<p>Terminal Spacing on a 2.54 PCB</p> 	<p>DIMENSIONS: MM TOLERANCES: ±0.3 MM EXCEPT WHERE NOTED</p>
<p>Top Adjust</p>  <p>3386F</p>		<p>Terminal Spacing on a 2.54 PCB</p> 	<p>DIMENSIONS: MM TOLERANCES: ±0.3 MM EXCEPT WHERE NOTED</p>
<p>Top Adjust</p>  <p>3386F-EY3</p>		<p>Terminal Spacing on a 2.54 PCB</p> 	<p>DIMENSIONS: MM TOLERANCES: ±0.3 MM EXCEPT WHERE NOTED</p>

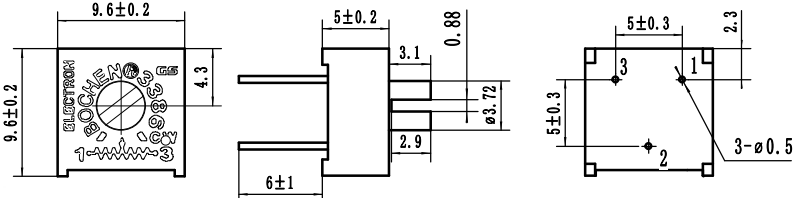
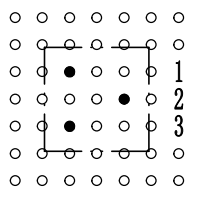
Product Dimensions

Top Adjust



3386U

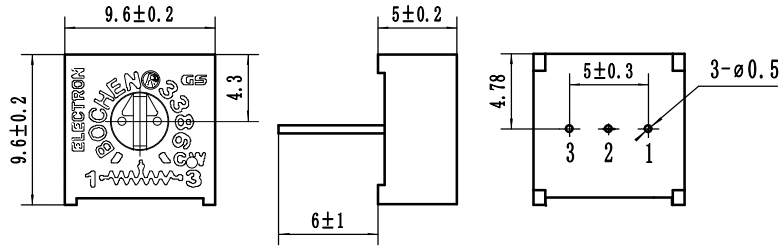

Terminal Spacing on a 2.54 PCB

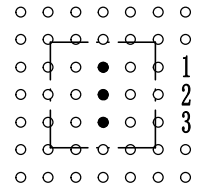

DIMENSIONS: MM
TOLERANCES: ±0.3 MM EXCEPT WHERE NOTED

Top Adjust



3386P-T

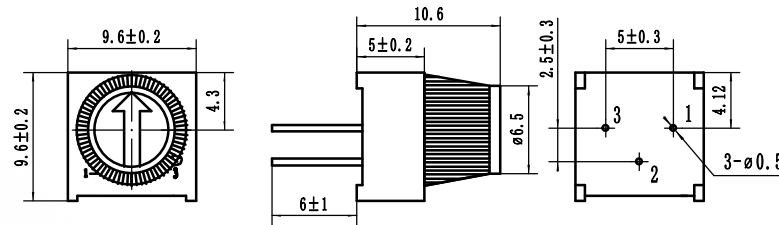

Terminal Spacing on a 2.54 PCB

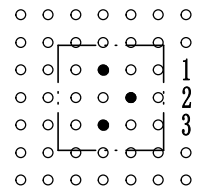

DIMENSIONS: MM
TOLERANCES: ±0.3 MM EXCEPT WHERE NOTED

Top Adjust



3386U-T

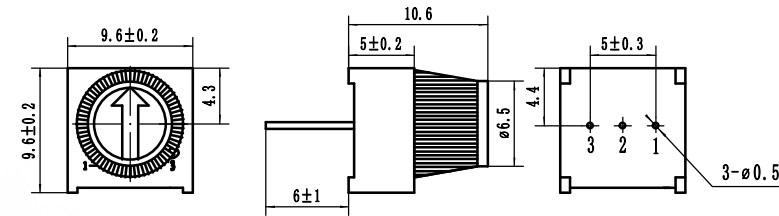

Terminal Spacing on a 2.54 PCB

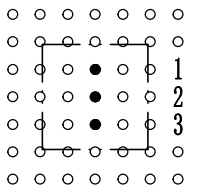

DIMENSIONS: MM
TOLERANCES: ±0.3 MM EXCEPT WHERE NOTED

Top Adjust



3386Y

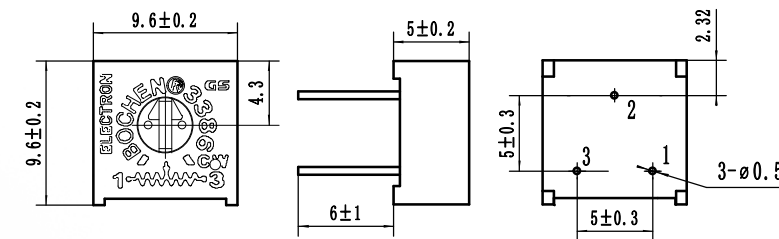

Terminal Spacing on a 2.54 PCB

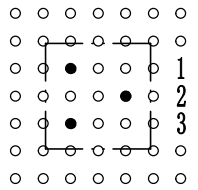

DIMENSIONS: MM
TOLERANCES: ±0.3 MM EXCEPT WHERE NOTED

Top Adjust



3386P-4

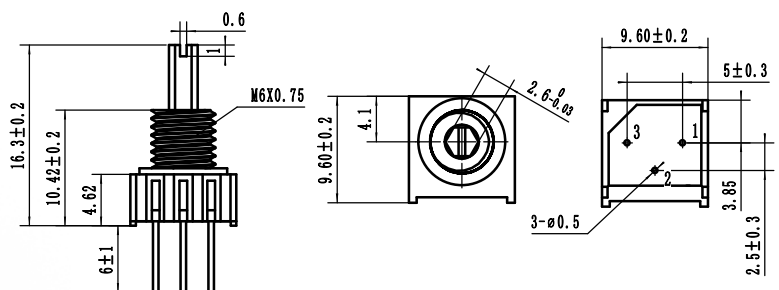

Terminal Spacing on a 2.54 PCB

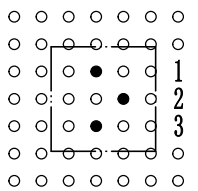

DIMENSIONS: MM
TOLERANCES: ±0.3 MM EXCEPT WHERE NOTED

Product Dimensions

Side Adjust



3386W

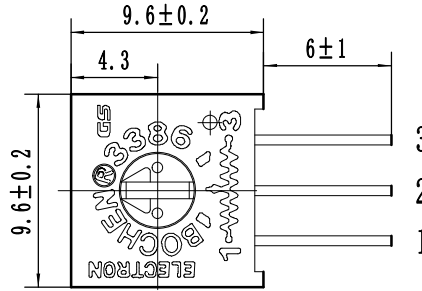
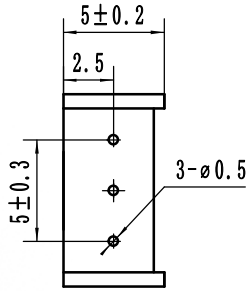

Terminal Spacing on a 2.54 PCB

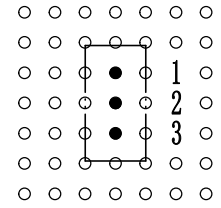

DIMENSIONS: MM
TOLERANCES: ±0.3 MM EXCEPT WHERE NOTED

Side Adjust



3386V

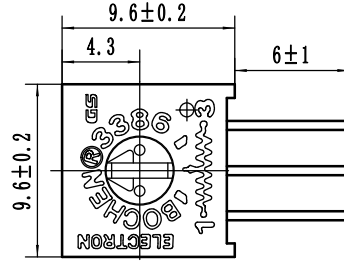
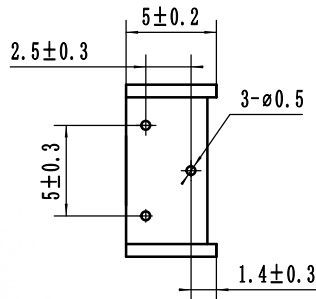

Terminal Spacing on a 2.54 PCB

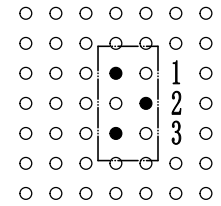

DIMENSIONS: MM
TOLERANCES: ±0.3 MM EXCEPT WHERE NOTED

Side Adjust



3386H

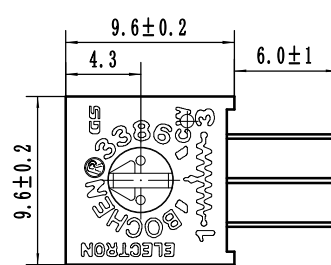
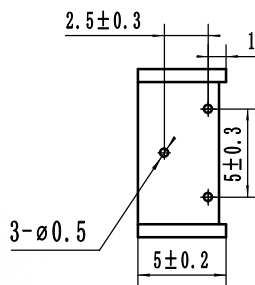

Terminal Spacing on a 2.54 PCB

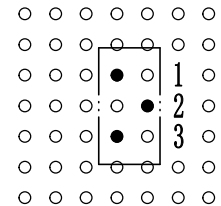

DIMENSIONS: MM
TOLERANCES: ±0.3 MM EXCEPT WHERE NOTED

Side Adjust



3386H-EY3

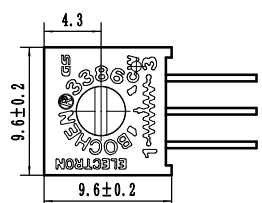
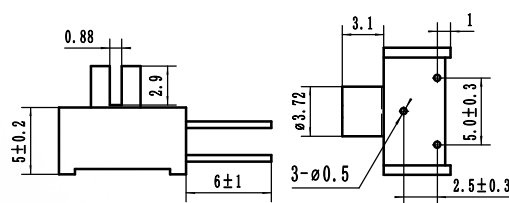

Terminal Spacing on a 2.54 PCB

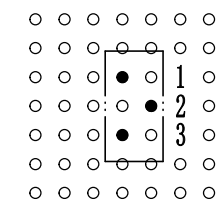

DIMENSIONS: MM
TOLERANCES: ±0.3 MM EXCEPT WHERE NOTED

Side Adjust

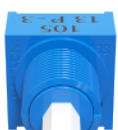

3386P-3

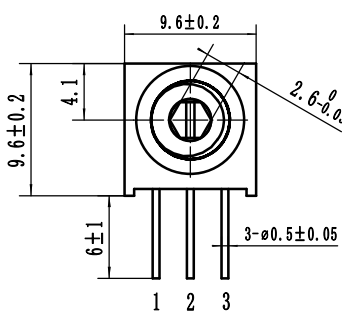
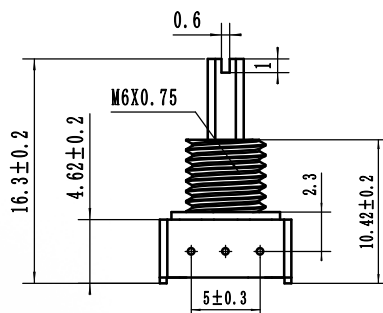

Terminal Spacing on a 2.54 PCB

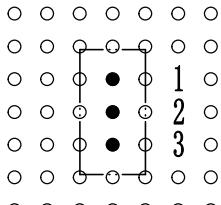

DIMENSIONS: MM
TOLERANCES: ±0.3 MM EXCEPT WHERE NOTED

Product Dimensions

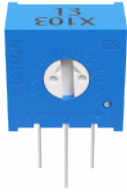

3386X

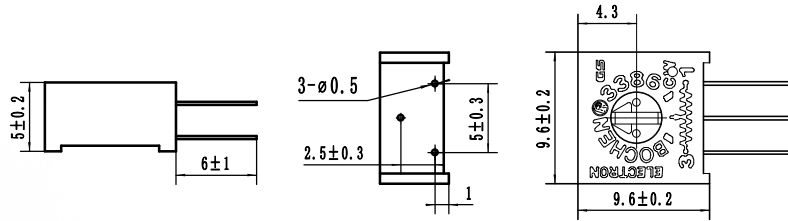

Terminal Spacing on a 2.54 PCB

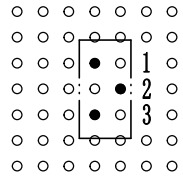

DIMENSIONS: MM
TOLERANCES: ±0.3 MM EXCEPT WHERE NOTED



3386X-EY3

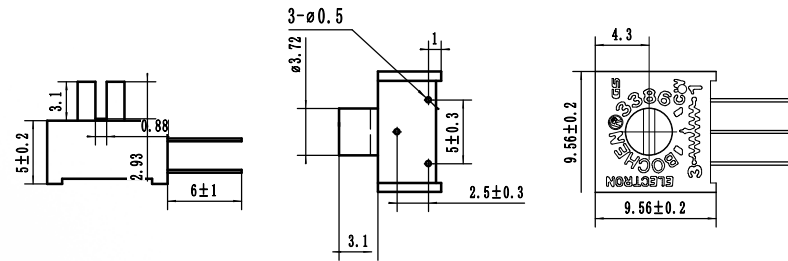

Terminal Spacing on a 2.54 PCB

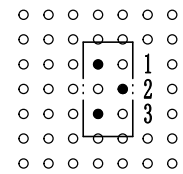

DIMENSIONS: MM
TOLERANCES: ±0.3 MM EXCEPT WHERE NOTED



3386T

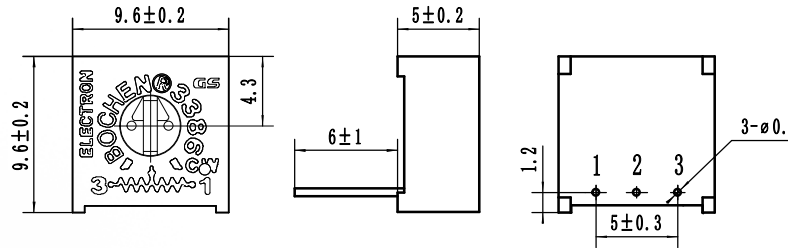

Terminal Spacing on a 2.54 PCB

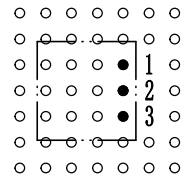

DIMENSIONS: MM
TOLERANCES: ±0.3 MM EXCEPT WHERE NOTED



3386C

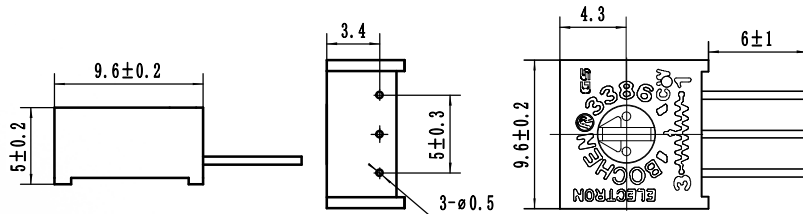

Terminal Spacing on a 2.54 PCB

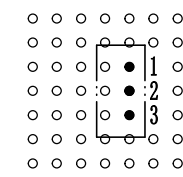

DIMENSIONS: MM
TOLERANCES: ±0.3 MM EXCEPT WHERE NOTED

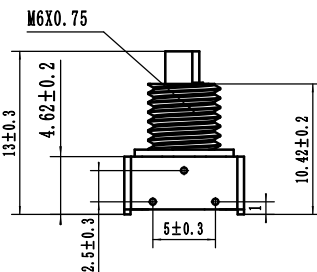

3386X-3

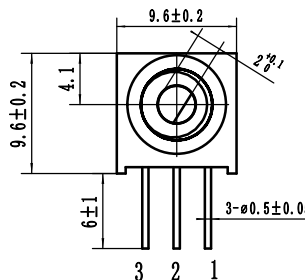

Terminal Spacing on a 2.54 PCB

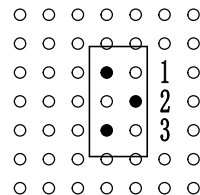

DIMENSIONS: MM
TOLERANCES: ±0.3 MM EXCEPT WHERE NOTED

Electrical Characteristics

Items	Parameters
Standard Resistance Range	10Ω-5MΩ
Resistance Tolerance	±10%
End Resistance	≤±1% R or 3Ω
Contact Resistance Variation	≤3%R or 3Ω
Insulation Resistance	500 Vdc. 100megohms min.
Withstanding Voltage	101.3KPa, 500 Vac; 8.5KPa, 250 Vac
Dielectric Strength Sea Level	500 Vac (1 minute)
Adjustment Angle	220°

Environmental Characteristics

Items	Parameters
Max. Soldering Exposure	250°C , 10 seconds
Power Rating(300 volts max.)	70°C, 0.5W; 125°C, 0W
Operating Temp. Range	-55°C ~ + 125°C
Temperature Coefficient	±250、±100 ppm /°C
Temperature Variation	ΔR≤±3%R, Δ(Uab/Uac) ≤±1%
Vibration	20G, ΔR≤±1%R, Δ(Uab/Uac) ≤±1%
Shock	100G, ΔR≤±1%R, Δ(Uab/Uac) ≤±2%
70°C Electrical Endurance	1000 hours @ 70°C Rated Power; ΔR≤±3%R
Rotational Life	200 cycles、ΔR≤±3%R

Physical Characteristics

Items	Parameters
Mechanical Angle	250°
Starting Torque	≤25 mN.m
Stop Strength	≤35 mN.m
Standard Packaging	50 pieces/tube

Standard Resistance Table

Resistance(Ohms)	Resistance Code
10	100
20	200
50	500
100	101
200	201
500	501
1,000	102
2,000	202
5,000	502
10,000	103
20,000	203
50,000	503
100,000	104
200,000	204
500,000	504
1,000,000	105
2,000,000	205

How to Order

