

Documentation | EN

EK9300

PROFINET-Bus Coupler for EtherCAT Terminals

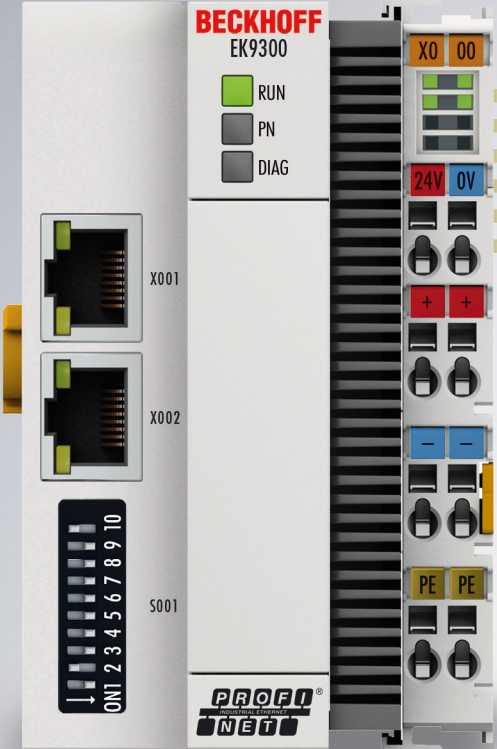

Table of contents

1 Foreword	5
1.1 Notes on the documentation	5
1.2 Guide through documentation	6
1.3 Safety instructions	7
1.4 Documentation issue status	8
1.5 Version identification of EtherCAT devices	9
1.5.1 General notes on marking.....	9
1.5.2 Version identification of EK Couplers.....	10
1.5.3 Beckhoff Identification Code (BIC).....	11
1.5.4 Electronic access to the BIC (eBIC).....	13
2 Product description	15
2.1 EKxxxx - System overview	15
2.2 PROFINET system presentation	16
2.3 EK9300 - Introduction	18
2.4 Technical data PROFINET.....	19
2.5 Technical data EK9300	20
3 Mounting and wiring	22
3.1 Mounting	22
3.1.1 Instructions for ESD protection	22
3.1.2 Explosion protection.....	23
3.1.3 UL notice	29
3.1.4 Dimensions	30
3.1.5 Installation on mounting rails – Bus Coupler.....	31
3.1.6 Disposal	33
3.2 Wiring	34
3.2.1 Note - Power supply.....	34
3.2.2 Power supply.....	35
3.2.3 Ethernet.....	36
4 Parameterization and commissioning	40
4.1 Meaning of the DIP switch	40
4.2 Further interfaces	41
4.3 Setting the IP address	42
5 Configuration	43
5.1 Representation of an EtherCAT slave on PROFINET	43
5.2 EK9300 configuration	48
5.3 EK9300 EtherCAT configuration	53
5.3.1 EK9300 Settings	56
5.4 EK9300 – Configuration example	58
5.4.1 Commissioning EL72x1-xxxx.....	59
5.4.2 EP9224 commissioning.....	70
5.4.3 EP9128 commissioning.....	74
5.5 From firmware Version 6.....	79
5.5.1 EK9300 - CoE data access over PROFINET.....	79

5.5.2	EK9300 - multi-configuration mode.....	81
5.5.3	EK9300 - IO-LINK	83
5.6	From firmware version 8	88
5.6.1	EBus Error Behaviour	88
5.6.2	Activating the web page.....	89
6	Error handling and diagnosis	91
6.1	Diagnostic LEDs.....	91
7	Appendix.....	93
7.1	FAQ.....	93
7.1.1	Device description file (GSDML) / DAP (DeviceAccessPoint)	94
7.1.2	Task configuration.....	96
7.1.3	EL663x-00x0 EtherCAT Terminals	97
7.1.4	BoxStates of the PROFINET devices	98
7.1.5	EK9300 – FAQ.....	99
7.2	Update Bus Coupler image	100
7.3	List of Abbreviations.....	101
7.4	Support and Service.....	103

1 Foreword

1.1 Notes on the documentation

Intended audience

This description is only intended for the use of trained specialists in control and automation engineering who are familiar with the applicable national standards.

It is essential that the documentation and the following notes and explanations are followed when installing and commissioning these components.

It is the duty of the technical personnel to use the documentation published at the respective time of each installation and commissioning.

The responsible staff must ensure that the application or use of the products described satisfy all the requirements for safety, including all the relevant laws, regulations, guidelines and standards.

Disclaimer

The documentation has been prepared with care. The products described are, however, constantly under development.

We reserve the right to revise and change the documentation at any time and without prior announcement.

No claims for the modification of products that have already been supplied may be made on the basis of the data, diagrams and descriptions in this documentation.

Trademarks

Beckhoff®, TwinCAT®, TwinCAT/BSD®, TC/BSD®, EtherCAT®, EtherCAT G®, EtherCAT G10®, EtherCAT P®, Safety over EtherCAT®, TwinSAFE®, XFC®, XTS® and XPlanar® are registered trademarks of and licensed by Beckhoff Automation GmbH. Other designations used in this publication may be trademarks whose use by third parties for their own purposes could violate the rights of the owners.

Patent Pending

The EtherCAT Technology is covered, including but not limited to the following patent applications and patents: EP1590927, EP1789857, EP1456722, EP2137893, DE102015105702 with corresponding applications or registrations in various other countries.



EtherCAT® is registered trademark and patented technology, licensed by Beckhoff Automation GmbH, Germany.

Copyright

© Beckhoff Automation GmbH & Co. KG, Germany.

The reproduction, distribution and utilization of this document as well as the communication of its contents to others without express authorization are prohibited.

Offenders will be held liable for the payment of damages. All rights reserved in the event of the grant of a patent, utility model or design.

1.2 Guide through documentation

NOTICE



Further components of documentation

This documentation describes device-specific content. It is part of the modular documentation concept for Beckhoff I/O components. For the use and safe operation of the device / devices described in this documentation, additional cross-product descriptions are required, which can be found in the following table.

Title	Description
EtherCAT System Documentation (PDF)	<ul style="list-style-type: none"> • System overview • EtherCAT basics • Cable redundancy • Hot Connect • EtherCAT devices configuration
Explosion Protection for Terminal Systems (PDF)	Notes on the use of the Beckhoff terminal systems in hazardous areas according to ATEX and IECEx
Control Drawing I/O, CX, CPX (PDF)	Connection diagrams and Ex markings (conform to cFMus)
Infrastructure for EtherCAT/Ethernet (PDF)	Technical recommendations and notes for design, implementation and testing
Software Declarations I/O (PDF)	Open source software declarations for Beckhoff I/O components

The documentations can be viewed at and downloaded from the Beckhoff website (www.beckhoff.com) via:

- the “Documentation and Download” area of the respective product page,
- the [Download finder](#),
- the [Beckhoff Information System](#).

1.3 Safety instructions

Safety regulations

Please note the following safety instructions and explanations!
Product-specific safety instructions can be found on following pages or in the areas mounting, wiring, commissioning etc.

Exclusion of liability

All the components are supplied in particular hardware and software configurations appropriate for the application. Modifications to hardware or software configurations other than those described in the documentation are not permitted, and nullify the liability of Beckhoff Automation GmbH & Co. KG.

Personnel qualification

This description is only intended for trained specialists in control, automation and drive engineering who are familiar with the applicable national standards.

Description of instructions

In this documentation the following instructions are used.
These instructions must be read carefully and followed without fail!

DANGER

Serious risk of injury!

Failure to follow this safety instruction directly endangers the life and health of persons.

WARNING

Risk of injury!

Failure to follow this safety instruction endangers the life and health of persons.

CAUTION

Personal injuries!

Failure to follow this safety instruction can lead to injuries to persons.

NOTICE

Damage to environment/equipment or data loss

Failure to follow this instruction can lead to environmental damage, equipment damage or data loss.

Tip or pointer

i This symbol indicates information that contributes to better understanding.

1.4 Documentation issue status

Version	Comment
3.3.5	<ul style="list-style-type: none"> • Update chapter "EK9300 – IO-Linkj" • Structural update
3.3.4	<ul style="list-style-type: none"> • Update chapter "Status and Ctrl. flag" • Structural update
3.3.3	<ul style="list-style-type: none"> • Update chapter "EK9300 IO-LINK" • Chapter "FAQ" added • Structural update
3.3.2	<ul style="list-style-type: none"> • Update chapter "Technical data" • Update chapter "EK9300 EtherCAT configuration" • Structural update
3.3.1	<ul style="list-style-type: none"> • Update chapter "Technical data" • Structural update
3.3.0	<ul style="list-style-type: none"> • Update chapter "Technical data"
3.2.6	<ul style="list-style-type: none"> • Update chapter "Configuration" • Structural update
3.2.5	<ul style="list-style-type: none"> • Update chapter "Configuration" • Structural update
3.2.4	<ul style="list-style-type: none"> • Update UL notes
3.2.3	<ul style="list-style-type: none"> • Update Technical data • Structural update
3.2.2	<ul style="list-style-type: none"> • Update chapter "Update Bus Coupler image"
3.2.1	<ul style="list-style-type: none"> • Technical data updated
3.2.0	<ul style="list-style-type: none"> • Configuration Added from firmware version 8 • Technical data updated
3.1.0	<ul style="list-style-type: none"> • Update chapter "Notes on the documentation" • Update chapter "EK9300 - PROFINET" -> "EKxxxx - System overview" • Update chapter "Technical data" • Note on ESD protection added • Chapter "ATEX - Special conditions (standard temperature range)" and note "ATEX documentation" added • Chapter "UL notes" inserted
3.0.0	<ul style="list-style-type: none"> • Migration • Structure update
2.1.0	<ul style="list-style-type: none"> • Chapter <i>COE data access over PROFINET</i> added • Chapter <i>Multi-configuration mode</i> added • Chapter <i>IO-LINK</i> added
2.0.0	<ul style="list-style-type: none"> • Addenda and corrections • First release
1.0.1	<ul style="list-style-type: none"> • Addenda and corrections
1.0.0	<ul style="list-style-type: none"> • Preliminary version

1.5 Version identification of EtherCAT devices

1.5.1 General notes on marking

Designation

A Beckhoff EtherCAT device has a 14-digit designation, made up of

- family key
- type
- version
- revision

Example	Family	Type	Version	Revision
EL3314-0000-0016	EL terminal 12 mm, non-pluggable connection level	3314 4-channel thermocouple terminal	0000 basic type	0016
ES3602-0010-0017	ES terminal 12 mm, pluggable connection level	3602 2-channel voltage measurement	0010 high-precision version	0017
CU2008-0000-0000	CU device	2008 8-port fast ethernet switch	0000 basic type	0000

Notes

- The elements mentioned above result in the **technical designation**. EL3314-0000-0016 is used in the example below.
- EL3314-0000 is the order identifier, in the case of “-0000” usually abbreviated to EL3314. “-0016” is the EtherCAT revision.
- The **order identifier** is made up of
 - family key (EL, EP, CU, ES, KL, CX, etc.)
 - type (3314)
 - version (-0000)
- The **revision** -0016 shows the technical progress, such as the extension of features with regard to the EtherCAT communication, and is managed by Beckhoff.
 In principle, a device with a higher revision can replace a device with a lower revision, unless specified otherwise, e.g. in the documentation.
 Associated and synonymous with each revision there is usually a description (ESI, EtherCAT Slave Information) in the form of an XML file, which is available for download from the Beckhoff web site.
 From 2014/01 the revision is shown on the outside of the IP20 terminals, see Fig. “EL5021 EL terminal, standard IP20 IO device with batch number and revision ID (since 2014/01)”.
- The type, version and revision are read as decimal numbers, even if they are technically saved in hexadecimal.

1.5.2 Version identification of EK Couplers

The serial number/ data code for Beckhoff IO devices is usually the 8-digit number printed on the device or on a sticker. The serial number indicates the configuration in delivery state and therefore refers to a whole production batch, without distinguishing the individual modules of a batch.

Structure of the serial number: **KK YY FF HH**

KK - week of production (CW, calendar week)

YY - year of production

FF - firmware version

HH - hardware version

Example with serial number 12 06 3A 02:

12 - production week 12

06 - production year 2006

3A - firmware version 3A

02 - hardware version 02



Fig. 1: EK1101 EtherCAT coupler with revision 0815 and serial number 41130206

1.5.3 Beckhoff Identification Code (BIC)

The Beckhoff Identification Code (BIC) is increasingly being applied to Beckhoff products to uniquely identify the product. The BIC is represented as a Data Matrix Code (DMC, code scheme ECC200), the content is based on the ANSI standard MH10.8.2-2016.

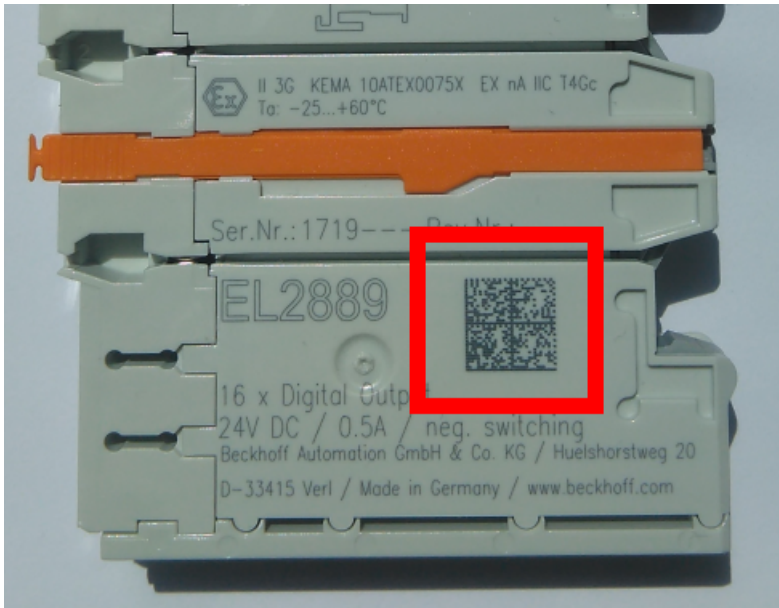

Fig. 2: BIC as data matrix code (DMC, code scheme ECC200)

The BIC will be introduced step by step across all product groups.

Depending on the product, it can be found in the following places:

- on the packaging unit
- directly on the product (if space suffices)
- on the packaging unit and the product

The BIC is machine-readable and contains information that can also be used by the customer for handling and product management.

Each piece of information can be uniquely identified using the so-called data identifier (ANSI MH10.8.2-2016). The data identifier is followed by a character string. Both together have a maximum length according to the table below. If the information is shorter, spaces are added to it.

Following information is possible, positions 1 to 4 are always present, the other according to need of production:

Position	Type of information	Explanation	Data identifier	Number of digits incl. data identifier	Example
1	Beckhoff order number	Beckhoff order number	1P	8	1P 072222
2	Beckhoff Traceability Number (BTN)	Unique serial number, see note below	SBTN	12	S BTNk4p562d7
3	Article description	Beckhoff article description, e.g. EL1008	1K	32	1K EL1809
4	Quantity	Quantity in packaging unit, e.g. 1, 10, etc.	Q	6	Q 1
5	Batch number	Optional: Year and week of production	2P	14	2P 401503180016
6	ID/serial number	Optional: Present-day serial number system, e.g. with safety products	51S	12	51S 678294
7	Variant number	Optional: Product variant number on the basis of standard products	30P	32	30P F971, 2*K183
...					

Further types of information and data identifiers are used by Beckhoff and serve internal processes.

Structure of the BIC

Example of composite information from positions 1 to 4 and with the above given example value on position 6. The data identifiers are highlighted in bold font:

1P072222**S**BTNk4p562d7**1K**EL1809 **Q**1 **51S**678294

Accordingly as DMC:



Fig. 3: Example DMC **1P**072222**S**BTNk4p562d7**1K**EL1809 **Q**1 **51S**678294

BTN

An important component of the BIC is the Beckhoff Traceability Number (BTN, position 2). The BTN is a unique serial number consisting of eight characters that will replace all other serial number systems at Beckhoff in the long term (e.g. batch designations on IO components, previous serial number range for safety products, etc.). The BTN will also be introduced step by step, so it may happen that the BTN is not yet coded in the BIC.

NOTICE

This information has been carefully prepared. However, the procedure described is constantly being further developed. We reserve the right to revise and change procedures and documentation at any time and without prior notice. No claims for changes can be made from the information, illustrations and descriptions in this information.

1.5.4 Electronic access to the BIC (eBIC)

Electronic BIC (eBIC)

The Beckhoff Identification Code (BIC) is applied to the outside of Beckhoff products in a visible place. If possible, it should also be electronically readable.

Decisive for the electronic readout is the interface via which the product can be electronically addressed.

K-bus devices (IP20, IP67)

Currently, no electronic storage and readout is planned for these devices.

EtherCAT devices (IP20, IP67)

All Beckhoff EtherCAT devices have a so-called ESI-EEPROM, which contains the EtherCAT identity with the revision number. Stored in it is the EtherCAT slave information, also colloquially known as ESI/XML configuration file for the EtherCAT master. See the corresponding chapter in the EtherCAT system manual ([Link](#)) for the relationships.

The eBIC is also stored in the ESI-EEPROM. The eBIC was introduced into the Beckhoff I/O production (terminals, box modules) from 2020; widespread implementation is expected in 2021.

The user can electronically access the eBIC (if existent) as follows:

- With all EtherCAT devices, the EtherCAT master (TwinCAT) can read the eBIC from the ESI-EEPROM
 - From TwinCAT 3.1 build 4024.11, the eBIC can be displayed in the online view.
 - To do this, check the checkbox "Show Beckhoff Identification Code (BIC)" under EtherCAT → Advanced Settings → Diagnostics:

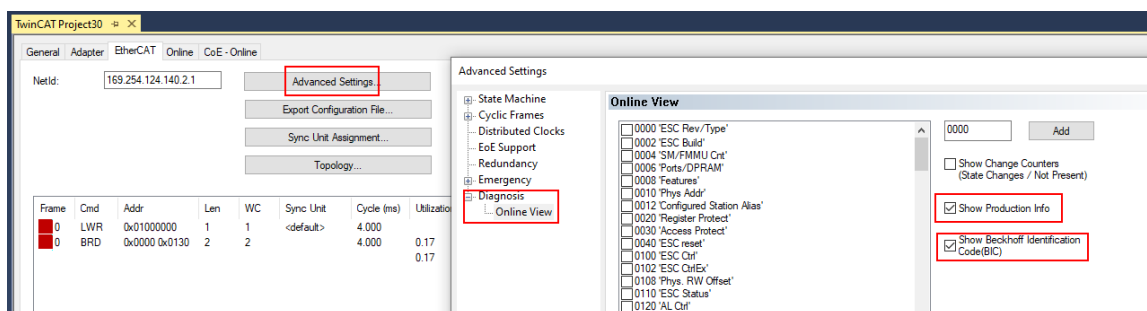

- The BTN and its contents are then displayed:

No	Addr	Name	State	CRC	Fw	Hw	Production Data	ItemNo	BTN	Description	Quantity	BatchNo	SerialNo
1	1001	Term 1 (EK1100)	OP	0,0	0	0	—	—	—	—	—	—	—
2	1002	Term 2 (EL1018)	OP	0,0	0	0	2020 KW36 Fr	072222	k4p562d7	EL1809	1	—	678294
3	1003	Term 3 (EL3204)	OP	0,0	7	6	2012 KW24 Sa	—	—	—	—	—	—
4	1004	Term 4 (EL2004)	OP	0,0	0	0	—	072223	k4p562d7	EL2004	1	—	678295
5	1005	Term 5 (EL1008)	OP	0,0	0	0	—	—	—	—	—	—	—
6	1006	Term 6 (EL2008)	OP	0,0	0	12	2014 KW14 Mo	—	—	—	—	—	—
7	1007	Term 7 (EK1110)	OP	0	1	8	2012 KW25 Mo	—	—	—	—	—	—

- Note: as can be seen in the illustration, the production data HW version, FW version and production date, which have been programmed since 2012, can also be displayed with "Show Production Info".
- From TwinCAT 3.1. build 4024.24 the functions *FB_EcReadBIC* and *FB_EcReadBTN* for reading into the PLC and further eBIC auxiliary functions are available in the Tc2_EtherCAT Library from v3.3.19.0.
- In the case of EtherCAT devices with CoE directory, the object 0x10E2:01 can additionally be used to display the device's own eBIC; the PLC can also simply access the information here:

- The device must be in PREOP/SAFEOP/OP for access:

Index	Name	Flags	Value
1000	Device type	RO	0x015E1389 (22942601)
1008	Device name	RO	ELM3704-0000
1009	Hardware version	RO	00
100A	Software version	RO	01
100B	Bootloader version	RO	J0.1.27.0
1011:0	Restore default parameters	RO	> 1 <
1018:0	Identity	RO	> 4 <
10E2:0	Manufacturer-specific Identification C...	RO	> 1 <
10E2:01	SubIndex 001	RO	1P158442SBTN0008jekp1KELM3704 Q1 2P482001000016
10F0:0	Backup parameter handling	RO	> 1 <
10F3:0	Diagnosis History	RO	> 21 <
10F8	Actual Time Stamp	RO	0x170fb277e

- the object 0x10E2 will be introduced into stock products in the course of a necessary firmware revision.
- From TwinCAT 3.1. build 4024.24 the functions *FB_EcCoEReadBIC* and *FB_EcCoEReadBTN* for reading into the PLC and further eBIC auxiliary functions are available in the *Tc2_EtherCAT Library* from v3.3.19.0.
- Note: in the case of electronic further processing, the BTN is to be handled as a string(8); the identifier "SBTN" is not part of the BTN.
- Technical background
The new BIC information is additionally written as a category in the ESI-EEPROM during the device production. The structure of the ESI content is largely dictated by the ETG specifications, therefore the additional vendor-specific content is stored with the help of a category according to ETG.2010. ID 03 indicates to all EtherCAT masters that they must not overwrite these data in case of an update or restore the data after an ESI update.
The structure follows the content of the BIC, see there. This results in a memory requirement of approx. 50..200 bytes in the EEPROM.
- Special cases
 - If multiple, hierarchically arranged ESCs are installed in a device, only the top-level ESC carries the eBIC Information.
 - If multiple, non-hierarchically arranged ESCs are installed in a device, all ESCs carry the eBIC Information.
 - If the device consists of several sub-devices with their own identity, but only the top-level device is accessible via EtherCAT, the eBIC of the top-level device is located in the CoE object directory 0x10E2:01 and the eBICs of the sub-devices follow in 0x10E2:nn.

PROFIBUS, PROFINET, DeviceNet devices etc.

Currently, no electronic storage and readout is planned for these devices.

2 Product description

2.1 EKxxxx - System overview



Fig. 4: EtherCAT Terminals at an EKxxxx series Bus Coupler

The Bus Couplers from the EKxxxx series allow EtherCAT Terminals to be operated on conventional fieldbus systems. The ultra-fast, high-performance EtherCAT Terminals with their large range of signal types are thus also available for other fieldbus and Industrial Ethernet systems.

The EKxxxx Bus Couplers are fieldbus slaves and contain an EtherCAT master for the EtherCAT terminals. They convert the telegrams from the higher-level fieldbus systems into the E-bus signal representation. A station consists of an EKxxxx and a number of EtherCAT Terminals.

The EKxxxx is integrated in exactly the same way as the Bus Couplers from the BKxxxx series via the corresponding fieldbus system configuration tools and the associated configuration files, such as GSD, ESD or GSDML.

EtherCAT makes a very flexible topology configuration possible. Thanks to the Ethernet physics, long distances can also be bridged without the bus speed being affected. When changing to the field level – without a control cabinet – the EtherCAT Box modules (EPxxxx) in protection class IP65 can also be connected to the EK9xxx.

Bus Couplers for various fieldbus systems

The variants from the EKxxxx series differ from one another by the interface for the higher-level fieldbus system.

An overview of the various Beckhoff Bus Couplers covering the most important fieldbus systems can be found on the [Beckhoff Website](#).

Embedded PCs with fieldbus interface and decentralized control

The TwinCAT-programmable variant is the CX80xx Embedded PC series.

The variants from the CX80xx series differ from one another by the interface for the higher-level fieldbus system and the possibility to program it.

An overview of the various Beckhoff Embedded PCs covering the most important fieldbus systems can be found on the [Beckhoff Website](#).

2.2 PROFINET system presentation

PROFINET is the Industrial Ethernet standard of the PNO (PROFIBUS user organization). PROFINET IO describes the data exchange between controllers and field devices in several real-time classes: RT (software-based Real-Time) and IRT (hardware-based Isochronous Real-Time). In addition, further Ethernet traffic can be transmitted in the NRT (non-real-time) time slot of the PROFINET cycle. RT can be networked with commercially available switches; switches with corresponding hardware support are required for IRT.

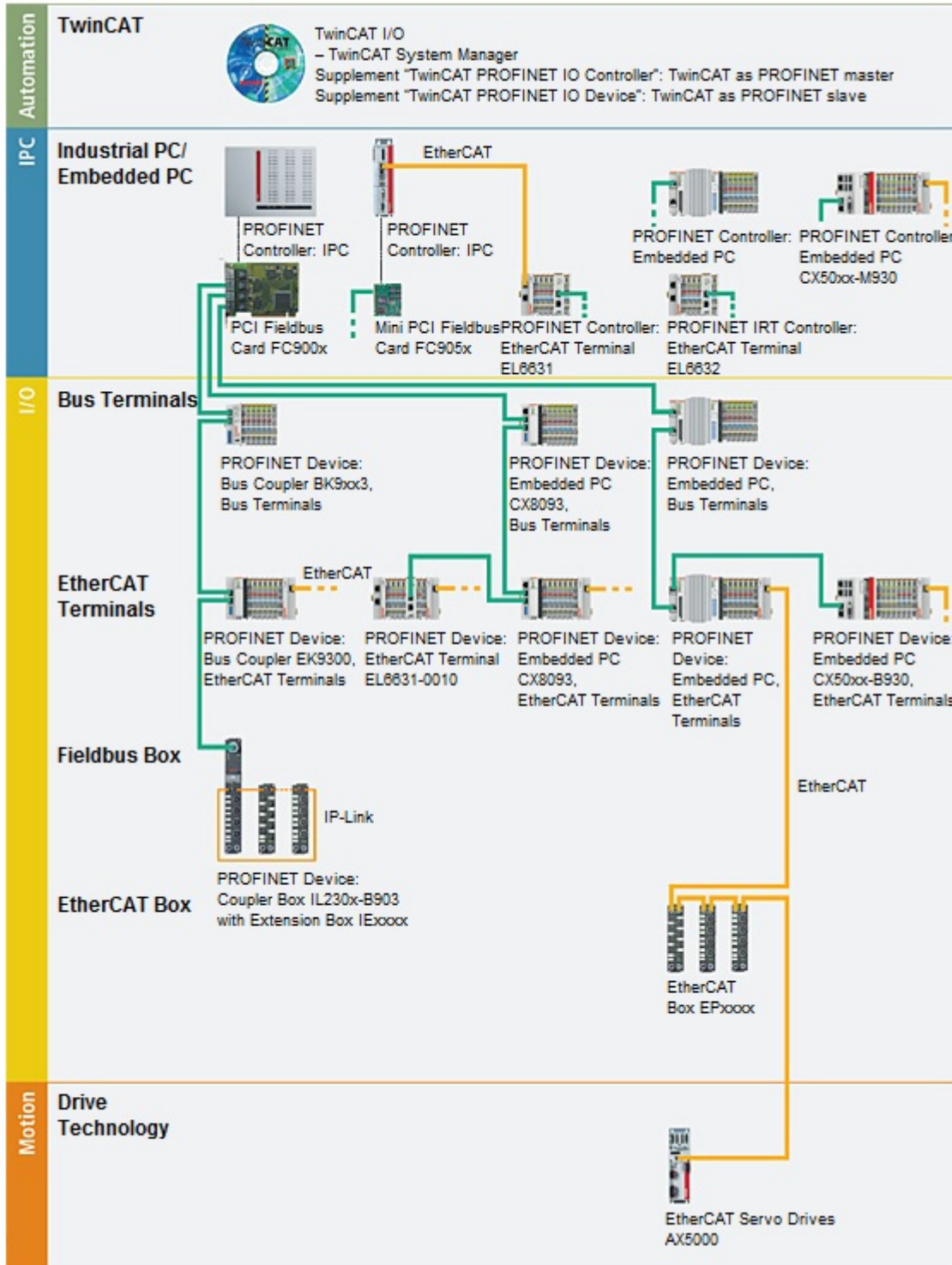

Components	Comment
Embedded PCs	
<u>CX8093</u>	Embedded PC with PROFINET RT Device fieldbus interface
<u>CX50xx-M930</u>	Embedded PC with optional PROFINET RT Controller interface
<u>CX50xx-B930</u>	Embedded PC with optional PROFINET RT Device interface
EtherCAT Terminals	
<u>EL6631</u>	PROFINET IO controller
<u>EL6631-0010</u>	PROFINET IO device
<u>EL6632</u>	PROFINET-IRT controller
Bus Coupler	
<u>BK9053</u>	PROFINET "Compact" Bus Coupler for Bus Terminals
<u>BK9103</u>	PROFINET Bus Coupler for Bus Terminals
<u>EK9300</u>	PROFINET Bus Coupler for EtherCAT Terminals
<u>EK9320</u>	PROFINET Bus Coupler for EtherCAT Terminals
EtherCAT Box	
<u>EP9300</u>	PROFINET Coupler Box for EtherCAT box modules
Fieldbus Box	
<u>IL230x-B903</u>	PROFINET Coupler Box for IP-Link box modules
PC Fieldbus cards	
<u>FC900x</u>	PCI-Ethernet card for all Ethernet (IEEE 802.3)-based protocols
<u>FC9x51</u>	Mini PCI-Ethernet card for all Ethernet (IEEE 802.3)-based protocols
TwinCAT	
<u>TwinCAT PROFINET IO Controller</u>	TwinCAT as PROFINET master
<u>TwinCAT PROFINET IO Device</u>	TwinCAT as PROFINET slave

2.3 EK9300 - Introduction

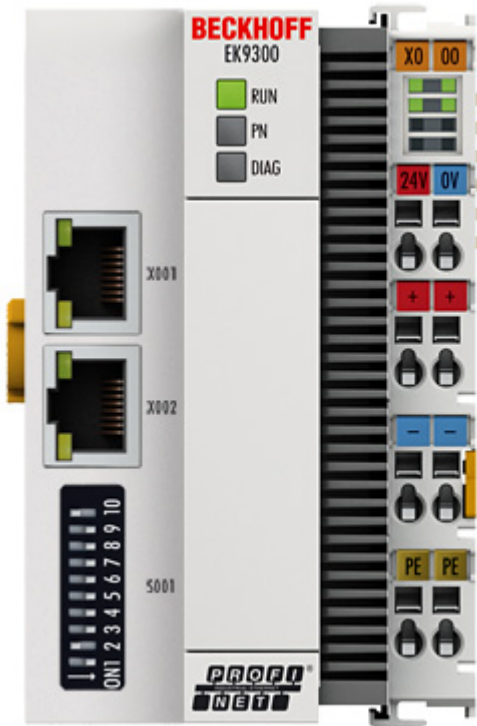

Fig. 5: EK9300

The EK9300 Bus Coupler connects PROFINET RT networks to the EtherCAT Terminals (ELxxxx) as well as the EtherCAT Box modules (EPxxxx) and converts the telegrams from PROFINET RT to the E-bus signal representation. One station consists of an EK9300 and any number of EtherCAT Terminals.

The coupler is connected to PROFINET RT via RJ45. In EtherCAT, the PROFINET RT coupler has at its disposal a lower-level, powerful and ultra-fast I/O system with a large selection of terminals. The coupler supports the PROFINET RT profile and fits seamlessly into PROFINET RT networks.

2.4 Technical data PROFINET

Technical data Ethernet	EK9300
Number of ports	2
integrated switch	2 x Ethernet 100 Mbit/s, 1 x USB device (behind the front flap)
Bus interface	2 x RJ 45 (switched)
100 Mbit/s	Yes, full-duplex PROFINET
Autocrossing	Yes
Protocol	
PROFINET IO DEVICE	Yes
ADS Interface	Yes
Services	
IRT	no
TCP/IP ADS	Yes
Shared Device	Yes
Prioritized startup	no
MRP	Yes
SNMP	Yes
LLDP	Yes
ARP	Yes
LLDP	Yes
DHCP	Yes
Diagnosis/Status/Alarm	
RUN LED	Yes, green/red
PN LED	Yes, green/red
DIAG LED	Yes, green/red
Connection display LINK TX/RX	Yes
Alarms	Yes
Diagnostic messages	Yes

2.5 Technical data EK9300

Technical data	EK9300
Protocol	PROFINET
Interfaces	2 x Ethernet 100 Mbit/s, 1 x USB device (behind the front flap)
Bus interface	2 x RJ 45 (switched)
I/O connection	E-bus (EtherCAT Terminals)
Web-based Management	from firmware 08 [▶ 88]
I/O terminals	E-bus (EL, ES, EP)
Power supply	24 V _{DC} (-15%/+20%)
Input current	120 mA typ. + (total E-bus current)/4
Power contacts	24 V _{DC} max./10 A max.
Power supply I/O terminals	2 A
Max. power loss	3 W
Max size of process data	max. 1440 bytes input and output data
Electrical isolation	500 V (power contact/supply voltage/Ethernet)
Dimensions (W x H x L)	64 mm x 100 mm x 73 mm
Operating/storage temperature	-25°C ... +60°C/-40°C...+85°C see note! **)
Installation position horizontal	
Operating/storage temperature other installation position	0...+55°C/-25...+85°C see note! **)
Relative humidity	95 % no condensation
Vibration/shock resistance	conforms to EN 60068-2-6/EN 60068-2-27
EMC immunity/emission	conforms to EN 61000-6-2/EN 61000-6-4
Protection rating/installation position	IP20/any
Markings / approvals *)	CE, EAC, UKCA cULus, ATEX [▶ 23], IECEx [▶ 25], cFMus [▶ 27]

*) Real applicable approvals/markings see type plate on the side (product marking).

i E-bus current/installation positions **)

- for -25 °C..+60 °C only horizontal installation position, E-bus current 1 A max.
- for 0...+55 °C, any installation position, E-bus current 2 A max.

System data	PROFINET (EK9300)
Number of I/O modules	control-dependent
Number of I/O points	control-dependent
Data transfer medium	4 x 2 twisted pair copper cables category 5 (100 Mbit/s)
Cable length	100 m
Data transfer rate	100 Mbit/s
Topology	star wiring, line topology

Ex markings

Standard	Marking
ATEX	II 3 G Ex nA IIC T4 Gc II 3 D Ex tc IIIC T135 °C Dc
IECEX	Ex nA IIC T4 Gc Ex tc IIIC T135 °C Dc
cFMus	Class I, Division 2, Groups A, B, C, D Class I, Zone 2, AEx/Ex ec IIC T4 Gc

3 Mounting and wiring

3.1 Mounting

3.1.1 Instructions for ESD protection

NOTICE

Destruction of the devices by electrostatic discharge possible!

The devices contain components at risk from electrostatic discharge caused by improper handling.

- Please ensure you are electrostatically discharged and avoid touching the contacts of the device directly.
- Avoid contact with highly insulating materials (synthetic fibers, plastic film etc.).
- Surroundings (working place, packaging and personnel) should be grounded probably, when handling with the devices.
- Each assembly must be terminated at the right hand end with an [EL9011](#) or [EL9012](#) bus end cap, to ensure the protection class and ESD protection.

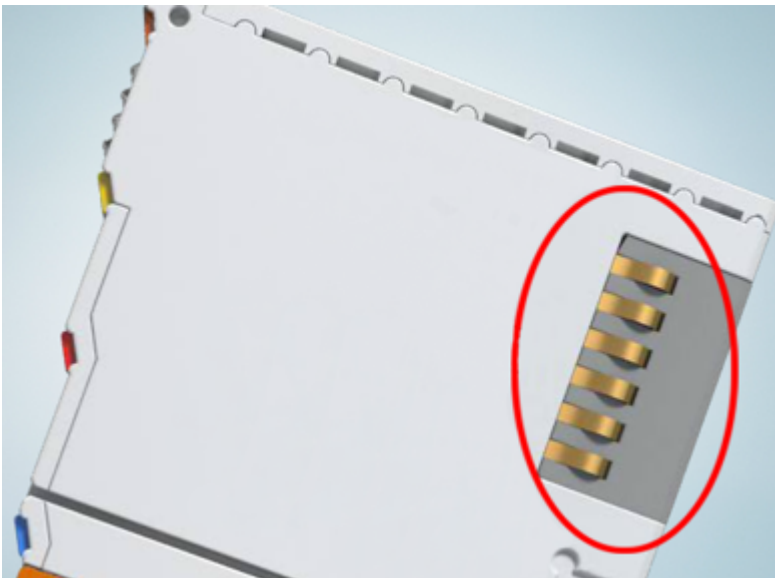

Fig. 6: Spring contacts of the Beckhoff I/O components

3.1.2 Explosion protection

3.1.2.1 ATEX - Special conditions (standard temperature range)

⚠ WARNING

Observe the special conditions for the intended use of Beckhoff fieldbus components with standard temperature range in potentially explosive areas (directive 2014/34/EU)!

- The certified components are to be installed in a suitable housing that guarantees a protection class of at least IP54 in accordance with EN 60079-15! The environmental conditions during use are thereby to be taken into account!
- For dust (only the fieldbus components of certificate no. KEMA 10ATEX0075 X Issue 9): The equipment shall be installed in a suitable enclosure providing a degree of protection of IP54 according to EN 60079-31 for group IIIA or IIIB and IP6X for group IIIC, taking into account the environmental conditions under which the equipment is used!
- If the temperatures during rated operation are higher than 70°C at the feed-in points of cables, lines or pipes, or higher than 80°C at the wire branching points, then cables must be selected whose temperature data correspond to the actual measured temperature values!
- Observe the permissible ambient temperature range of 0 to 55°C for the use of Beckhoff fieldbus components standard temperature range in potentially explosive areas!
- Measures must be taken to protect against the rated operating voltage being exceeded by more than 40% due to short-term interference voltages!
- The individual terminals may only be unplugged or removed from the Bus Terminal system if the supply voltage has been switched off or if a non-explosive atmosphere is ensured!
- The connections of the certified components may only be connected or disconnected if the supply voltage has been switched off or if a non-explosive atmosphere is ensured!
- The fuses of the KL92xx/EL92xx power feed terminals may only be exchanged if the supply voltage has been switched off or if a non-explosive atmosphere is ensured!
- Address selectors and ID switches may only be adjusted if the supply voltage has been switched off or if a non-explosive atmosphere is ensured!

Standards

The fundamental health and safety requirements are fulfilled by compliance with the following standards:

- EN 60079-0:2012+A11:2013
- EN 60079-15:2010
- EN 60079-31:2013 (only for certificate no. KEMA 10ATEX0075 X Issue 9)

Marking

The Beckhoff fieldbus components with standard temperature range certified according to the ATEX directive for potentially explosive areas bear one of the following markings:



II 3G KEMA 10ATEX0075 X Ex nA IIC T4 Gc Ta: 0 ... +55°C
II 3D KEMA 10ATEX0075 X Ex tc IIIC T135°C Dc Ta: 0 ... +55°C
 (only for fieldbus components of certificate no. KEMA 10ATEX0075 X Issue 9)

or



II 3G KEMA 10ATEX0075 X Ex nA nC IIC T4 Gc Ta: 0 ... +55°C
II 3D KEMA 10ATEX0075 X Ex tc IIIC T135°C Dc Ta: 0 ... +55°C
 (only for fieldbus components of certificate no. KEMA 10ATEX0075 X Issue 9)

3.1.2.2 ATEX - Special conditions (extended temperature range)

⚠ WARNING

Observe the special conditions for the intended use of Beckhoff fieldbus components with extended temperature range (ET) in potentially explosive areas (directive 2014/34/EU)!

- The certified components are to be installed in a suitable housing that guarantees a protection class of at least IP54 in accordance with EN 60079-15! The environmental conditions during use are thereby to be taken into account!
- For dust (only the fieldbus components of certificate no. KEMA 10ATEX0075 X Issue 9): The equipment shall be installed in a suitable enclosure providing a degree of protection of IP54 according to EN 60079-31 for group IIIA or IIIB and IP6X for group IIIC, taking into account the environmental conditions under which the equipment is used!
- If the temperatures during rated operation are higher than 70°C at the feed-in points of cables, lines or pipes, or higher than 80°C at the wire branching points, then cables must be selected whose temperature data correspond to the actual measured temperature values!
- Observe the permissible ambient temperature range of -25 to 60°C for the use of Beckhoff fieldbus components with extended temperature range (ET) in potentially explosive areas!
- Measures must be taken to protect against the rated operating voltage being exceeded by more than 40% due to short-term interference voltages!
- The individual terminals may only be unplugged or removed from the Bus Terminal system if the supply voltage has been switched off or if a non-explosive atmosphere is ensured!
- The connections of the certified components may only be connected or disconnected if the supply voltage has been switched off or if a non-explosive atmosphere is ensured!
- The fuses of the KL92xx/EL92xx power feed terminals may only be exchanged if the supply voltage has been switched off or if a non-explosive atmosphere is ensured!
- Address selectors and ID switches may only be adjusted if the supply voltage has been switched off or if a non-explosive atmosphere is ensured!

Standards

The fundamental health and safety requirements are fulfilled by compliance with the following standards:

- EN 60079-0:2012+A11:2013
- EN 60079-15:2010
- EN 60079-31:2013 (only for certificate no. KEMA 10ATEX0075 X Issue 9)

Marking

The Beckhoff fieldbus components with extended temperature range (ET) certified according to the ATEX directive for potentially explosive areas bear the following marking:



II 3G KEMA 10ATEX0075 X Ex nA IIC T4 Gc Ta: -25 ... +60°C
 II 3D KEMA 10ATEX0075 X Ex tc IIIC T135°C Dc Ta: -25 ... +60°C
 (only for fieldbus components of certificate no. KEMA 10ATEX0075 X Issue 9)

or



II 3G KEMA 10ATEX0075 X Ex nA nC IIC T4 Gc Ta: -25 ... +60°C
 II 3D KEMA 10ATEX0075 X Ex tc IIIC T135°C Dc Ta: -25 ... +60°C
 (only for fieldbus components of certificate no. KEMA 10ATEX0075 X Issue 9)

3.1.2.3 IECEx - Special conditions

⚠ WARNING

Observe the special conditions for the intended use of Beckhoff fieldbus components in potentially explosive areas!

- For gas: The equipment shall be installed in a suitable enclosure providing a degree of protection of IP54 according to IEC 60079-15, taking into account the environmental conditions under which the equipment is used!
- For dust (only the fieldbus components of certificate no. IECEx DEK 16.0078X Issue 3):
The equipment shall be installed in a suitable enclosure providing a degree of protection of IP54 according to EN 60079-31 for group IIIA or IIIB and IP6X for group IIIC, taking into account the environmental conditions under which the equipment is used!
- The equipment shall only be used in an area of at least pollution degree 2, as defined in IEC 60664-1!
- Provisions shall be made to prevent the rated voltage from being exceeded by transient disturbances of more than 119 V!
- If the temperatures during rated operation are higher than 70°C at the feed-in points of cables, lines or pipes, or higher than 80°C at the wire branching points, then cables must be selected whose temperature data correspond to the actual measured temperature values!
- Observe the permissible ambient temperature range for the use of Beckhoff fieldbus components in potentially explosive areas!
- The individual terminals may only be unplugged or removed from the Bus Terminal system if the supply voltage has been switched off or if a non-explosive atmosphere is ensured!
- The connections of the certified components may only be connected or disconnected if the supply voltage has been switched off or if a non-explosive atmosphere is ensured!
- Address selectors and ID switches may only be adjusted if the supply voltage has been switched off or if a non-explosive atmosphere is ensured!
- The front hatch of certified units may only be opened if the supply voltage has been switched off or a non-explosive atmosphere is ensured!

Standards

The fundamental health and safety requirements are fulfilled by compliance with the following standards:

- EN 60079-0:2011
- EN 60079-15:2010
- EN 60079-31:2013 (only for certificate no. IECEx DEK 16.0078X Issue 3)

Marking

Beckhoff fieldbus components that are certified in accordance with IECEx for use in areas subject to an explosion hazard bear the following markings:

Marking for fieldbus components of certificate no. IECEx DEK 16.0078X Issue 3:	IECEx DEK 16.0078 X Ex nA IIC T4 Gc Ex tc IIIC T135°C Dc
--	---

Marking for fieldbus components of certificates with later issues:	IECEx DEK 16.0078 X Ex nA IIC T4 Gc
--	--

3.1.2.4 Continulative documentation for ATEX and IECEx

NOTICE



Continulative documentation about explosion protection according to ATEX and IECEx

Pay also attention to the continuative documentation

Ex. Protection for Terminal Systems

Notes on the use of the Beckhoff terminal systems in hazardous areas according to ATEX and IECEx,

that is available for [download](#) within the download area of your product on the Beckhoff homepage www.beckhoff.com!

3.1.2.5 cFMus - Special conditions

WARNING

Observe the special conditions for the intended use of Beckhoff fieldbus components in potentially explosive areas!

- The equipment shall be installed within an enclosure that provides a minimum ingress protection of IP54 in accordance with ANSI/UL 60079-0 (US) or CSA C22.2 No. 60079-0 (Canada).
- The equipment shall only be used in an area of at least pollution degree 2, as defined in IEC 60664-1.
- Transient protection shall be provided that is set at a level not exceeding 140% of the peak rated voltage value at the supply terminals to the equipment.
- The circuits shall be limited to overvoltage Category II as defined in IEC 60664-1.
- The Fieldbus Components may only be removed or inserted when the system supply and the field supply are switched off, or when the location is known to be non-hazardous.
- The Fieldbus Components may only be disconnected or connected when the system supply is switched off, or when the location is known to be non-hazardous.

Standards

The fundamental health and safety requirements are fulfilled by compliance with the following standards:

M20US0111X (US):

- FM Class 3600:2018
- FM Class 3611:2018
- FM Class 3810:2018
- ANSI/UL 121201:2019
- ANSI/ISA 61010-1:2012
- ANSI/UL 60079-0:2020
- ANSI/UL 60079-7:2017

FM20CA0053X (Canada):

- CAN/CSA C22.2 No. 213-17:2017
- CSA C22.2 No. 60079-0:2019
- CAN/CSA C22.2 No. 60079-7:2016
- CAN/CSA C22.2 No.61010-1:2012

Marking

Beckhoff fieldbus components that are certified in accordance with cFMus for use in areas subject to an explosion hazard bear the following markings:

FM20US0111X (US): **Class I, Division 2, Groups A, B, C, D**
 Class I, Zone 2, AEx ec IIC T4 Gc

FM20CA0053X (Canada): **Class I, Division 2, Groups A, B, C, D**
 Ex ec T4 Gc

3.1.2.6 Continuitive documentation for cFMus

NOTICE



Continuitive documentation about explosion protection according to cFMus



Pay also attention to the continuative documentation

Control Drawing I/O, CX, CPX

Connection diagrams and Ex markings,

that is available for download within the download area of your product on the Beckhoff homepage www.beckhoff.com!

3.1.3 UL notice

⚠ CAUTION	
	<p>Application Beckhoff EtherCAT modules are intended for use with Beckhoff's UL Listed EtherCAT System only.</p>
⚠ CAUTION	
	<p>Examination For cULus examination, the Beckhoff I/O System has only been investigated for risk of fire and electrical shock (in accordance with UL508 and CSA C22.2 No. 142).</p>
⚠ CAUTION	
	<p>For devices with Ethernet connectors Not for connection to telecommunication circuits.</p>

Basic principles

UL certification according to UL508 with limited power consumption. The current consumed by the device is limited to a max. possible current consumption of 4 A. Devices with this kind of certification are marked by this sign:

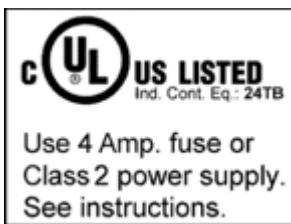

Application

If terminals certified *with restrictions* are used, then the current consumption at 24 V_{DC} must be limited accordingly by means of supply

- from an isolated source protected by a fuse of max. 4 A (according to UL248) or
- from a voltage supply complying with *NEC class 2*.
A voltage source complying with *NEC class 2* may not be connected in series or parallel with another *NEC class 2*compliant voltage supply!

These requirements apply to the supply of all EtherCAT bus couplers, power adaptor terminals, Bus Terminals and their power contacts.

3.1.4 Dimensions

The following illustrations show the dimensions of the Bus Couplers.

Drawings in [DWF](#) and [STEP](#) format can be found in the Download section of the Beckhoff website.

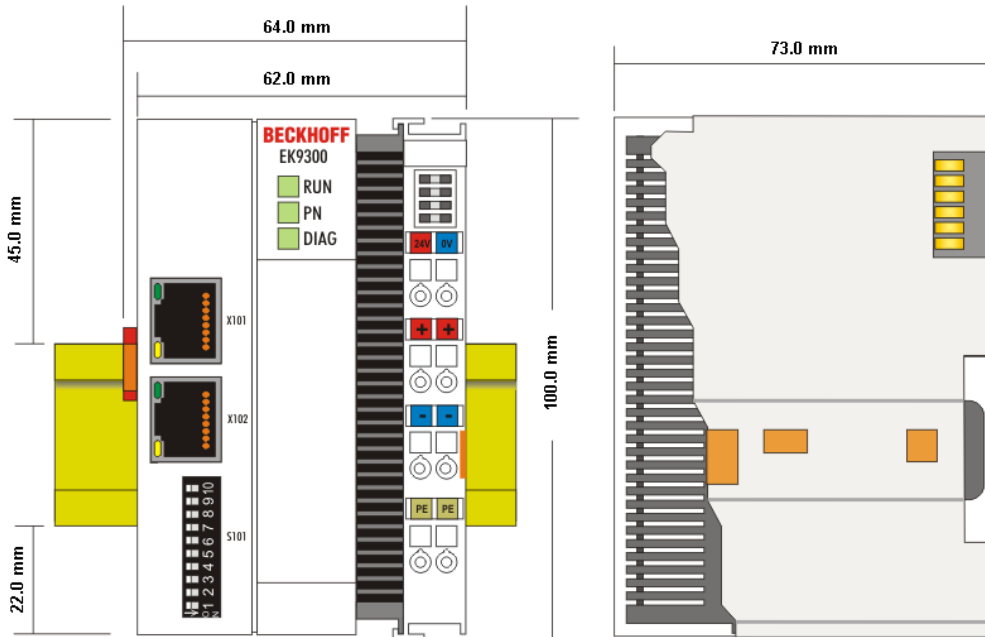

Fig. 7: EK9xxx – dimensions taking the EK9300 as an example

3.1.5 Installation on mounting rails – Bus Coupler

Snapping onto the mounting rail

The Bus Coupler can simply be snapped onto the mounting rail. To this end position the block on the mounting rail and push it slightly until it engages on the right-hand side. This is indicated by a distinct click. Use a screwdriver to push up the lock on the left-hand side, thereby turning it and causing it to engage audibly.

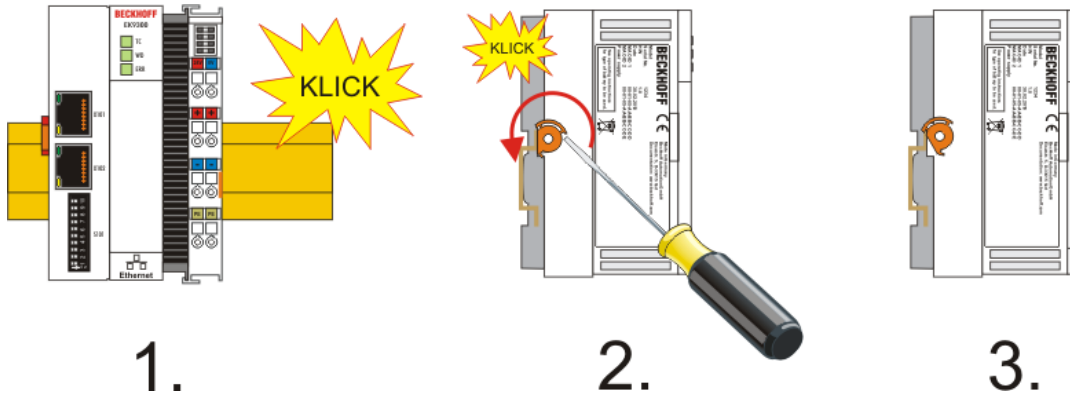

Fig. 8: EK9300 - Snapping onto the mounting rail

NOTICE

Avoid damage!
Do not force the module or apply excessive pressure!

Installation positions

The installation position of the Bus Coupler is arbitrary.

NOTICE

Installation position of EtherCAT terminals
Observe the installation position of the EtherCAT terminals used – not all of them have an arbitrary installation position. Pay attention to the respective EtherCAT infrastructure components and installation instructions.

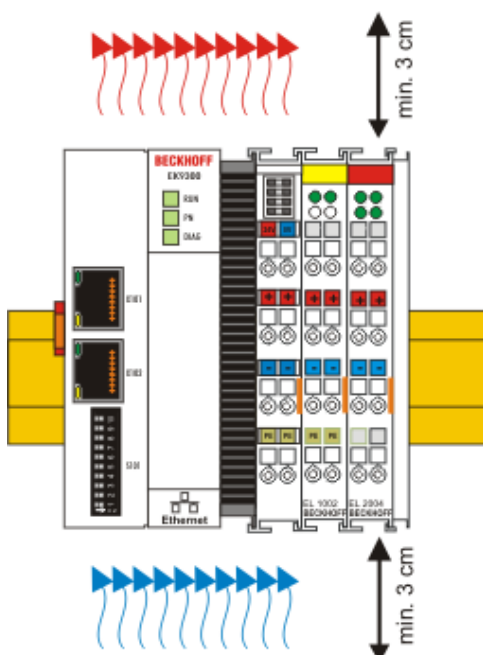

Fig. 9: Recommended distances for standard installation position

NOTICE

Comply with the permitted installation position and minimum distances!

We recommend the installation in the horizontal position for optimum ventilation. Furthermore, it is not necessary with this installation position to check whether there are terminals present that may only be installed horizontally.

Other installation positions are allowed, but not recommended.

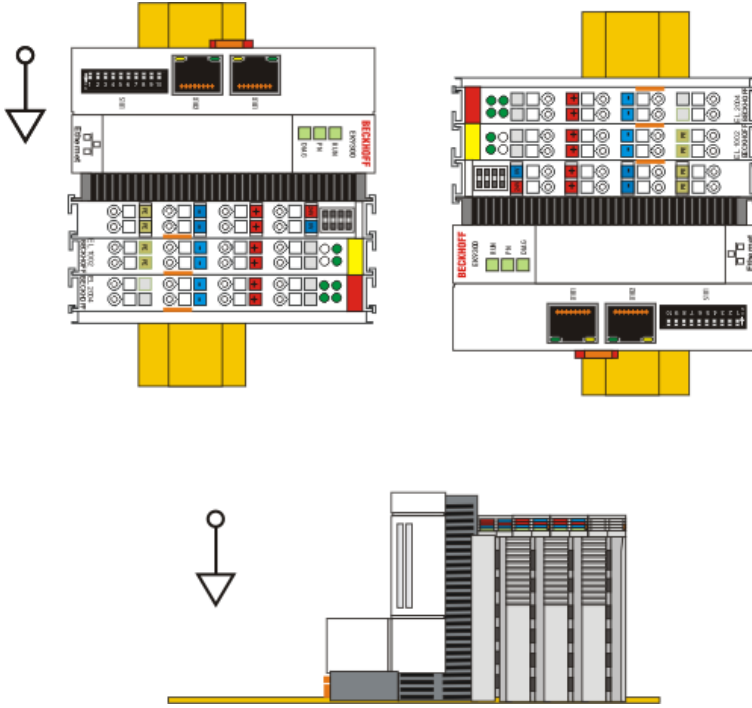

Fig. 10: Other installation positions

3.1.6 Disposal



Products marked with a crossed-out wheeled bin shall not be discarded with the normal waste stream. The device is considered as waste electrical and electronic equipment. The national regulations for the disposal of waste electrical and electronic equipment must be observed.

3.2 Wiring

3.2.1 Note - Power supply

⚠ WARNING

Power supply from SELV/PELV power supply unit!

SELV/PELV circuits (Safety Extra Low Voltage, Protective Extra Low Voltage) according to IEC 61010-2-201 must be used to supply this device.

Notes:

- SELV/PELV circuits may give rise to further requirements from standards such as IEC 60204-1 et al, for example with regard to cable spacing and insulation.
- A SELV (Safety Extra Low Voltage) supply provides safe electrical isolation and limitation of the voltage without a connection to the protective conductor, a PELV (Protective Extra Low Voltage) supply also requires a safe connection to the protective conductor.

3.2.2 Power supply

The power supply unit is equipped with an I/O interface, which permits connection of the Beckhoff Bus Terminals. The power is supplied via the upper spring-loaded terminals with the designations "24 V" and "0 V".

The supply voltage supplies the EK system and, via the terminal bus, the Bus Terminals with a voltage of 24 V_{DC} (-15%/+20 %). The dielectric strength of the power supply is 500 V. Since the terminal bus (E-bus) only transfers data, a separate power supply is required for the Bus Terminals. This is provided by means of the power contacts, which are not connected to the power supply.

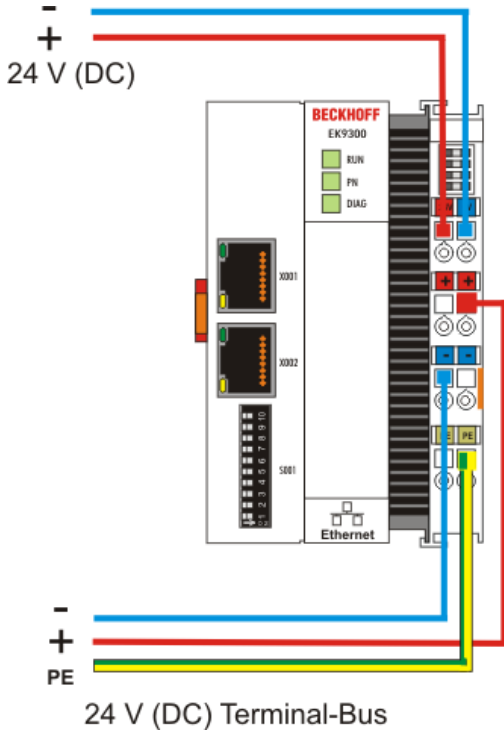

Fig. 11: Bus Coupler EK9xxx power supply

Requirements for the 24 V power supply

In order to guarantee the operation of the Bus Coupler and the terminal segment in all cases, the power supply unit must supply 2.0 A at 24 V.

LED

If the power supply unit is connected correctly and the power supply is switched on, the two upper LEDs in the terminal prism are green. The left LED (Us) indicates the CPU supply. The right LED (Up) indicates the terminal supply. The other LEDs indicate the Terminal Bus status. A detailed description of the LEDs can be found in section "LED troubleshooting".

PE power contacts

NOTICE

Power contact "PE"

The "PE" power contact must not be used for other potentials.

3.2.3 Ethernet

3.2.3.1 Ethernet connections



Fig. 12: RJ45 interface

Assignment of the RJ45 interface, port (switched)

EK9xxx: X001 / X002

PIN	Signal	Description
1	TD +	Transmit +
2	TD -	Transmit -
3	RD +	Receive +
4	connected	reserved
5		
6	RD -	Receive -
7	connected	reserved
8		

3.2.3.2 Ethernet cable

Transmission standards

10Base5

The transmission medium for 10Base5 consists of a thick coaxial cable ("yellow cable") with a max. transmission speed of 10 Mbit/s arranged in a line topology with branches (drops) each of which is connected to one network device. Because all the devices are in this case connected to a common transmission medium, it is inevitable that collisions occur often in 10Base5.

10Base2

10Base2 (Cheaper net) is a further development of 10Base5, and has the advantage that the coaxial cable is cheaper and, being more flexible, is easier to lay. It is possible for several devices to be connected to one 10Base2 cable. It is frequent for branches from a 10Base5 backbone to be implemented in 10Base2.

10BaseT

Describes a twisted pair cable for 10 Mbit/s. The network here is constructed as a star. It is no longer the case that every device is attached to the same medium. This means that a broken cable no longer results in failure of the entire network. The use of switches as star couplers enables collisions to be reduced. Using full-duplex connections they can even be entirely avoided.

100BaseT

Twisted pair cable for 100 Mbit/s. It is necessary to use a higher cable quality and to employ appropriate hubs or switches in order to achieve the higher data rate.

10BaseF

The 10BaseF standard describes several optical fiber versions.

Short description of the 10BaseT and 100BaseT cable types

Twisted-pair copper cable for star topologies, where the distance between two devices may not exceed 100 meters.

UTP

Unshielded twisted pair

This type of cable belongs to category 3, and is not recommended for use in an industrial environment.

S/UTP

Screened/unshielded twisted pair (screened with copper braid)

Has an overall shield of copper braid to reduce influence of external interference. This cable is recommended for use with Bus Couplers.

FTP

Foiled shielded twisted pair (screened with aluminum foil)

This cable has an overall shield of laminated aluminum and plastic foil.

S/FTP

Screened/foiled-shielded twisted pair (screened with copper braid and aluminum foil)

Has a laminated aluminum screen with a copper braid on top. Such cables can provide up to 70 dB reduction in interference power.

STP

Shielded twisted pair

Describes a cable with an outer screen, without defining the nature of the screen any more closely.

S/STP

Screened/shielded twisted pair (wires are individually screened)

This identification refers to a cable with a shield for each of the two wires as well as an overall shield.

ITP

Industrial Twisted-Pair

The structure is similar to that of S/STP, but, in contrast to S/STP, it has only one pair of conductors.

3.2.3.3 EK9300 PROFINET topology sample

EK9300

The construction of the EK9300 can take place in a line, with adherence to the following points:

- Maximum 20 couplers one behind the other
- No switches should be used in the line

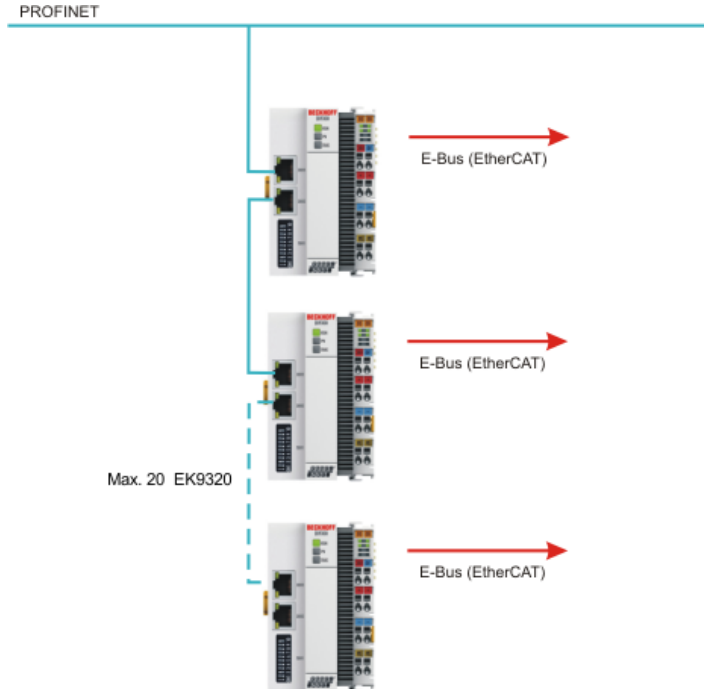

Fig. 13: EK9300 - Topology sample

i Use of switches without LLDP

PROFINET uses the LLDP protocol for the topology recognition. The topology recognition and the associated PROFINET services will not work properly if the switch that you use does not support this. In addition, this results in increased network traffic, which is multiplied further with each switch port and connected PROFINET device. The effects of this can be communication errors extending up to the aborting of communication with individual PROFINET devices.

4 Parameterization and commissioning

4.1 Meaning of the DIP switch

10-pole DIP switch S001

The DIP switch has the following meaning for the Ethernet interfaces X001 and X002, which are switched:



Fig. 14: DIP switch S001: Left off "0", right on "1"

DIP 9	DIP 10	Description DIP 1..8	Restart behavior	Behavior with factory settings
0	0	Last byte of the IP address via DIP switches 1 to 8	<ul style="list-style-type: none"> PN name from memory IP address via DIP switches 172.16.17.xxx (xxx DIP switch) SNM 255.255.0.0 	<ul style="list-style-type: none"> PN name becomes empty string IP address via DIP switches 172.16.17.xxx (xxx DIP switch) SNM 255.255.0.0
0	1	DHCP DIP switch 1 to 8 set to OFF	<ul style="list-style-type: none"> PN name from memory IP address and SNM via DHCP 	<ul style="list-style-type: none"> PN name becomes empty string IP address and SNM via DHCP
		DHCP DIP switch 1 to 8 set to ON	<ul style="list-style-type: none"> PN name from memory IP address from memory 	<ul style="list-style-type: none"> PN name becomes empty string IP address 0.0.0.0
1	0	Reserved		
1	1	PROFINET-compliant DIP switch 1 to 8 set to OFF	<ul style="list-style-type: none"> PN name from memory IP address from memory 	<ul style="list-style-type: none"> PN name becomes empty string IP address 0.0.0.0
		PROFINET with fixed name DIP switch 1 to 8 set to ON	<ul style="list-style-type: none"> PN name via DIP switch 1 to 8 IP address from memory 	<ul style="list-style-type: none"> PN name via DIP switch 1 to 8 IP address 0.0.0.0

2-pole DIP switch (under the flap between the battery and the SD card slot)

DIP switch (red)	Meaning
1 off and 2 off	normal mode, coupler is started
1 on and 2 off	The EK starts in Config Mode; the internal Flash memory can be accessed via the USB interface (for example for an image update).
1 off and 2 on	Manufacturer's setting
1 on and 2 on	No function so far

4.2 Further interfaces

Additional interfaces are located under the flap of the EK9xx0.

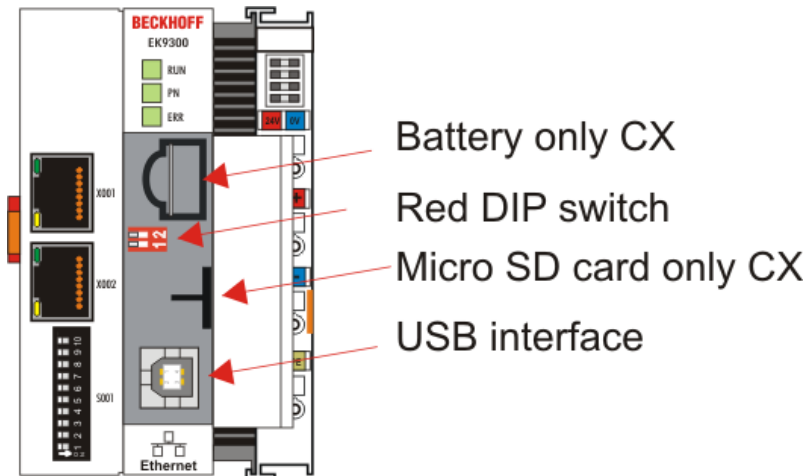

Fig. 15: Additional interfaces of the EK9xx0

Battery

No battery is required for the EK9xx0, therefore this option is not included.

Red DIP switch

Default setting is OFF/OFF.

In order, for example, to load new firmware to the EK via USB, the first DIP switch must be set to “1” before switching on. If the RUN LED lights up blue, the EK can be connected to the PC by a USB cable. The PC then finds the internal Flash as the storage medium. The storage medium may not be formatted!

Micro SD card

Alternatively the firmware can also be loaded to an SD card. Booting always takes place from the SD card if there is one in the slot. This can be used, for example, to test a firmware before copying it to the EK’s internal Flash.

USB interface

The USB interface can only be used if the “red” DIP switch has been set accordingly. See “Red DIP switch”.

4.3 Setting the IP address

Usually the IP address is assigned by the PROFINET controller. By default the EK9300 has no IP address. An IP address is necessary, however, in order to reach the device by ADS. This can be assigned by DHCP (a DHCP server must be present) or a fixed IP address can be used. See chapter [DIP switch \[► 40\]](#).

If the PROFINET controller is connected, the IP address assigned by the controller is used for PROFINET communication. The fixed IP address or the one assigned by the DHCP is overwritten.

A further possibility is to communicate with the EK9300 via the IP address assigned by the controller; to do this, however, the device must have been initialized at least once by the PROFINET controller/engineering.

5 Configuration

5.1 Representation of an EtherCAT slave on PROFINET

This section is intended to help explain the description of EtherCAT devices on another fieldbus system and to obtain the corresponding information from the existing EtherCAT documentation. In the following terms are explained for a better understanding.

• Introduction

EtherCAT devices such as EL terminals (ES, ELX, ELM), EP modules (ER, EQ, EPP) are EtherCAT slave devices that always consist of process data and, if necessary, parameter data. As a rule, digital EtherCAT devices have no configuration data. Complex EtherCAT devices usually always.

• Process data (PDO, process data object)

Almost all EtherCAT devices have process data¹⁾ that can be from 2 bits and up to several 100 bytes in size. With complex EtherCAT devices, different structures and process data sizes can also be specified. These are so-called Predefined PDOs.

The Predefined PDOs must be specified by the EtherCAT (EC) Master and must be known or set here when the EC Master is started. There is always a Default Predefined PDO. Depending on the higher-level bus system used, the PDO mapping can be set on the EC coupler via the higher-level fieldbus system (as with PROFINET or PROFIBUS) or a configuration page (http protocol, as with ModbusTCP or EtherNet/IP).

¹⁾ Except for e.g. the EK1100 coupler, which has neither process data nor configuration data, it is equipped with an EtherCAT ASIC and is therefore also visible in the EtherCAT network without process data.

• Parameter data (COE)

The parameter data of an EC slave is transmitted via COE (CAN over EtherCAT). As with CAN, it is divided into objects, subobjects and data. Parameter data is, for example, data that sets the resistance value for an EL3202 terminal, i.e., a temperature resistance terminal, such as PT100, PT1000, NI100, and so on.

Only the application-specific COE data is made available at the EK coupler. Depending on the higher-level bus system, all or only some COE objects can be accessed here.

Here, too, parameterization can take place via a web page (http protocol) in the EK.

PROFINET

• Process data

PROFINET devices (Slaves) must bring a GSDML file with them. In this GSDML the devices are described (Download: [configuration file](#)). The EK9300 is a device with a modular structure. It consists of a head station (EK9300) and a number of EtherCAT devices that are connected to the EP9300. This file (GSDML) must then be integrated into the PROFINET controller. If this has been done, the coupler and the EtherCAT Terminals can now be integrated and the appropriate settings made.

• How do I get a description of the EtherCAT process data?

The predefined PDOs usually consist of different PDOs and are a compilation of different PDOs of the process image.

In the following, this is illustrated with the TwinCAT automation software:

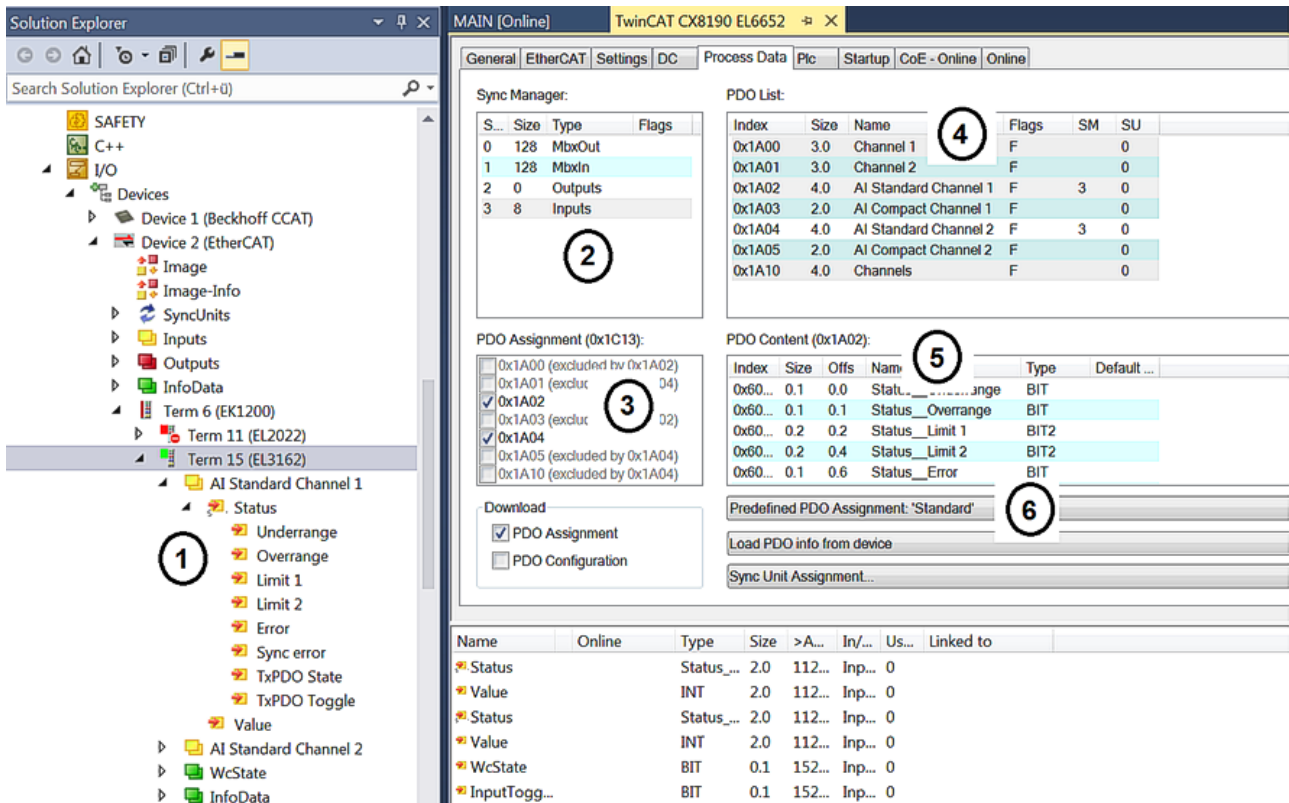

Fig. 16: Typical configuration page of an EtherCAT Terminal

Key:

1. The EtherCAT Terminal is inserted in the TwinCAT tree and has process data that can be linked to the PLC program.
2. View of the existing process data in bytes (exactly this number and size can be seen with PROFINET and the Siemens control, Siemens does not show the process data in more detail although it is described in the GSDML)
3. Display which PDOs are active in the process data
4. View of all PDOs
5. Detail of individual PDOs that can be selected in "4"
6. Predefined PDOs

In the GSDML only the predefined PDOs are selectable (6). If a different combination of PDOs is desired, this can only be done via a Beckhoff controller, such as the CX8093, which has a default PROFINET interface and is programmable with TwinCAT 2 (with TwinCAT 3 a CX9020 with B930 interface is required, or any Beckhoff controller with an EL6631-0010).

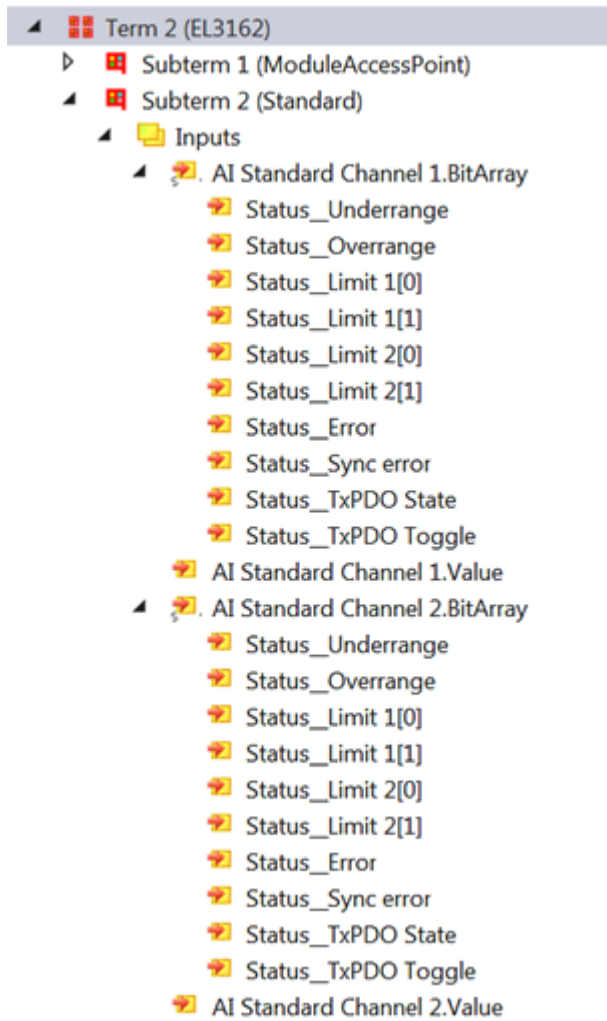

Fig. 17: Example mapping of an EL3162 m standard format (8 byte IN / 0 byte OUT)

Name	Size (variable)	Bit offset
AI Standard Channel 1.BitArray		
Status_Underrange	BIT (BOOL)	0.0
Status_Ovrange	BIT (BOOL)	0.1
Status_Limit_1[0]	BIT (BOOL)	0.2
Status_Limit_1[0]	BIT (BOOL)	0.3
Status_Limit_1[0]	BIT (BOOL)	0.4
Status_Limit_1[0]	BIT (BOOL)	0.5
Status_Error	BIT (BOOL)	0.6
Status_Sync error	BIT (BOOL)	1.5
Status_TxPDO State	BIT (BOOL)	1.6
Status_TxPDO Toggle	BIT (BOOL)	1.7
AI Standard Channel 1.Value	16 BIT (INT)	2.0..3.7
AI Standard Channel 2.BitArray		
Status_Underrange	BIT (BOOL)	4.0
Status_Ovrange	BIT (BOOL)	4.1
Status_Limit_1[0]	BIT (BOOL)	4.2
Status_Limit_1[0]	BIT (BOOL)	4.3
Status_Limit_1[0]	BIT (BOOL)	4.4
Status_Limit_1[0]	BIT (BOOL)	4.5
Status_Error	BIT (BOOL)	4.6
Status_Sync error	BIT (BOOL)	5.5
Status_TxPDO State	BIT (BOOL)	5.6
Status_TxPDO Toggle	BIT (BOOL)	5.7
AI Standard Channel 2.Value	16 BIT (INT)	6.0..7.7

Parameter data

In the following, the parameter or configuration data will be explained. Most of the necessary configuration data is contained in the GSDML; Beckhoff uses the same names and meanings here as on the EtherCAT side, which is contained in the ESI file²⁾ in the CoE description.

Index	Name	Flags	Value	Unit
6010:0	AI Inputs Ch.2	RO	> 1 <	
8000:0	AI Settings Ch.1	RW	> 33 <	
800...	Enable user scale	RW		
800...	Presentation	RW		
800...	Siemens bits	RW		
800...	Enable filter	RW		
800...	Enable limit 1	RW		
800...	Enable limit 2	RW		
800...	Enable user calibration	RW		
800...	Enable vendor calibration	RW		
800...	Swap limit bits	RW		
800...	User scale offset	RW		
800...	User scale gain	RW		
800...	Limit 1	RW		
800...	Limit 2	RW		
800...	Filter settings	RW		
800...	User calibration offset	RW		
800...	User calibration gain	RW		

Fig. 18: EtherCAT: Parameter data of the EL3162 of the ESI under TwinCAT

Name	R/W	Offline Value
Enable user scale	R/W	False
Data Presentation	R/W	Signed
Siemens bits	R/W	False
Enable filter	R/W	False
Enable limit 1	R/W	False
Enable limit 2	R/W	False
Enable user calibr...	R/W	False
Enable vendor cal...	R/W	True
Swap limit bits	R/W	False
User scale offset	R/W	0
User scale gain	R/W	65536
Limit 1	R/W	0
Limit 2	R/W	0
Filter settings	R/W	50 Hz FIR
User calibration o...	R/W	0
User calibration g...	R/W	0

Fig. 19: PROFINET: Parameter data of the EL3162 of the GSDML under TwinCAT

²⁾ The ESI file is the description file for EtherCAT masters (ESI EtherCAT slave information).

Parameter data of the EL3162 of the GSDML under TwinCAT

These parameters for the individual terminals can also be found in the configuration tool of your PROFINET controller, regardless of which manufacturer you use here. You can also access individual parameters acyclically via PROFINET and the record data. To do this, the PROFIENT controller must have an interface to the record data. A CoE protocol description and how it can be used via PROFINET is described in the [EK9300 manual](#).

5.2 EK9300 configuration

i GSDML file

Only terminals that are present in the GSDML file are supported, but extensions are possible. The GSDML supports submodules, check with your PROFINET master/controller if it supports submodules. If this is not the case, some terminals cannot be used!
Alternatively the CX8093 can be used; this generally supports all EtherCAT slaves.

General

The EK9300 PROFINET coupler is always implemented with the help of a GSDML file in the controller (master). The GSDML file contains all parameterization data necessary for the operation of the coupler on the controller. The configuration tool reads this file and then provides the data to the user.

The respective terminals that are usable on the EK9300 are also specified in the GSDML file. Not all EtherCAT terminals are supported. Therefore, ascertain beforehand whether the terminals that you wish to use are also supported by the coupler.

Status and Ctrl. flags

PnloBoxState and PnloBoxDiag can be used to monitor and evaluate the current status of PROFINET communication.

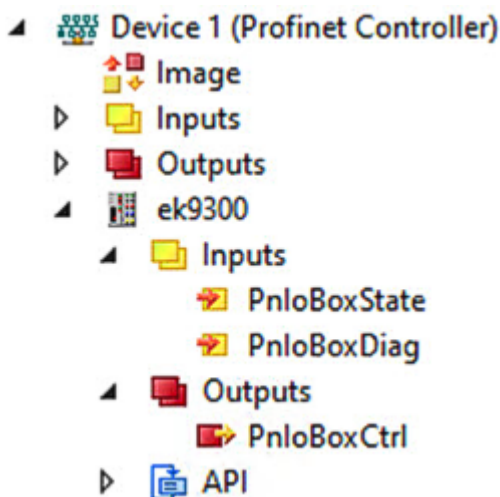

Fig. 20: Evaluation via PnloBoxState and PnloBoxDiag

PnloBoxState	Comment	Meaning
0	No Error	No error
1	PROFINET Device state machine is in boot mode	PROFINET DeviceStateMachine is in the start-up phase
2	Device not found	Device does not reply to the Identify Request
3	The station name is not unique	The station name is not unique
4	IP could not be set	IP address could not be set
5	IP conflict	An IP conflict has occurred in the network
6	DCP set was not successful	There was no reply or an erroneous reply to a DCP set
7	Watchdog error	The connection was broken off with a Watchdog error
8	Datahold error	The connection was broken off with a Datahold error
9	RTC3: Sync signal could not be started	Only the IRT: the Sync signal could not be started
10	PROFINET Controller has a link error	The PROFINET controller has no link
11	The alias name is not unique	The alias name is not unique
12	The automatic name assignment is not possible - wrong device type	Automatic name assignment is not possible - wrong device type
13	IOC-AR is established but no application ready	The IOC-AR is established, the application is not ready
14	IOC-AR is established but module difference	The IOC-AR is established, but there is a module difference
15	At least one InputCR is invalid, provider in stop or problem indicator is set	At least one InputCR is invalid, provider in stop or problem indicator is set
16	At least one OutputCR is invalid, provider in stop or problem indicator is set	At least one OutputCR is invalid, provider in stop or problem indicator is set
31	only for EtherCAT gateways: WC-State of cyclic EtherCAT frame is 1	Only for EL663x-00x0: EtherCAT WC State is set to 1

PnloBoxDiag	Comment	Meaning
0x0000	No Diagnosis	No diagnosis
0x0001	IOC-AR is not established	The IOC-AR is not established
0x0002	IOC-AR is established	The IOC-AR is built
0x0004	IOC-AR is established but no application ready	The IOC-AR is established, the application is not ready
0x0008	0x0008 = IOC-AR is established but module difference	The IOC-AR is established, but there is a module difference
0x0010	At least one AlarmCR got a diagnosis alarm	At least one AlarmCR has received a diagnostic alarm
0x0100	At least one InputCR is invalid	At least one InputCR is invalid
0x0200	At least one InputCR provider is in stop	At least one InputCR provider is in stop
0x0400	At least one InputCR problem indicator is set	At least one InputCR problem indicator is set
0x1000	At least one OutputCR is invalid	At least one OutputCR is invalid
0x2000	At least one OutputCR provider is in stop	At least one OutputCR provider is in stop
0x4000	At least one OutputCR problem indicator is set	At least one OutputCR problem indicator is set

PnloBoxCtrl	Comment	Meaning
0x0001	EBus reset	EBus reset at EK9300/EP9300

Data in the DAP (Device Access Point)

2 x 2 bytes of data are located in the DAP of the GSDML file.

This is once the ECCycleCounter (2 bytes). This is incremented on each EtherCAT cycle (1 ms), provided that the EC master is in the "OP" state.

The status (2 BYTE) is located at the DAP. This indicates individual status information bit by bit. These are currently occupied as follows:

- Bit 0 – IsSynchron – this is set if it is used as a PTP slave or IRT device and is synchronous.
- Bit 1 – IsPTPMaster – this is set if the EK9300 is operated as the PTP master.
- Bit 2 – ECFrameError – this is set if an EtherCAT problem is determined. In order to obtain further information about this, the PROFINET diagnosis or the alarms must be read out.

Parameters in the DAP

Activate PN reset value – *Off* -> EtherCAT data are written to zero. *On* -> there is a possibility to use another default value with outputs. With digital outputs, for example, the current output process value can be frozen or set to 0 or 1 in case of a PROFINET communication error.

Data presentation – *Intel Format* data are represented in Intel format, *Motorola Format* data are represented in Motorola format. In Word variables, for example, the high and low bytes are exchanged.

EBus error behavior – *Set IOs to 0* -> input and output data are set to zero in case of an EC error. *Legacy* -> input data retain their last state, but are no longer updated; output data can still be set (depending on the position of the terminal).

Mapping

Typically the coupler is used in a group with terminals that are connected to the coupler. The terminals are part of the GSDML; the terminals are parameterized from the PROFINET controller.

The mapping is card-slot-oriented, i.e. you must enter the terminals in the hardware configurator in exactly the same way as they are physically connected. It becomes a little more complicated if EtherCAT distribution boxes are used. In this case it is important to know the order in which the other EtherCAT terminals were entered into the process image (see [EtherCAT Mapping \[▶ 53\]](#)).

● Behavior when starting the bus coupler

I All EtherCAT devices must always be present when starting (or resetting) the Bus Coupler. This means that all EtherCAT slaves must be supplied with voltage before or at the same time so that the coupler starts up properly on the PROFINET.
A solution can be constructed more flexibly with the CX8093.

Configuration of the EtherCAT devices

There are 4 types of EtherCAT devices:

- EtherCAT devices without process data
- EtherCAT devices with “simple” process data but without parameterization (usually simple digital terminals)
- EtherCAT devices with “simple” process data and with parameters (usually analog signals)
- EtherCAT devices with different process data and parameters (for example incremental encoders)

All of these must be entered in the configuration.

Grouping digital inputs and outputs (pack terminals)

The digital input and output terminals can also be grouped according to their process data. This option can be used with 2 or 4-channel terminals. To do this a 2 or 4-channel pack terminal (without asterisk) must be appended to the GSDML file. In order to fill the byte, a 2 or 4-channel pack terminal (with asterisk) must be appended next. The terminals must be physically and systematically plugged in one behind the other or logically. The byte limit must not be exceeded.

Sample:

2-channel pack (without asterisk), after that 3 modules from 2-channel pack terminals (with asterisk) may be appended.

Not permitted:

2-channel pack (without asterisk), then 2 modules from 4-channel pack terminals (with asterisk). This exceeds the byte limit.

EtherCAT terminals with different mapping options

Some EtherCAT terminals offer the option to represent different process data. These are represented differently on the basis of the parameters. In the PROFINET controller such a terminal is represented by submodules. The standard mapping is always integrated. If you want to use a different mapping that deviates from the standard, then delete the standard submodule and insert the one that you wish to use. It may be the case that, contradictory to the documentation for the EtherCAT terminal or EtherCAT box, not all mappings can be used under the PROFINET coupler.

Example of an EL5101:

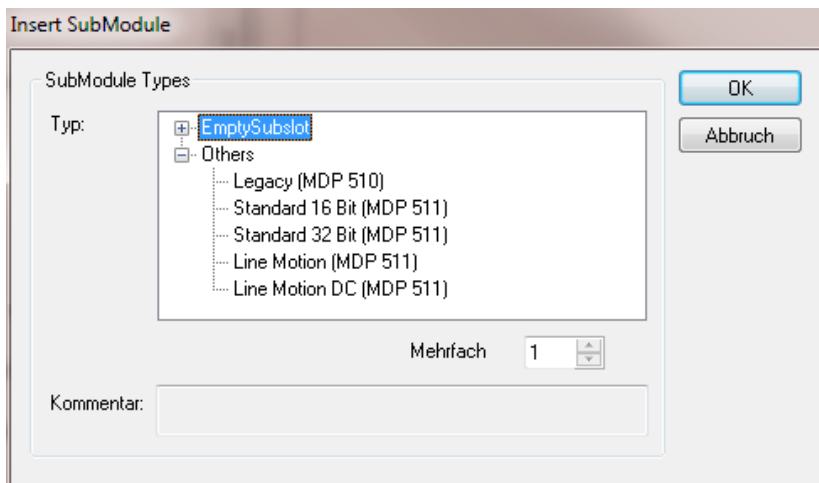

Fig. 21: Inserting a sub-module

EtherCAT gateway terminals

The gateway terminals support several submodules; the first or basic module is loaded immediately, the modules for the process data must be created. These must then also be parameterized on the master side of the corresponding gateway. Not all features of a gateway terminal can be used on the EK9300.

EL6631-0010

The PROFINET device terminal enables two different PROFINET networks to be connected; only one device interface is supported on the EK. A default station name can be assigned and IP settings made via parameterization data (GSDML). Note that the complete maximum data length of the EL6631-0010 cannot be used. The length is dependent on the other EtherCAT devices attached to the EK9300.

EL6731-0010

The PROFIBUS slave terminal enables communication with a PROFIBUS master. The PROFIBUS address is specified via the parameter settings (in the GSDML) in the terminal. Only pure process data can be exchanged.

EL6692

The EtherCAT slave terminal enables communication with a EtherCAT master. Only pure process data can be exchanged.

EL6652-0010

The EtherNet/IP slave terminal enables communication with an EtherNet/IP master; only one slave interface is supported on the EK. The IP address and subnet mask are specified via the parameter settings (in the GSDML) of the terminal. Only pure process data can be exchanged. The terminal on the EK supports only one slave interface.

5.3 EK9300 EtherCAT configuration

The EK9300 is an EtherCAT master with automatic configuration, i.e. all EtherCAT terminals must always be present when switching on the system. Since the boot-up of the EK9300 generally takes considerably longer than the start-up of the EtherCAT slave devices, the latter can be operated on the same power supply. With decentralized EtherCAT slaves, care must be taken that they are switched on earlier or at the same time as the supply voltage.

Switching EtherCAT devices on or off during the runtime

If one or more EtherCAT devices should fail during the operating phase, a plug alarm is sent; the EK9300 remains in data exchange. The input data of all EtherCAT devices are invalid and are set to FALSE or ZERO; the output data are no longer accepted. This also applies to the devices that are still in operation on the EK9300. If you wish to use the option to plug in or unplug devices during the runtime, a further "Sync Unit" must be configured. This is not possible with an EK9300. In this case use a CX8093.

EtherCAT devices that don't exist in the GSDML

Some EtherCAT Slaves are not included in the GSDML and thus cannot be used (yet). The CX8093 can be used here, since it supports all EtherCAT devices in principle.

EtherCAT topology

All EtherCAT devices must be entered in the order in which they map themselves on the EK9300 and thus on the EtherCAT master. EtherCAT devices are addressed automatically; with a few exceptions all EtherCAT Bus Terminals are equipped with an EtherCAT ASIC, which has to be entered in the system, i.e. the PROFINET controller. EtherCAT Terminals without an ASIC are, for example, EL9400, EL9070 and other EL9xxx. You can identify these EtherCAT Terminals using the technical data "Message to E-bus". If there is a "-" here, this terminal does not have to be entered in the PROFINET controller.

EtherCAT devices are registered in the direction of the EtherCAT telegram.

Sample configuration with EK1100 EtherCAT coupler

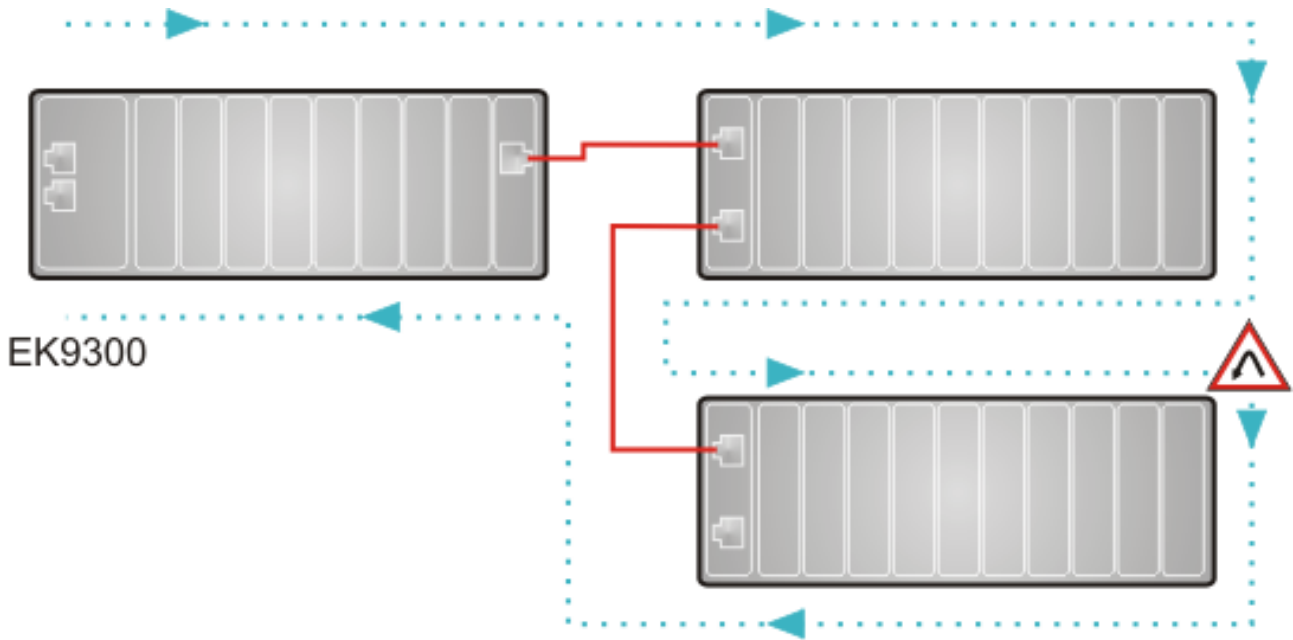



-  End point for the EtherCAT counting direction
-  Direction of the EtherCAT frame
-  Cable

Fig. 22: Sample configuration with EK1100 EtherCAT coupler

Sample configuration with EPxxxx EtherCAT Box



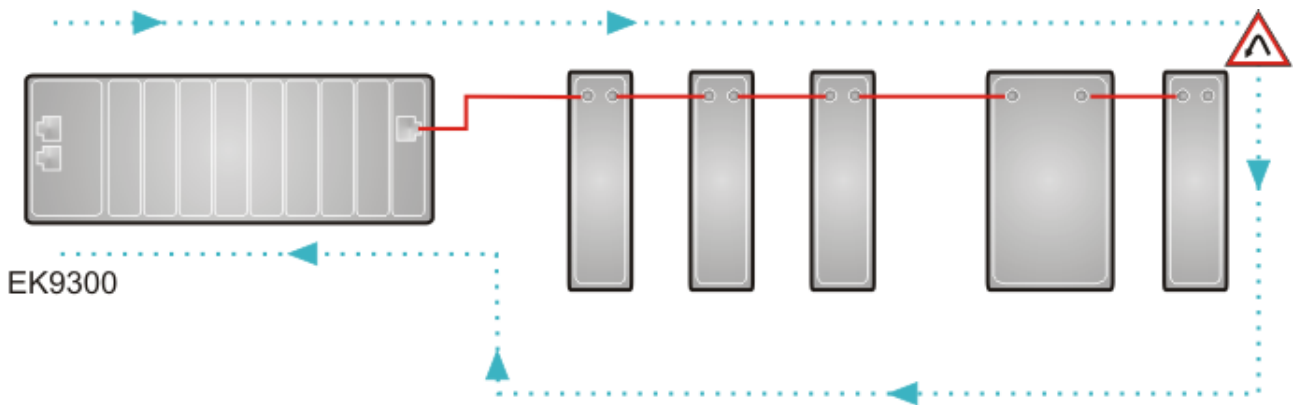

-  End point for the EtherCAT counting direction
-  Direction of the EtherCAT frame
- Cable

Fig. 23: Sample configuration with EPxxxx EtherCAT Box

Sample configuration with EK1122 2-port EtherCAT junction

The counting direction is to be observed when using an EK1122. If EtherCAT junction 1 on the EK1122 is connected, then the EtherCAT frame is forwarded here first (1); if junction 1 is not connected the frame on junction 2 is sent (2), only after that does the sequence continue with the E-bus on the right-hand side (3).

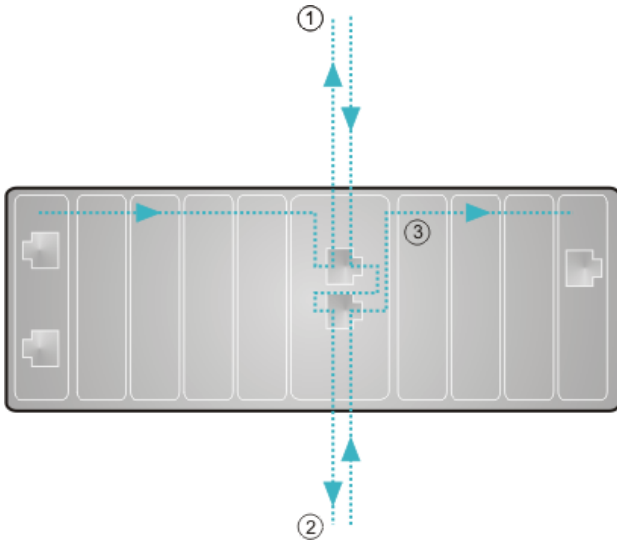

Fig. 24: Sample configuration with EK1122 2-port EtherCAT junction

If both junctions are not used, then junction 1 and 2 are short-circuited as it were and the EC frame continues directly from the terminal to the right.

It must be noted that in the PROFINET controller the modules are entered in the direction of the EtherCAT frame.

Sample configuration with EP1122 2-port EtherCAT junction

The counting direction is to be observed when using an EP1122; it is comparable with the EK1122. If EtherCAT junction 1 on the EP1122 is connected, then the EtherCAT frame is forwarded here first (1); if junction 1 is not connected the frame on junction 2 is sent (2), only after that does the sequence continue with the EC-bus on the right-hand side (3).

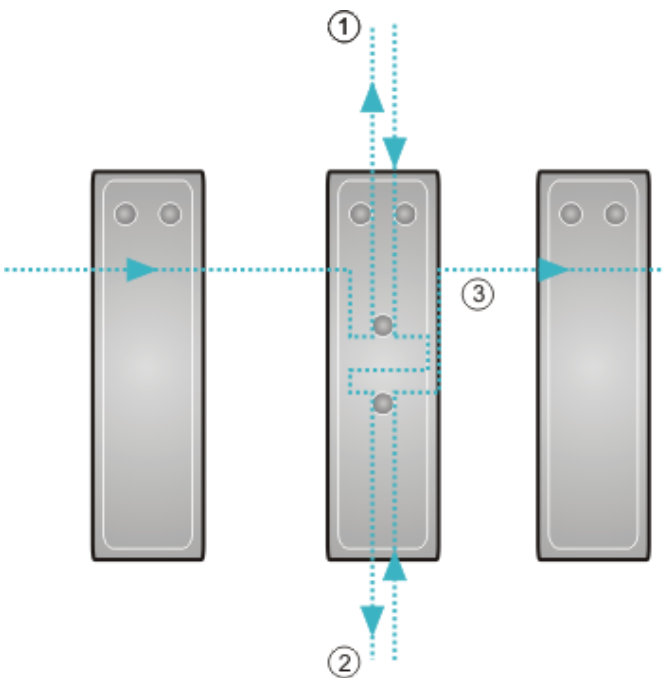

Fig. 25: Sample configuration with EP1122 2-port EtherCAT junction

If both junctions are not used, then junction 1 and 2 are short-circuited as it were and the EC frame continues directly from the terminal to the right.

It must be noted that in the PROFINET controller the modules are entered in the direction of the EtherCAT frame.

● Connection during operation

i You cannot use the EP1122 and EK1122 for Hot Swap or connect or disconnect them during operation. The EP1122 and EK1122 are suitable in conjunction with the EK coupler only as topology extensions (star).

5.3.1 EK9300 Settings

Name	R/W	Offline Value	Online Value
Data Presentation	R/W	Motorola Format	Motorola Format
EBus error behaviour	R/W	Set IOs to 0 without ...	Set IOs to 0 without ...
Set EBus cycle	R/W	1ms	PN cycle
MultiConfigurationMode	R/W	inactive	inactive
Webserver	R/W	inactive	active
PN error behavior	R/W	Set to zero	Set to zero
Acyclic frame prioritization	R/W	inactive	inactive

RecordData to Index 0x2001, Transfer Sequence is 1. If you click 'Set to Default' the whole index will be set to default!

Data Presentation

The data of the coupler is transmitted in Motorola format by default. If your controller requires the data in Intel format, you can use this setting to rotate the process data accordingly.

EBus error behaviour

See chapter [EBus error behaviour](#) [▶ 88]

Set EBus cycle

If there are problems in the establishment of PROFINET communication when using a higher number of complex terminals on the EK9300, the combination of adjusting the "Set EBus Cycle" setting from default "1 ms" to "PN cycle" and adjusting the PN cycle time can provide a remedy. Usually it is sufficient to set the PROFINET cycle time to 2 ms, if necessary to 4 ms.

NOTICE

If the PN Cycle feature is activated and the PROFINET cycle time is set to more than 64 ms, the EtherCAT cycle is still operated with 64 ms so that the internal watchdog of the EtherCAT Terminals (100 ms) does not intervene. This means that if a PN cycle of 128 ms is set in the PROFINET controller, the internal EtherCAT cycle is operated with 64 ms.

MultiConfigurationMode

See chapter [MultiConfigurationMode \[▶ 81\]](#)

Web server

See chapter [Web server \[▶ 89\]](#)

PN error behavior

How the data of the coupler is transferred in case of PROFINET errors can be set via dropdown list.

- **Set to zero (default):** data will all be set to "0"
- **Defined fallback:** data is set to a defined value.
- **Frozen:** data is frozen to the value you have at the moment of the error.
- **Stop Ebus:** Another EtherCAT frame passes the coupler and its devices. The EtherCAT state machine is in "INIT"

Acyclic frame prioritization

If required by the application, acyclic frames (record data) can be prioritized.

5.4 EK9300 – Configuration example

PDO Mapping

The process data on the EtherCAT side is described via the PDO mapping. The individual terminals bring along a pre-defined PDO mapping, i.e. a practical combination of individual PDOs, via the ESI file (EtherCAT description file).

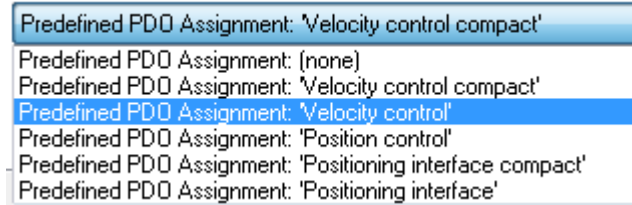

Fig. 26: EK9300 - Predefined PDO selection dialog

These combinations are described in turn on the Profinet side using different submodules and thus process data; i.e. each pre-defined PDO mapping has an associated submodule.

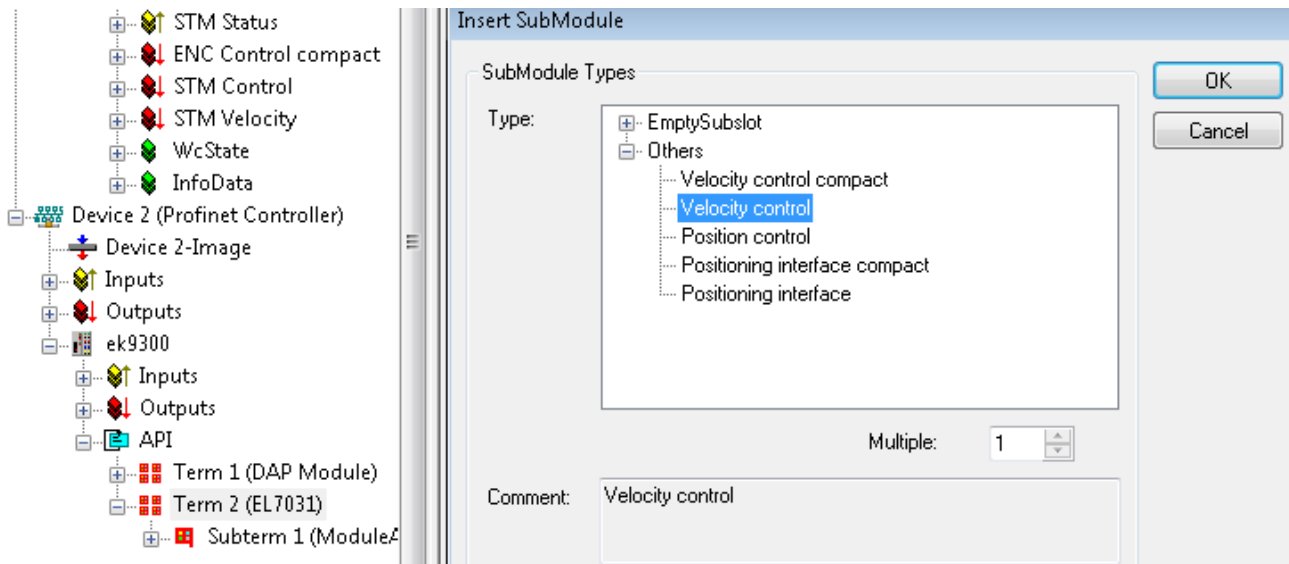

Fig. 27: EK9300 submodules

Such modular terminals always have a fixed submodule plugged into subslot 1 on the EK9300. This is the placeholder for the terminal itself; i.e. the generally valid diagnosis for the terminal is operated via this. The actual process data is plugged into subslot 2 and the PDO mapping on the EC-master is generated on its basis.

SDO Mapping

Each of the plugged-in subslots can bring along parameterization data. The Service Data Objects (SDOs) are transmitted via these data, i.e. the SDOs are mapped to record data sets. The objects 0x8xxx and 0xF8xx are always mapped. Since the indices on the PROFINET side are only vendor-specific from 0 - 0x7FFF, the EtherCAT objects 0x8xxx correspond to the PROFINET record indices 0x3xxx and the EC objects 0xF8xx to the PROFINET index range 0x48xx. In PROFINET the records are always written during the controller start-up phase; they are transferred internally to the EtherCAT master as start-up SDOs. This means that the internal EC master is also restarted during a PROFINET restart.

General		Parameterize Module		
[-] ECStavelnitValues		Name	R/W	Offline Value
[-] Index 0x2009		Operation mode	R/W	Automatic
[-] ENC Settings Ch.1		Speed range	R/W	2000 Fullsteps/sec
[-] Index 0x3000		Invert motor polarity	R/W	False
[-] STM Motor Settings Ch.1		Select info data 1	R/W	Motor coil current A
[-] Index 0x3010		Select info data 2	R/W	Motor coil current B
[-] STM Controller Settings Ch.1		Invert digital input 1	R/W	False
[-] Index 0x3011		Invert digital input 2	R/W	False
[-] STM Features Ch.1		Function for input 1	R/W	Normal input
[-] Index 0x3012		Function for input 2	R/W	Normal input
[-] STM Controller Settings 2 Ch.				
[-] Index 0x3013				
[-] PDS Settings Ch.1				
[-] Index 0x3020				
[-] PDS Features Ch.1				
[-] Index 0x3021				

Fig. 28: PROFINET record indices 0x3xxx (corresponds to EtherCAT objects 0x8xxx)

These data records can also be read and written during operation.

Commissioning EL7031

The default settings are adequate for initial commissioning, i.e. only the corresponding submodule needs to be selected. The PDOs and SDOs of the terminal are parameterized on that basis. For example, if the "Velocity Control" submodule is selected, only the *Control_Enable* bit needs to be set; subsequently turn the motor by specifying a setpoint speed.

5.4.1 Commissioning EL72x1-xxxx

The EK9300 supports the servo terminals with the "Drive Motion Control" mode. This mode enables an axis to move independently to a position assigned from the process data. The setpoint calculations, which are usually done by the NC, are done in DMC mode by the terminal itself.

The commissioning of an EL7201-0010 on the EK9300 is to be shown by means of an example.

Requirement:

- Min. EK9300 firmware version "14(V0.59)"
- Min. GSDML Version "GSDML-V2.34-BECKHOFF-EK9300-20190904.XML"
- Min. EL72xx-xxxx firmware version 19
- Min. EL72xx-xxxx esi version 30

Hardware used

- EK9300 with firmware version 14(V0.59)
- EL7201-0010 with firmware version 19 and EL7201 ESI File EL7201-0010-9999.xml
- ZK4704-0401-0000 (motor cable)
- AM8112-0F20-0000

Configuration

First, the EK9300 and the EL7201-0010 must be added to the configuration. See: [Appending PROFINET devices](#)

To ensure that the terminal uses the correct motor, it is recommended to read the motor name plate with the terminal. For this the parameter entries "Enable auto config", "Reconfig identical motor" and "Reconfig non-identical motor" in the parameter settings "FB OCT SettingsCh1 - Index 0x3008" of the terminal must be changed to "TRUE".

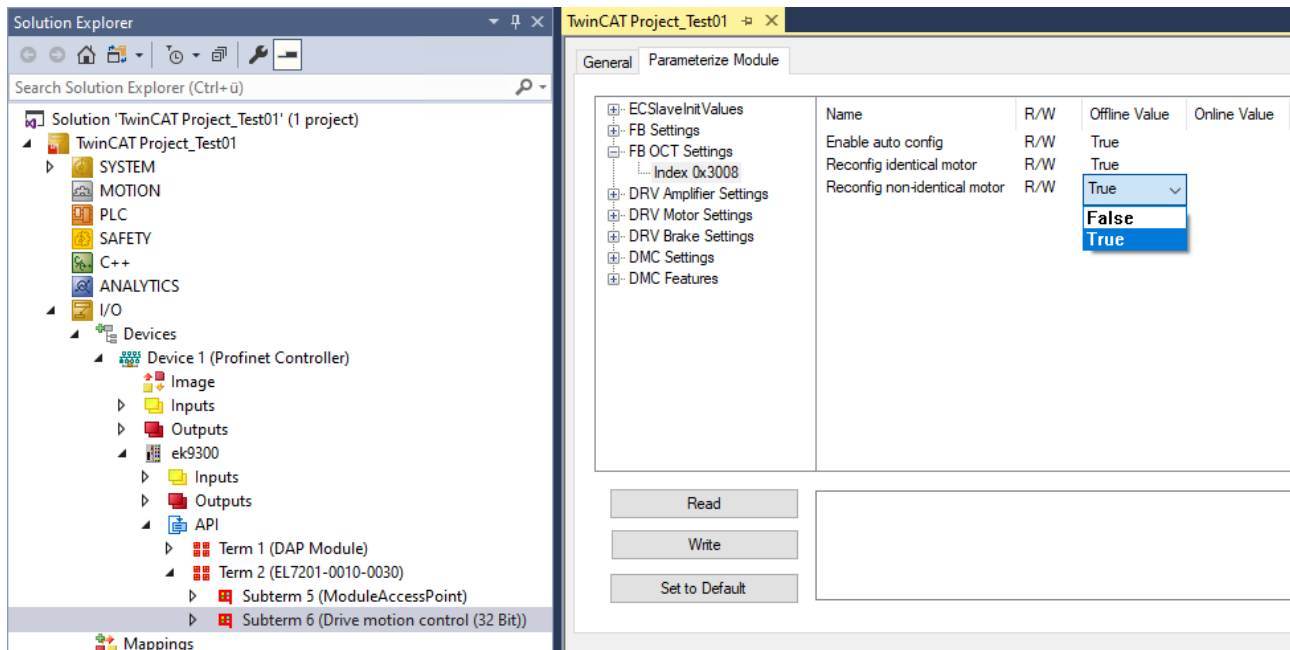

Fig. 29: Parameter settings for automatic readout of the motor name plate used

The terminal reads the name plate of the motor and sets the motor-specific parameters automatically. The default motor settings are not used any further and can be read back if required.

Mapping of the EL7201-0010 in "Drive Motion Control" format

INPUTS (64 bytes):

Name	Size (variable)	Bit offset
DMC Inputs.FeedbackStatus (16-bit array)		
Latch extern valid	BIT (BOOL)	0.1
Set counter done	BIT (BOOL)	0.2
Status of extern latch	BIT (BOOL)	1.4
DMC Inputs.DriveStatus (16-bit array)		
Ready to enable	BIT (BOOL)	2.0
Ready	BIT (BOOL)	2.1
Warning	BIT (BOOL)	2.2
Error	BIT (BOOL)	2.3
Moving positive	BIT (BOOL)	2.4
Moving negative	BIT (BOOL)	2.5
Digital input 1	BIT (BOOL)	3.3
Digital input 2	BIT (BOOL)	3.4
DMC Inputs.PositioningStatus (16-bit array)		
Busy	BIT (BOOL)	4.0
In-Target	BIT (BOOL)	4.1
Warning	BIT (BOOL)	4.2
Error	BIT (BOOL)	4.3
Calibrated	BIT (BOOL)	4.4
Accelerate	BIT (BOOL)	4.5
Decelerate	BIT (BOOL)	4.6
Ready to execute	BIT (BOOL)	4.7
DMC Inputs.Set position	DWORD (32-bit)	6-9
DMC Inputs.aligned [0]	DWORD (32-bit)	10-13
DMC Inputs.Set velocity	WORD (16-bit)	14-15
DMC Inputs.Actual drive time	DWORD (32-bit)	16-19
DMC Inputs.Actual position lag	DWORD (32-bit)	20-23
DMC Inputs aligned [1]	DWORD (32-bit)	24-27
DMC Inputs.Actual velocity	WORD (16-bit)	28-29
DMC Inputs.Actual position	DWORD (32-bit)	30-33
DMC Inputs.aligned [2]	DWORD (32-bit)	34-37
DMC Inputs.Error Id	DWORD (32-bit)	28-41
DMC Inputs.Input cycle counter	Byte (8 bit)	42
DMC Inputs.aligned [3]	Byte (8 bit)	43
DMC Inputs.Latch value input	DWORD (32-bit)	44-47
DMC Inputs.aligned [4]	DWORD (32-bit)	48-51
DMC Inputs. Cycle info data1	WORD (16-bit)	52-53
DMC Inputs.Cycle info data2	WORD (16-bit)	54-55
DMC Inputs.aligned [5]	LWORD (64-bit)	56-63

OUTPUTS (40 bytes):

Name	Size (variable)	Bit offset
DMC Outputs.FeedbackControl (16-bit array)		
Latch extern valid	BIT (BOOL)	0.1
Set counter done	BIT (BOOL)	0.2
Status of extern latch	BIT (BOOL)	1.4
DMC Outputs.DriveControl (16-bit array)		
Enable	Bit (BOOL)	2.0
Reset	Bit (BOOL)	2.1
DMC Outputs.PositioningControl (16-bit array)		
Execute	BIT (BOOL)	4.0
Emergency Stop	BIT (BOOL)	4.1
DMC Outputs.Set counter value	DWORD (32-bit)	6-9
DMC Outputs.aligned [0]	DWORD (32-bit)	10-13
DMC Outputs.Target position	DWORD (32-bit)	14-17
DMC Outputs.aligned [0]	DWORD (32-bit)	18-21
DMC Outputs.Target velocity	WORD (16-bit)	22-23
DMC Outputs.Start Type	WORD (16-bit)	24-25
DMC Outputs.Target acceleration	WORD (16-bit)	26-27
DMC Outputs.Target deceleration	WORD (16-bit)	28-29
DMC Outputs.aligned [0]	10 bytes	30-39

Program sequence

- At the beginning it must be ensured that the EK9300 is in data exchange.
 - The diagnostics in TwinCAT, the status process data or the LEDs of the EK9300 can be used for this purpose.
- As soon as the EK9300 is in data exchange, the connected EL7201-0010 can be checked for correct function.
 - For this purpose, the error bits in the "Drive" and "PositioningStatus" are checked. If both status bits are equal to "FALSE", the "Ready to enable" bit under "DriveStatus" is checked. If this is equal to "TRUE" the "Enable bit" under "DriveControl" can be set.
- If the "Ready to execute" bit equals "TRUE", the first motion command can be started.
 - For this, the position¹⁾ must be set via "DMC Outputs.Target position", the velocity²⁾ via "DMC Outputs.Target velocity", the starting acceleration³⁾ via "DMC Outputs.Target acceleration" and the deceleration³⁾ via "DMC Outputs.Target deceleration" as well as the start type⁴⁾ can be transferred to the terminal via "DMC Outputs.Start Type".
- The "Execute" bit under "DriveControl" starts and executes the command.
- The "Busy" bit under "DriveStatus" remains "TRUE" until the motion command has been processed.
 - If the axis is in position, this is signaled by the "In-Target" bit. Furthermore the bit "Busy" changes from "TRUE" to "FALSE".
- As soon as the "Busy" bit changes to "FALSE", the "Execute" bit must be set to "FALSE" by the user.
 - If "Execute" is set to "FALSE" while "Busy" equals "TRUE", the current motion command is interrupted and the axis stops.
- To transfer a new motion command, the "Ready to execute" bit must be checked again.

¹⁾ The position of one revolution is $0x0010_0000 \cdot 2^{20}$

²⁾ The velocity is given in 0.01 % of the maximum velocity; $1000 = 10 \%$

³⁾ The acceleration ramp is given in ms; $1000_{(dec)} = 1 \text{ sec}$

⁴⁾ see table

ABSOLUTE	0x0001	Absolute positioning to a specific target position
RELATIVE	0x0002	Relative positioning to a calculated target position; a specified position difference is added to the current position
ENDLESS_PLUS	0x0003	Endless travel in the positive direction of rotation (direct specification of a velocity)
ENDLESS_MINUS	0x0004	Endless travel in the negative direction of rotation (direct specification of a velocity)
MODULO_SHORT	0x0105	Modulo positioning along the shortest path to the modulo position (positive or negative), calculated by the "modulo factor"
MODULO_PLUS	0x0205	Modulo positioning in the positive direction of rotation to the calculated modulo position
MODULO_MINUS	0x0305	Modulo positioning in the negative direction of rotation to the calculated modulo position
CALI_PLC-CAM	0x6000	Start a calibration with cam (digital inputs)
CALI_ON_BLOCK	0x6200	Start a calibration "on block".
CALI_SET_POS	0x6E00	Set as calibrated, do not change position
CALI_CLEAR_POS	0x6F00	Delete calibration bit

● Creating a task for commissioning via TwinCAT

i For commissioning via TwinCAT with our PROFINET controllers, a separate task must be created for the outputs, otherwise the values will not be processed correctly.

Servo terminal with STO input:

If the terminal in use is to have an STO input, this can lead to an error if it is not supplied with power.

A distinction must be made here between two cases, i.e. which error occurs.

- The STO input of the terminal is not supplied with 24 V and the axis is to be switched on. This case is signaled by a "TRUE" at the "Warning Bit" under "DriveStatus" and by a warning in the "DiagHistory" in TwinCAT. This message cannot be read in the TIA portal.
- The voltage at the STO input of the terminal drops during operation. Thereafter, the error bit "Error" under "DriveStatus" should change to "TRUE" and under "Error ID" the value 0x841C_{hex} or 33820_{dec} should be displayed.

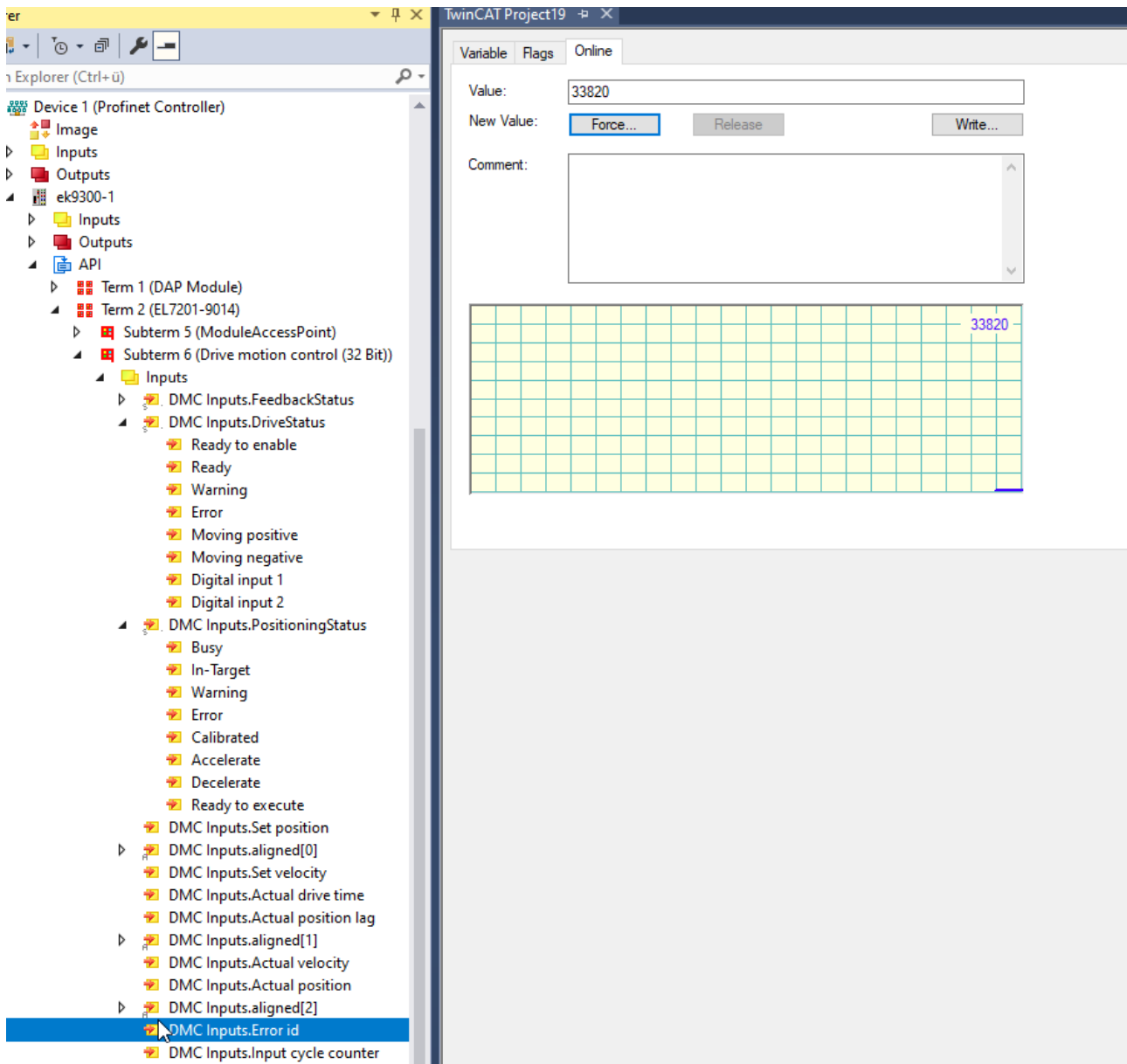

Fig. 32: Display of the Error ID if the STO input is absent

It is possible to show the state of the STO input in the process data. For this purpose, the option "Input level" must be selected in the parameter settings of the terminal under "DRV Amplifier Settings Ch. 2 - Select Info data x". The state is then displayed in the eighth bit of the "Cyclic info data x".

General		Parameterize Module		
[-] ECSlaveInitValues	Name	R/W	Offline Value	Online Value
[-] FB Settings Ch.1	Enable TxPDOToggle	R/W	False	False
[-] FB OCT Settings Ch.1	Enable input cycle counter	R/W	False	False
[-] DRV Amplifier Settings Ch.2	Device type	R/W	1	1
[-] Index 0x3010	Current loop integral time	R/W	10	10
[-] DRV Motor Settings Ch.2	Current loop proportional gain	R/W	100	100
[-] DRV Brake Settings Ch.2	Velocity loop integral time	R/W	50	50
[-] DMC Settings Ch.4	Velocity loop proportional g...	R/W	150	150
[-] DMC Features Ch.4	Position loop proportional g...	R/W	10	10
	Nominal DC link voltage	R/W	48000	48000
	Min DC link voltage	R/W	6800	6800
	Max DC link voltage	R/W	60000	60000
	Amplifier I2T warn level	R/W	80	80
	Amplifier I2T error level	R/W	105	105
	Amplifier Temperature warn...	R/W	800	800
	Amplifier Temperature error ...	R/W	1000	1000
	Velocity limitation	R/W	262144	262144
	Short-Circuit Brake duration...	R/W	1000	1000
	Stand still window	R/W	5	5
	Select info data 1	R/W	Input level	Input level
	Select info data 2	R/W	Torque current (filter...	Torque current (filter...
	Low-pass filter frequency	R/W	320	320
	Halt ramp deceleration	R/W	62832	62832
	Following error window	R/W	4294967295	4294967295
	Following error time out	R/W	0	0
	Fault reaction option code	R/W	Disable drive functio...	Disable drive functio...
	Feature bits	R/W	0	0
	Velocity feed forward gain	R/W	100	100
	Invert direction of rotation	R/W	False	False
	Enable cogging torque co...	R/W	False	False

Parameter settings for showing the STO input in the process data

Using the EL7201-0010 via the TIA portal

- Configuration
 - Hardware used in this example: Simatic S7-1500 CPU 1516F-3 PN/DP & ES7 516-3FN01-0AB0
 - The hardware required is added under "Device & Networks"

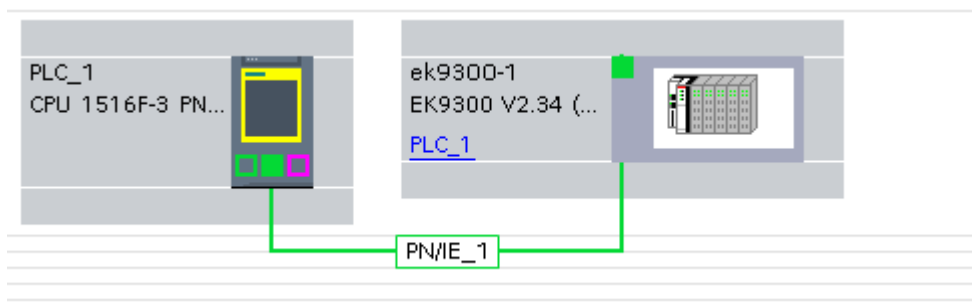

Fig. 33: TIA Portal "Device & Networks" view

- Ensuring error-free communication
 - To check whether communication between the S7-1500 and the EK9300 works without error, the program must first be compiled and loaded onto the controller.

- Subsequently, all LEDs on the EK9300 must light up green. If this is not the case, there is no or faulty communication between the controller and the device. If all LEDs are lit up green, you can connect to the controller via "Go online".
- Assignment of the process data to the respective inputs and outputs
 - First of all, it must be determined which input and output addresses of the EL7201-0010 have been assigned by the TIA portal. To do this, the EK9300 must be selected under "Network View", and the assigned input and output addresses are displayed on the right-hand side.
 - It must then be checked which process data corresponds to which input or output.

Inputs

Name	Size (Variable)	Bit offset
DMC Inputs.FeedbackStatus (16 BitArray)		
Latch extern valid	BIT (BOOL)	0.1
Set counter done	BIT (BOOL)	0.2
Status of extern latch	BIT (BOOL)	1.4
DMC Inputs.DriveStatus (16 BitArray)		
Ready to enable	BIT (BOOL)	2.0
Ready	BIT (BOOL)	2.1
Warning	BIT (BOOL)	2.2
Error	BIT (BOOL)	2.3

Device overview

Module	Rack	Slot	I address	Q address	Type
ek9300	0	0	0...3		EK9300 V2.35 (at I...
EK9300 V2.35 (mind. FW...	0	0 X1			ek9300
EL7201-0010-0032_1	0	1			EL7201-0010-0032
ModuleAccessPoint	0	1 1			ModuleAccessPoint
Drive motion control (32...	0	1 2	4...67	0...39	Drive motion contr...

Outputs

Name	Size (Variable)	Bit offset
DMC Outputs.FeedbackControl (16 Bit Array)		
Latch extern valid	BIT (BOOL)	0.1
Set counter done	BIT (BOOL)	0.2
Status of extern Latch	BIT (BOOL)	1.4
DMC Outputs.DriveControl (16 BitArray)		
Enable	Bit (BOOL)	2.0
Reset	Bit (BOOL)	2.1
DMC Outputs.PositioningControl (16 BitArray)		
Execute	BIT (BOOL)	4.0

Fig. 34: Example process data of the EL7201 in the TIA portal

- In the graphic above, you can see that there is an offset of 4 for the input process data. This means that the process data "DMC Inputs.FeedbackStatus.Latch extern valid" in the TIA portal has the input address "4.1".
- The output process data in this sample have no offset at all; i.e. the "DMC Outputs.FeedbackControl.Latch extern valid" has the output address "0.1".
- Furthermore, the respective byte size of the process data is shown in the graphic.

- To control the assignments of the inputs, the program must be compiled, loaded to the controller and connected online. Subsequently, the variable table must be opened and the observation mode must be activated.
 - If the terminal is connected correctly and there is no error, the input "InputCycleCounterInput" should toggle and the input "ReadyToEnableDriveInput" should be "TRUE".

	Name	Data type	Address	Retain	Acces...	Writa...	Visibl...	Monitor value	Supervisi...
1	LatchExternValidFeedbackInput	Bool	%I4.1	<input type="checkbox"/>	<input checked="" type="checkbox"/>	<input checked="" type="checkbox"/>	<input checked="" type="checkbox"/>	FALSE	
2	SetCounterDoneFeedbackInput	Bool	%I4.2	<input type="checkbox"/>	<input checked="" type="checkbox"/>	<input checked="" type="checkbox"/>	<input checked="" type="checkbox"/>	FALSE	
3	StatusOfExternLatchFeedback...	Bool	%I5.4	<input type="checkbox"/>	<input checked="" type="checkbox"/>	<input checked="" type="checkbox"/>	<input checked="" type="checkbox"/>	FALSE	
4	ReadyToEnableDriveInput	Bool	%I6.0	<input type="checkbox"/>	<input checked="" type="checkbox"/>	<input checked="" type="checkbox"/>	<input checked="" type="checkbox"/>	TRUE	
5	ReadyDriveInput	Bool	%I6.1	<input type="checkbox"/>	<input checked="" type="checkbox"/>	<input checked="" type="checkbox"/>	<input checked="" type="checkbox"/>	FALSE	
6	WarningDriveInput	Bool	%I6.2	<input type="checkbox"/>	<input checked="" type="checkbox"/>	<input checked="" type="checkbox"/>	<input checked="" type="checkbox"/>	TRUE	
7	ErrorDriveInput	Bool	%I6.3	<input type="checkbox"/>	<input checked="" type="checkbox"/>	<input checked="" type="checkbox"/>	<input checked="" type="checkbox"/>	FALSE	
8	MovingPositiveDriveInput	Bool	%I6.4	<input type="checkbox"/>	<input checked="" type="checkbox"/>	<input checked="" type="checkbox"/>	<input checked="" type="checkbox"/>	FALSE	
9	MovingNegativeDriveInput	Bool	%I6.5	<input type="checkbox"/>	<input checked="" type="checkbox"/>	<input checked="" type="checkbox"/>	<input checked="" type="checkbox"/>	FALSE	
10	DigitalInput1DriveInput	Bool	%I7.3	<input type="checkbox"/>	<input checked="" type="checkbox"/>	<input checked="" type="checkbox"/>	<input checked="" type="checkbox"/>	FALSE	
11	DigitalInput2DriveInput	Bool	%I7.4	<input type="checkbox"/>	<input checked="" type="checkbox"/>	<input checked="" type="checkbox"/>	<input checked="" type="checkbox"/>	FALSE	
12	BusyPosInput	Bool	%I8.0	<input type="checkbox"/>	<input checked="" type="checkbox"/>	<input checked="" type="checkbox"/>	<input checked="" type="checkbox"/>	FALSE	
13	InTargetPosInput	Bool	%I8.1	<input type="checkbox"/>	<input checked="" type="checkbox"/>	<input checked="" type="checkbox"/>	<input checked="" type="checkbox"/>	FALSE	
14	WarningPosInput	Bool	%I8.2	<input type="checkbox"/>	<input checked="" type="checkbox"/>	<input checked="" type="checkbox"/>	<input checked="" type="checkbox"/>	FALSE	
15	ErrorPosInput	Bool	%I8.3	<input type="checkbox"/>	<input checked="" type="checkbox"/>	<input checked="" type="checkbox"/>	<input checked="" type="checkbox"/>	FALSE	
16	CalibratedPosInput	Bool	%I8.4	<input type="checkbox"/>	<input checked="" type="checkbox"/>	<input checked="" type="checkbox"/>	<input checked="" type="checkbox"/>	FALSE	
17	AcceleratePosInput	Bool	%I8.5	<input type="checkbox"/>	<input checked="" type="checkbox"/>	<input checked="" type="checkbox"/>	<input checked="" type="checkbox"/>	FALSE	
18	DeceleratePosInput	Bool	%I8.6	<input type="checkbox"/>	<input checked="" type="checkbox"/>	<input checked="" type="checkbox"/>	<input checked="" type="checkbox"/>	FALSE	
19	ReadyToExecutePosInput	Bool	%I8.7	<input type="checkbox"/>	<input checked="" type="checkbox"/>	<input checked="" type="checkbox"/>	<input checked="" type="checkbox"/>	FALSE	
20	SetPositionInput	DWord	%ID10	<input type="checkbox"/>	<input checked="" type="checkbox"/>	<input checked="" type="checkbox"/>	<input checked="" type="checkbox"/>	16#0000_0000	
21	SetVelocityInput	Word	%IW14	<input type="checkbox"/>	<input checked="" type="checkbox"/>	<input checked="" type="checkbox"/>	<input checked="" type="checkbox"/>	16#0000	
22	ActualDriveTimeInput	DWord	%ID16	<input type="checkbox"/>	<input checked="" type="checkbox"/>	<input checked="" type="checkbox"/>	<input checked="" type="checkbox"/>	16#0000_0000	
23	ActualPositionLagInput	DWord	%ID20	<input type="checkbox"/>	<input checked="" type="checkbox"/>	<input checked="" type="checkbox"/>	<input checked="" type="checkbox"/>	16#0000_00F0	
24	ActualVelocityInput	Word	%IW24	<input type="checkbox"/>	<input checked="" type="checkbox"/>	<input checked="" type="checkbox"/>	<input checked="" type="checkbox"/>	16#0000	
25	ActualPositionInput	DWord	%ID26	<input type="checkbox"/>	<input checked="" type="checkbox"/>	<input checked="" type="checkbox"/>	<input checked="" type="checkbox"/>	16#03FF_FF64	
26	ErrorIDInput	DWord	%ID30	<input type="checkbox"/>	<input checked="" type="checkbox"/>	<input checked="" type="checkbox"/>	<input checked="" type="checkbox"/>	16#0000_0000	
27	InputCycleCounterInput	Byte	%IB34	<input type="checkbox"/>	<input checked="" type="checkbox"/>	<input checked="" type="checkbox"/>	<input checked="" type="checkbox"/>	16#70	
28	AlignedInput	Byte	%IB35	<input type="checkbox"/>	<input checked="" type="checkbox"/>	<input checked="" type="checkbox"/>	<input checked="" type="checkbox"/>	16#00	
29	LatchValueInput	DWord	%ID36	<input type="checkbox"/>	<input checked="" type="checkbox"/>	<input checked="" type="checkbox"/>	<input checked="" type="checkbox"/>	16#0000_0000	
30	CycleInfoData1 Input	Word	%IW40	<input type="checkbox"/>	<input checked="" type="checkbox"/>	<input checked="" type="checkbox"/>	<input checked="" type="checkbox"/>	16#0000	
31	CycleInfoData2Input	Word	%IW42	<input type="checkbox"/>	<input checked="" type="checkbox"/>	<input checked="" type="checkbox"/>	<input checked="" type="checkbox"/>	16#0000	

Fig. 35: View TIA Portal, check correct assignment of process data and addresses

- Automatic readout of motor data via CoE parameters
 - In order to read the motor data directly from the electronic identification plate, the CoE parameters under "FB OCT Settings Ch.1" must all be set to "TRUE".
 - For this purpose, the device configuration must be opened under "Device & Network".
 - The EK9300 must then be double-clicked with the left mouse button.
 - As a result, the EK9300 can be seen with whole modules on the right side. To access the CoE parameters of the EL7201-0010, the Drive Motion Control module must be selected.
 - Afterwards, "Module parameters" must be selected under "Properties". The CoE parameter settings of the terminal should then be visible.

The screenshot shows the TIA Portal interface. At the top, a 'Device overview' table lists modules in a rack. Below this, the 'Drive motion control' module is selected, and its 'Module parameters' are displayed. The parameters are organized into sections: 'ECslavelnitValues', 'FB Settings Ch.1', and 'FB OCT Settings Ch.1'. The 'Enable auto config', 'Reconfig identical motor', and 'Reconfig non-identical motor' parameters in the 'FB OCT Settings Ch.1' section are highlighted in yellow.

Module	Rack	Slot	I address	Q addr...	Type	Article number
ek9300-1	0	0	0...3		EK9300 V2.34 (at l...	EK9300
EK9300 V2.34 (at least ...)	0	0 X1			ek9300	
EL7201-0010_1	0	1			EL7201-0010	EL7201-0010
ModuleAccessPoint	0	1 1			ModuleAccessPoint	
Drive motion control	0	1 2	4...45	0...21	Drive motion control	
	0	2				
	0	3				

Module parameters

ECslavelnitValues

DC Mode: FreeRun/SM-Synchron

FB Settings Ch.1

Invert feedback direction: False

Referenced: False

Device type: 3

Singleturn bits: 20

Multiturn bits: 12

Observer bandwidth: 500

Observer feed-forward: 0

Position offset: 0

FB OCT Settings Ch.1

Enable auto config: False

Reconfig identical motor: False

Reconfig non-identical motor: False

Fig. 36: TIA portal "Properties" - "Module parameters" view

- The parameters "Enable auto config", "Reconfig identical motor" and "Reconfig non-identical motor" must be set to TRUE. To write the values, the project must be compiled once and reloaded to the controller.
- An online access to the CoE parameters does not work. The values can only be changed offline.

5.4.2 EP9224 commissioning

This chapter describes the commissioning or the implementation of the EP9224-0037 into TwinCAT and TIA. Because the EP9224-0037 contains two EtherCAT slave controllers (ESC), two EP9224 must also be implemented during configuration. In the automation software these are represented once with the ending -0037 and once with -1037. For more information on the process image, refer to the documentation of [EP9224-0037](#).

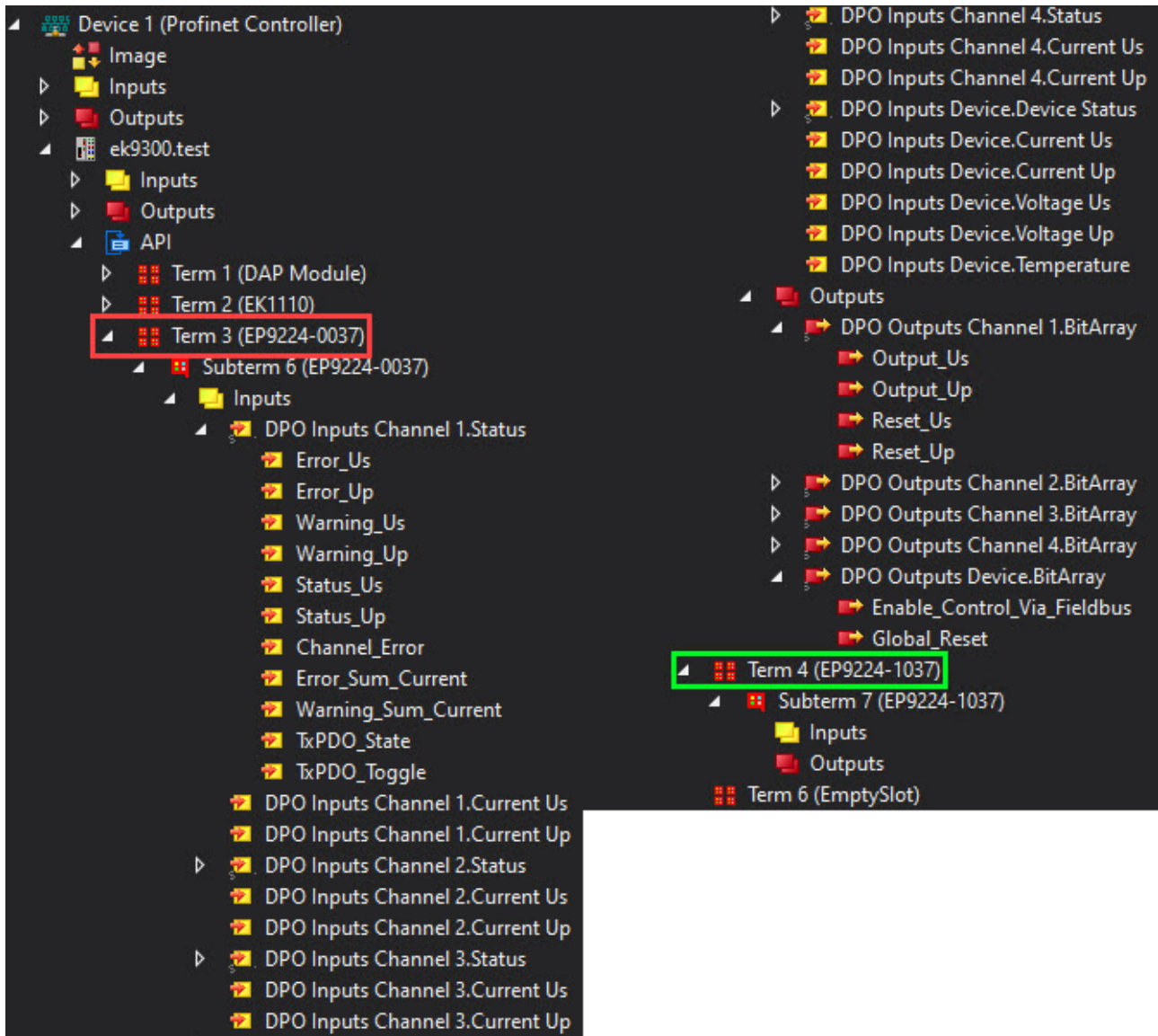

Fig. 37: Representation EP9224-0037 in TwinCAT

Geräteübersicht										
Modul	Baugr...	Steck...	E-Adresse	A-Adres...	Typ	Artikelnummer	Firmware	Kommentar	Zugriff	
ek9300	0	0	0..3		EK9300 V2.41 (min...	EK9300	V18.00		PLC_1	
EK9300 V2.41 (mind. FW...	0	0 X1			ek9300				PLC_1	
EK1110_1	0	1			EK1110	EK1110			PLC_1	
EP9224-0037_1	0	2	4..39	0..9	EP9224-0037	EP9224-0037			PLC_1	
EP9224-1037_1	0	3			EP9224-1037	EP9224-1037			PLC_1	
	0	4								
	0	5								

Fig. 38: Representation EP9224-0037 in TIA

Each IO module has four ports. Some of these ports are used internally as interfaces to each other, which are not accessible to the user. The others are available as interfaces to the connectors on the EP box. The following illustration shows the assignment of the connectors to the ports of the I/O modules.

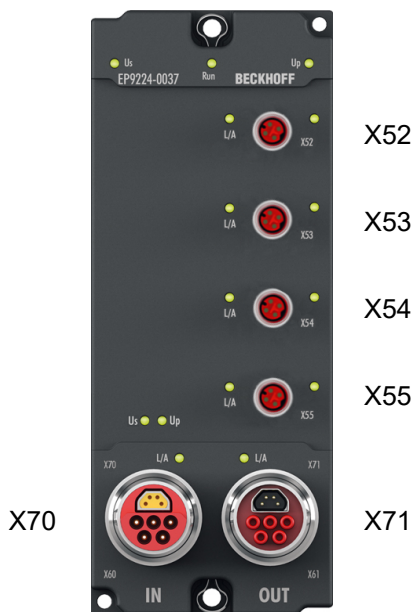

Fig. 39: Connector designations

Type	EP9224-0037	Automation software	
	Connector	IO module	Port
EtherCAT P output	X52	EP9224-1037	D
EtherCAT P output	X53		B
EtherCAT P output	X54		C
EtherCAT P output	X55	EP9224-0037	B
EtherCAT input	X70		A
EtherCAT output	X71		C

If the configuration is created offline, the user must know at which port or at which connector the EtherCAT devices are present at the EP9224 in which number and in which order.

The sequence of the EtherCAT devices to be configured on the EP9224 in the automation software starts with all EtherCAT devices on connector 52, then with all on connector 53, then with all on connector 54 and ends with the last EtherCAT device on connector 55. If there are no EtherCAT device(s) at a port, this port is omitted or skipped.

Sample configuration 1

Type	EP9224-0037	Automation software		EtherCAT devices		
	Connector	IO module	Port	1.	2.	n.
EtherCAT P output	X52	EP9224-1037	D	EPP3204	-	-
EtherCAT P output	X53		B	EPP3314	EPP2308	-
EtherCAT P output	X54		C	EPP1018	-	-
EtherCAT P output	X55	EP9224-0037	B	EPP3184	EPP1008	-
EtherCAT input	X70		A			
EtherCAT output	X71		C			

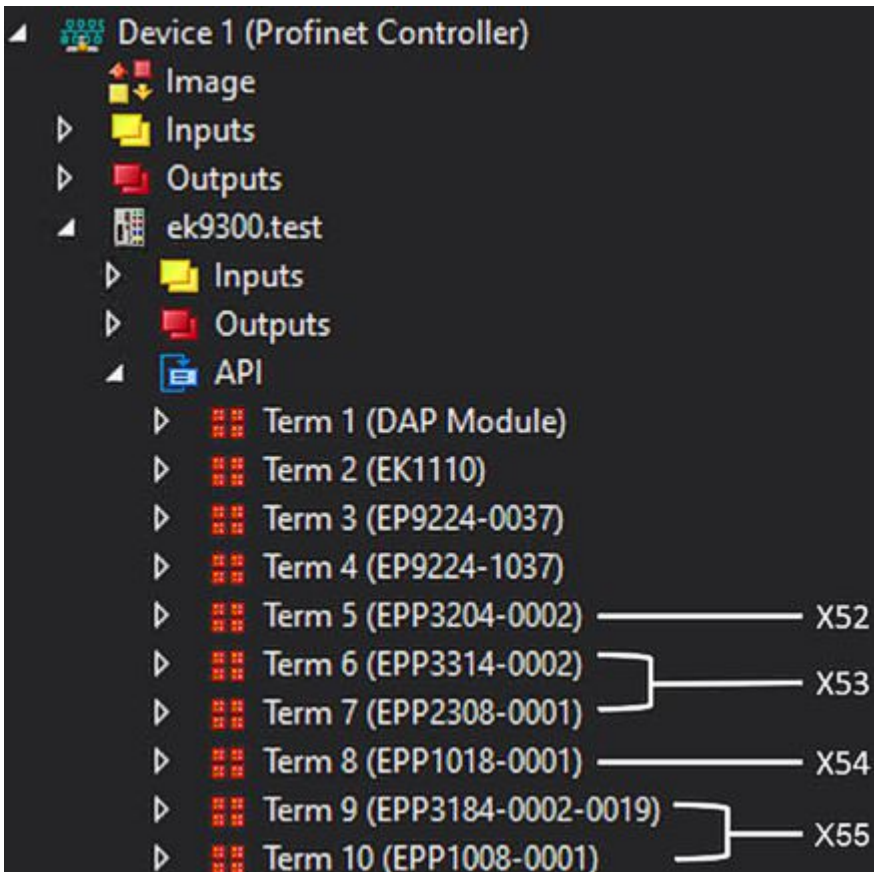

Fig. 40: Sample configuration 1 TwinCAT

Modul	Baugr...	Steck...	E-Adresse	A-Adres...	Typ	Artikelnummer	Firmware	Kommentar	Zugriff
ek9300	0	0	0...3		EK9300 V2.41 (min...)	EK9300	V18.00		PLC_1
EK9300 V2.41 (mind. FW...)	0	0 X1			ek9300				PLC_1
EK1110_1	0	1			EK1110	EK1110			PLC_1
EP9224-0037_1	0	2	4...39	0...9	EP9224-0037	EP9224-0037			PLC_1
EP9224-1037_1	0	3			EP9224-1037	EP9224-1037			PLC_1
EPP3204-0002_1	0	4	40...55		EPP3204-0002	EPP3204-0002		X52	PLC_1
EPP3314-0002_1	0	5	56...79		EPP3314-0002	EPP3314-0002		X53	PLC_1
EPP2308-0001_1	0	6	80	10	EPP2308-0001	EPP2308-0001			PLC_1
EPP1018-0001_1	0	7	81		EPP1018-0001	EPP1018-0001		X54	PLC_1
EPP3184-0002-0019_1	0	8	82...97		EPP3184-0002-0019	EPP3184-0002		X55	PLC_1
EPP1008-0001_1	0	9	98		EPP1008-0001	EPP1008-0001			PLC_1
	0	10							

Fig. 41: Sample configuration 1 TIA

Sample configuration 2

Type	EP9224-0037	Automation software		EtherCAT devices				
	Connector	IO module	Port	1.	2.	3.	4.	n.
EtherCAT P output	X52	EP9224-1037	D	EPP3204	EPP3314	EPP2308	EPP1018	-
EtherCAT P output	X53		B	-	-	-	-	-
EtherCAT P output	X54		C	-	-	-	-	-
EtherCAT P output	X55	EP9224-0037	B	EPP3184	EPP1008			
EtherCAT input	X70		A					
EtherCAT output	X71		C					

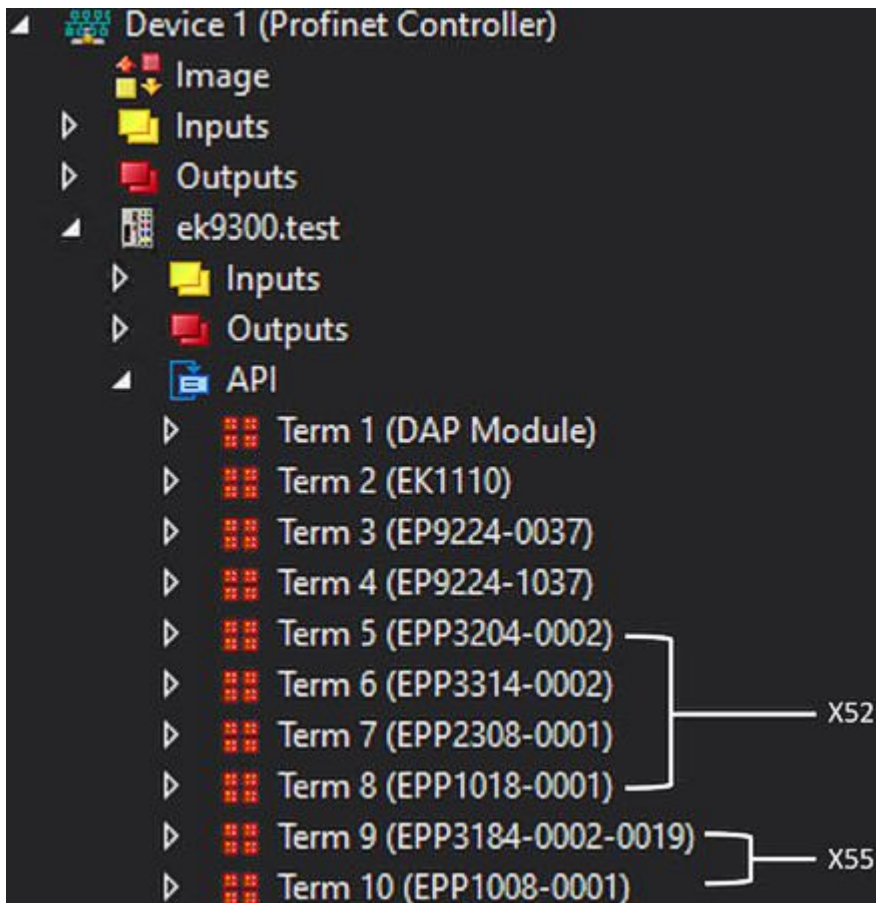

Fig. 42: Sample configuration 2 TwinCAT

Modul	Baugr...	Steck...	E-Adresse	A-Adres...	Typ	Artikelnummer	Firmware	Kommentar	Zugriff
ek9300	0	0	0...3		EK9300 V2.41 (min...	EK9300	V18.00		PLC_1
EK9300 V2.41 (mind. FW...	0	0 X1			ek9300				PLC_1
EK1110_1	0	1			EK1110	EK1110			PLC_1
EP9224-0037_1	0	2	4...39	0...9	EP9224-0037	EP9224-0037			PLC_1
EP9224-1037_1	0	3			EP9224-1037	EP9224-1037			PLC_1
EPP3204-0002_1	0	4	40...55		EPP3204-0002	EPP3204-0002			PLC_1
EPP3314-0002_1	0	5	56...79		EPP3314-0002	EPP3314-0002			PLC_1
EPP2308-0001_1	0	6	80	10	EPP2308-0001	EPP2308-0001			PLC_1
EPP1018-0001_1	0	7	81		EPP1018-0001	EPP1018-0001			PLC_1
EPP3184-0002-0019_1	0	8	82...97		EPP3184-0002-0019	EPP3184-0002			PLC_1
EPP1008-0001_1	0	9	98		EPP1008-0001	EPP1008-0001			PLC_1
	0	10							

Fig. 43: Sample configuration 2 TIA

5.4.3 EP9128 commissioning

The following chapter describes the commissioning and implementation of the EP9128-0021 in TwinCAT and TIA. Because the EP9128-0021 contains three EtherCAT slave controllers (ESC) to provide eight EtherCAT interfaces, three EP9128s must also be implemented during configuration. In the automation software project these are represented once each with the ending -0037, with -1037 and with -2037. For more information on the process image, refer to the documentation of EP9128-0021.

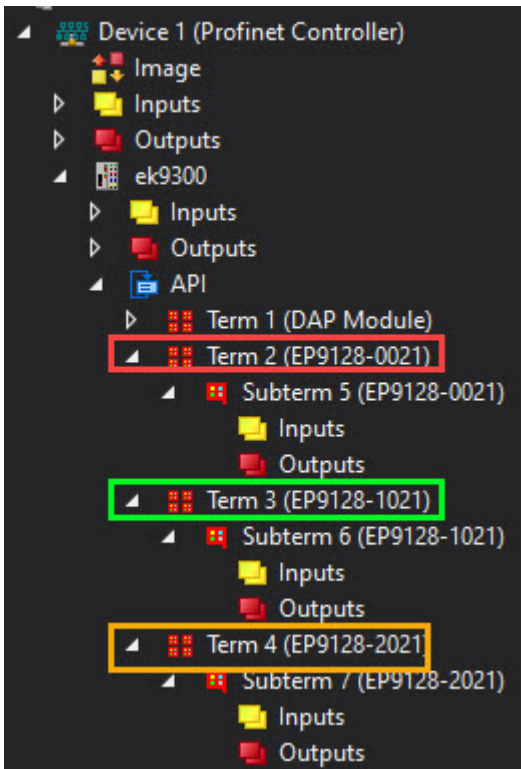

Fig. 44: Representation EP9128-0021 in TwinCAT

Modul	Baugr...	Steck...	E-Adresse	A-Adres...	Typ	Artikelnummer	Firmware	Kommentar	Zugriff
ek9300_1	0	0	99...102		EK9300 V2.41 (min...	EK9300	V18.00		PLC_1
EK9300 V2.41 (mind. FW...	0	0 X1			ek9300				PLC_1
EP9128-0021_1	0	1			EP9128-0021	EP9128-0021			PLC_1
EP9128-1021_1	0	2			EP9128-1021	EP9128-1021			PLC_1
EP9128-2021_1	0	3			EP9128-2021	EP9128-2021			PLC_1
	n	4							

Fig. 45: Representation EP9128-0021 in TIA

Each ESC or IO module has four ports. Some of these ports are used internally as interfaces to each other, which are not accessible to the user. The others are available as interfaces to the connectors on the EP box. The following illustration shows the assignment of the connectors to the ports of the I/O modules.

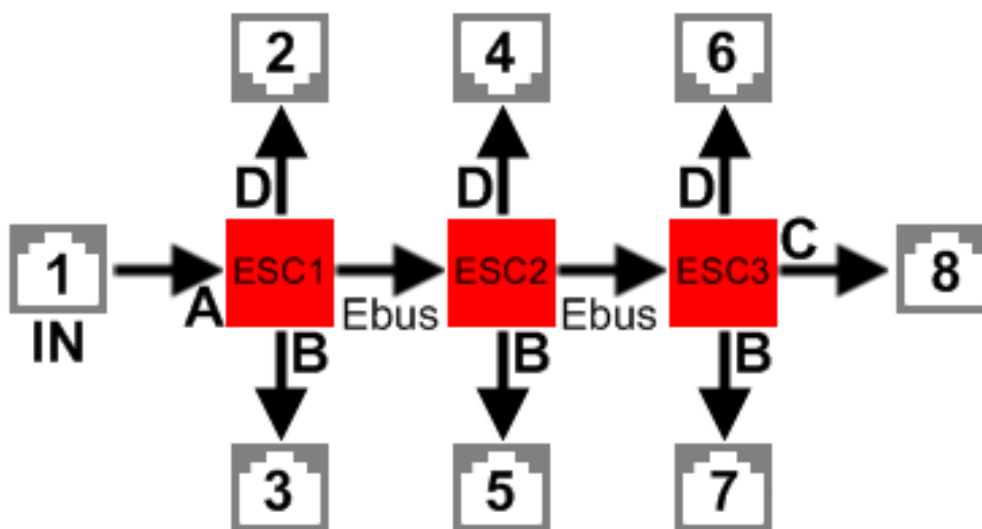

Fig. 46: EP9128 diagram

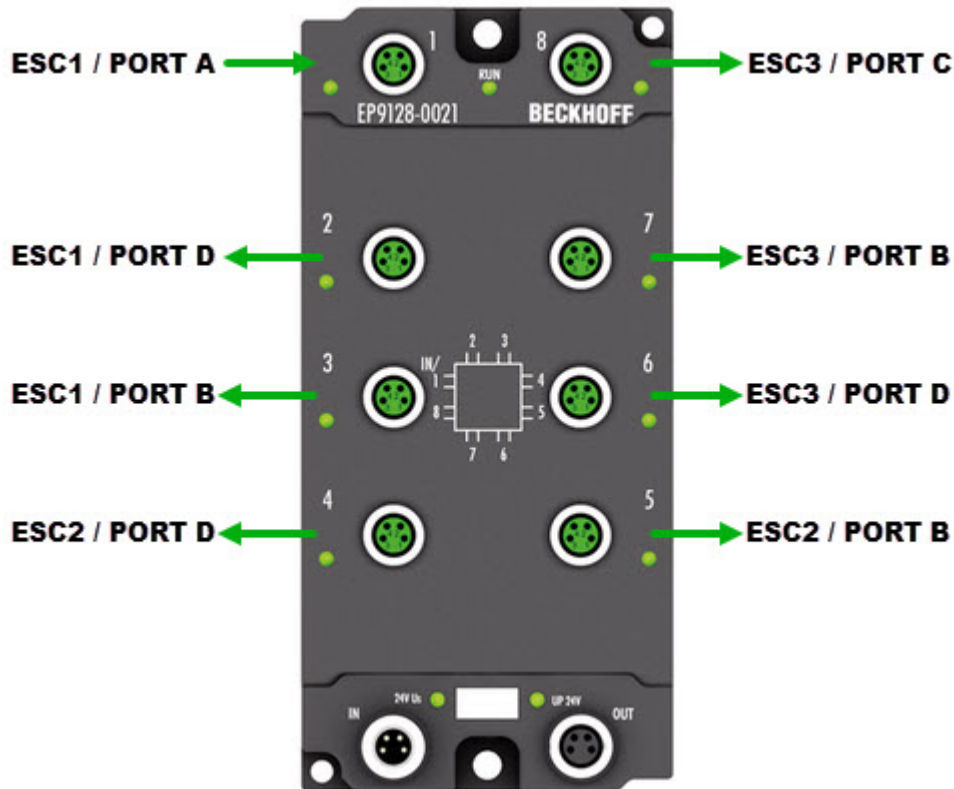

Fig. 47: Physical arrangement of the ports of the EP9128

Type	EP9128-0021		Automation software	
	Connector	IO module	Port	
EtherCAT input	1		ESC1 / port A	
EtherCAT output	2	EP9128-0021	ESC1 / port D	
EtherCAT output	3		ESC1 / port B	
EtherCAT output	4	EP9128-1021	ESC2 / port D	
EtherCAT output	5		ESC2 / port B	
EtherCAT output	6	EP9128-2021	ESC3 / port D	
EtherCAT output	7		ESC3 / port B	
EtherCAT output	8		ESC3 / port C	

If the configuration is created offline, the user must know at which port or at which connector the EtherCAT devices are present at the EP9128 in which number and in which order.

The sequence of the EtherCAT devices to be configured at the EP9128 starts with all EtherCAT devices at connector 2, then with all at connector 3, ..., 7 and ends with the last EtherCAT device at connector 8. If there are no EtherCAT device(s) at a port, this port is omitted or skipped.

Sample configuration

Type	EP9128-0021	Automation software		EtherCAT devices				
	Connector	IO module	Port	1.	2.	3.	4.	n.
EtherCAT input	1		ESC1 / port A	EK1110	-	-	-	-
EtherCAT output	2	EP9128-0021	ESC1 / port D	EK1100	EL3104	EL4034	-	-
EtherCAT output	3		ESC1 / port B	EK1100	EL3318	EL3318	-	-
EtherCAT output	4	EP9128-1021	ESC2 / port D	EP2338	EP3184	-	-	-
EtherCAT output	5		ESC2 / port B	EP3184	-	-	-	-
EtherCAT output	6	EP9128-2021	ESC3 / port D	EK1100	EL3318	EL3443	EL2535	-
EtherCAT output	7		ESC3 / port B	EK1100	EL3318	EL3061	EL6090	-
EtherCAT output	8		ESC3 / port C	EP4374	-	-	-	-

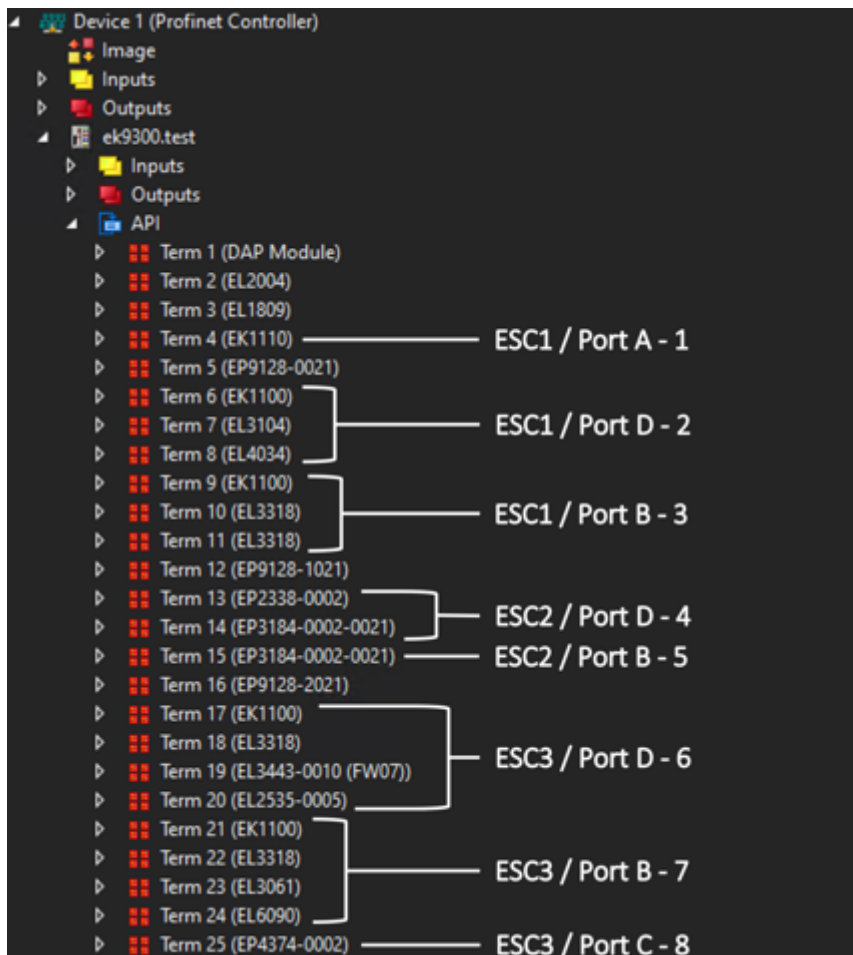

Fig. 48: Sample configuration TwinCAT

Modul	Baugr...	Steck...	E-Adresse	A-Adres...	Typ	Artikelnummer	Firmware	Kommentar	Zugriff
ek9300_1	0	0	99...102		EK9300 V2.41 (min...	EK9300	V18.00		PLC_1
EK9300 V2.41 (mind. FW...	0	0 X1			ek9300				PLC_1
EL2004_1	0	1		11	EL2004	EL2004			PLC_1
EL1809_1	0	2	103...104		EL1809	EL1809			PLC_1
EK1110_1	0	3			EK1110	EK1110		ESC1 / Port A - 1	PLC_1
EP9128-0021_1	0	4			EP9128-0021	EP9128-0021			PLC_1
EK1100_1	0	5			EK1100	EK1100			PLC_1
EL3104_1	0	6			EL3104	EL3104			PLC_1
ModuleAccessPoint	0	6.1			ModuleAccessPoint			ESC1 / Port D - 2	PLC_1
Standard	0	6.2	105...120		Standard				PLC_1
EL4034_1	0	7		12...19	EL4034	EL4034			PLC_1
EK1100_2	0	8			EK1100	EK1100			PLC_1
EL3318_1	0	9			EL3318	EL3318			PLC_1
ModuleAccessPoint	0	9.1			ModuleAccessPoint			ESC1 / Port B - 3	PLC_1
Standard	0	9.2	121...152		Standard				PLC_1
EL3318_2	0	10			EL3318	EL3318			PLC_1
ModuleAccessPoint	0	10.1			ModuleAccessPoint				PLC_1
Standard	0	10.2	153...184		Standard				PLC_1
EP9128-1021_1	0	11			EP9128-1021	EP9128-1021			PLC_1
EP2338-0002_1	0	12	185	20	EP2338-0002	EP2338-0002		ESC2 / Port D - 4	PLC_1
EP3184-0002-0021_1	0	13	186...201		EP3184-0002-0021	EP3184-0002		ESC2 / Port B - 5	PLC_1
EP3184-0002-0021_2	0	14	202...217		EP3184-0002-0021	EP3184-0002			PLC_1
EP9128-2021_1	0	15			EP9128-2021	EP9128-2021			PLC_1
EK1100_3	0	16			EK1100	EK1100			PLC_1
EL3318_3	0	17			EL3318	EL3318			PLC_1
ModuleAccessPoint	0	17.1			ModuleAccessPoint			ESC3 / Port D - 6	PLC_1
Standard	0	17.2	218...249		Standard				PLC_1
EL3443-0010 (FW01)_1	0	18			EL3443-0010 (FW0...	EL3443-0010			PLC_1
ModuleAccessPoint	0	18.1			ModuleAccessPoint				PLC_1
Default	0	18.2	250...409		Default				PLC_1
EL2535-0005_1	0	19			EL2535-0005	EL2535-0005			PLC_1
ModuleAccessPoint	0	19.1			ModuleAccessPoint				PLC_1
Standard	0	19.2	410...413	21...28	Standard				PLC_1
EK1100_4	0	20			EK1100	EK1100			PLC_1
EL3318_4	0	21			EL3318	EL3318			PLC_1
ModuleAccessPoint	0	21.1			ModuleAccessPoint			ESC3 / Port B - 7	PLC_1
Standard	0	21.2	414...445		Standard				PLC_1
EL3061_1	0	22			EL3061	EL3061			PLC_1
ModuleAccessPoint	0	22.1			ModuleAccessPoint				PLC_1
Standard	0	22.2	446...449		Standard				PLC_1
EL6090_1	0	23			EL6090	EL6090			PLC_1
ModuleAccessPoint	0	23.1			ModuleAccessPoint				PLC_1
LCD	0	23.2	450...451	29...32	LCD				PLC_1
EP4374-0002_1	0	24	452...459	33...36	EP4374-0002	EP4374-0002		ESC3 / Port C - 8	PLC_1
	0	25							

Fig. 49: Sample configuration TIA

5.5 From firmware Version 6

5.5.1 EK9300 - CoE data access over PROFINET

Description

CoE means **Can over EtherCAT**. It enables access to all parameters of an EtherCAT device. The CoE data model is based on the principles of CANopen and uses index and subindex for reading from and writing to parameters, if the corresponding access is enabled.

Further information can be found here: System Documentation

Task

Parameters of an EtherCAT device can generally be set and parameterized via the parameters of the GSDML file. However, in some applications it is necessary to change certain parameters at runtime or to carry out optimizations during operation.

Solution

The CoE data are sent via acyclic PROFINET services (PROFINET index 0x200F). The position of the EtherCAT device is specified via the slot number. The CoE data are then entered in the record data. During reading they consist of CoE index and CoE subindex, during writing they consist of CoE index, CoE subindex and the data to be sent.

Reading/writing sample

For reading, a WriteReq record must be sent first. This includes the CoE index and CoE subindex. After the WriteRsp a ReadReq has to be sent in order to retrieve the data, which are then contained in the ReadRsp.

Writing takes place in the same way, except that WriteReq includes the data, and ReadRsp serves as acknowledgement to indicate whether writing was successful.

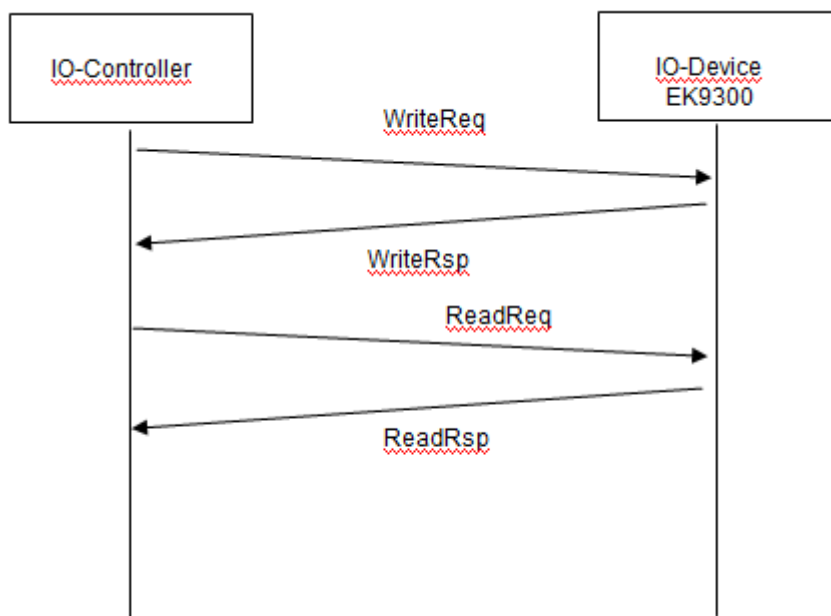

Fig. 50: CoE data access over PROFINET, read/write sample

Getting Started - Reading

PROFINET record data (write request)	Value	Meaning
Slot	Position of the EtherCAT device (1...255)	Slot number, position of the EtherCAT device
SubSlot	1	Sub-slot number, always "1"
Index	0x200F	PROFINET index number
Length	4	Length of the following data
Data	Bytes 1 and 2 SDO index Byte 3 CoE subindex Byte 4 "0" reserve	CoE data

Delay time, we recommend 100..250 ms until the read request is sent, which includes an acknowledgment of error-free writing.

PROFINET record data (read request)	Value	Meaning
Slot	Position of the EtherCAT device (1...255)	Slot number, position of the EtherCAT device
SubSlot	1	Sub-slot number, always "1"
Index	0x200F	PROFINET index number
Length	Write 4	Answer 4 bytes + x bytes
Data	Write Byte 1 "1" Byte 2 "0" Byte 3 "0" Byte 4 "0"	Answer Bytes 1..4 ADS error Bytes 4..x CoE data value
		CoE data

The response to the read request, i.e. the read response, includes the data. The first 4 bytes contain the error code. This is "0" if the response is error-free. The error code is an ADS error code. Further information can be found under the following link.

http://infosys.beckhoff.com/content/1031/tcsample/html/ads_returncodes.htm

 Wireshark sample for reading (<https://infosys.beckhoff.com/content/1033/ek9300/Resources/2609011595/.zip>)

Getting Started - Writing

PROFINET record data (write request)	Value	Meaning
Slot	Position of the EtherCAT device (1...255)	Slot number, position of the EtherCAT device
SubSlot	1	Sub-slot number, always "1"
Index	0x200F	PROFINET index number
Length	4	Length of the following data
Data	Bytes 1..2 SDO index Byte 3 SDO subindex Byte 4 "1" constant Bytes 5..8 length as DWORD Bytes 9..x CoE data value	CoE data

Delay time, we recommend 250..500 ms until the read request is sent, which includes an acknowledgment of error-free writing.

PROFINET record data (read request)	Value		Meaning
Slot	Position of the EtherCAT device (1...255)		Slot number, position of the EtherCAT device
SubSlot	1		Sub-slot number, always "1"
Index	0x200F		PROFINET index number
Length	Write 0	Answer 4	Length of the following data
Data	Write -	Write ADS error code	CoE data

The response to the read request, i.e. the read response, includes confirmation that writing was successful. The first 4 bytes contain the error code; "0" indicates error-free response. The error code is an ADS error code. Further information can be found under the following link ([system documentation](#)).

 Wireshark sample for writing (<https://infosys.beckhoff.com/content/1033/ek9300/Resources/2609013771/.zip>)

● Observe data format

i During reading and writing, observe the data size and the format of the corresponding SDO parameters. We recommend reading the SDO data first, then interpret them and use the read data format also for writing the CoE data (perhaps swap High/Low BYTE/WORD).

● Start-up parameters overwrite CoE data

i CoE data are typically not stored in the EtherCAT device. Ensure that start-up parameters (GSDML) overwrite the CoE data during startup of the EK9300.

5.5.2 EK9300 - multi-configuration mode

Description

Multi-configuration mode enables users to operate different hardware, e.g. a EK9300 with varying EtherCAT Terminals, with the same project configuration.

This description uses EtherCAT Terminals (ELxxx) in the examples. The same principle applies to EtherCAT Box modules (EPxxx).

Task

The machine manufacturer has a machine, which is to be sold with different options. The options are usually additional signals to be processed and logged, for which additional terminals are required.

For all these options the project configuration should be retained and only be varied via the software. The actual machine options are included in the parameterization.

Solution

The multi-configuration mode is used to configure the maximum number of options in the project configuration. If the machine has less than the maximum number of options, EtherCAT Terminals can be omitted, since these signals are not required. Although unused EtherCAT Terminals are included in the maximum project configuration, they can be disabled by the controller, so that the hardware and the parameterized configuration match again. As soon as this is done, the EK9300 switches to normal data exchange.

Advantage

Less effort for creating and maintaining projects, since the same project configuration can be used for different hardware.

Sample

The standard machine configuration, without options, consists of:

- 1 x EK9300
- 2 x EL2004
- 2 x EL1004
- 1 x EL5051

The following options can be added:

- With energy monitoring for logging the energy consumption: additionally an EL3403
- With automatic adjustable axis: additionally an EL7047
- With temperature measurement: additionally an EL3314

The maximum configuration (with optional terminals shown in italics) then looks as follows:

- 1 x EK9300
- 2 x EL2004
- 2 x EL1004
- 1 x EL5051
- 1 x EL3314
- 1 x EL7047
- 1 x EL3403

It is this maximum configuration that is reflected in the hardware configuration.

If the machine is ordered without options, the terminals EL3314, EL7047 and EL3403 have to be disabled in the project configuration. The EK9300 is notified of the record data (acyclic communication) to indicate which terminals are no longer required. The terminals are identified via their position.

Without options, two EL2004 are present (at position 1 and 2), two EL1004 (at position 3 and 4) and one EL5051 (at position 5). The terminals at positions 6, 7 and 8 (optional terminals) must be disabled.

If the machine is ordered with the option "automatic adjustable axis", only terminals 6 and 8 have to be disabled.

Position of optional terminals

I Optional terminals can be connected at any position and may be disabled. They do not necessarily have to be located at the end, as shown in the example.

First steps

In order to enable the EK9300 to operate in multi-configuration mode, MultiConfigurationMode must be set to "TRUE" in the DAP (device access point).

There are two possible setting options.

Option 1

This is perhaps a version for testing, since the hardware configuration must be adjusted, which should preferably be avoided.

In the DAP there is a MultiConfigurationMode setting with the slots. Here you can disable EtherCAT Terminals, which are configured but not present.

For some PROFINET controllers this must happen on startup, while other PROFINET controllers enable it to occur at runtime, which simplifies testing significantly. Disabling/enabling of terminals at runtime is a feature of the PROFINET controller and may or may not be possible in practice, depending on the manufacturer of the PROFINET controller.

Option 2

The configuration is sent by the PLC via the record data. Here too, the manufacturers offer different options. Contact the manufacturer of your PROFINET controller, if you have any queries. A requirement for option 2 is that your PROFINET controller allows and supports access to the record data.

PROFINET record data (write request)	Value	Meaning
Slot*	0	Slot number, always "0"
SubSlot*	1	Sub-slot number, always "1"
Index	0#2010	PROFINET index number
Length	variable	Length of the following data
Data	Each Bus Terminal requires 2 bits: 00 _{bin} terminal present 10 _{bin} terminal not present	Enabling/disabling of the EtherCAT devices

* For some PROFINET controllers these data are automatically taken from the GSDML and do not have to be configured.

Procedure

Once the station has been configured, the following steps are required.

If the machine is ordered with the maximum configuration (with all options), generally no action is required, since the hardware matches the project configuration.

If one of the options is not included, then hardware and project planning differ. The PROFINET coupler indicates this via the message "Module difference".

Now disable the terminals, which are not present. When this is done, the message "Module Difference" is removed from the coupler. If the message "Module Difference" remains, you may have the wrong slot or too few slots disabled.

● **No subslots**

i Subslots are not counted and cannot be used for the multi-configuration mode. Only slots can be used, irrespective of a module using subslots or not.

● **No Shared Device**

i The Shared Device feature cannot be used when the multi-configuration mode is used.

● **No pack or (*) terminals**

i Pack or (*) terminals cannot be used in multi-configuration mode.

5.5.3 EK9300 - IO-LINK

Description

The EK9300 (from firmware 6) supports the IO-Link master EL6224 (EtherCAT Terminal) and EP6224 (EtherCAT Box). The GSDML file (from version GSDML-V2.32-beckhoff-EK9300-20160408.xml) includes this IO-Link master. Each IO-Link device is addressed as a submodule and must be configured via the GSDML file.

● **Use with the EL6224/EJ6224**

i If the EL6224/EJ6224 IO-Link terminal is used, the process data 83 bytes input or 83 bytes output must not be exceeded. This means that the process data of all 4 IO-Link channels added together must not exceed this value. It is therefore not possible to use 32-byte modules 4 times, since these are larger than 83 bytes with 4 x 32 bytes.

This does not apply to the Beckhoff EP or EPP boxes with IO-Link.

Task

Connection of an IO-Link sensor to an EK9300.

Configuration of the process data

Each IO-Link device is added as a submodule. For each IO-Link device a submodule is used. The process data size of the submodule must always be equal to or greater than that of the IO-Link device and must not be less.

If not all IO-Link channels are used, empty channels should be entered. For example, if sensors are only connected to inputs 2 and 4 of the IO-Link master, while inputs 1 and 3 are unused, first enter an empty channel as submodule, then the sensor at input 2, then another empty channel and finally the sensor at input 4. The first submodule used by the IO-Link master is a diagnostics module. This is always present when the EL6224/EP6224 is added. This submodule contains the status of all connected IO-Link devices. If the sensor is in IO-Link data exchange, this is indicated via the corresponding byte (0x03 means all OK).

Information on the status byte:

0x_0 = Port disabled
0x_1 = Port in std dig in
0x_2 = Port in std dig out
0x_3 = Port in communication OP
0x_4 = Port in communication COMSTOP / dig in Bit (only in std. IO Mode)
0x_8 = Process Data Invalid Bit
0x1_ = Watchdog detected
0x2_ = internal Error
0x3_ = invalid Device ID
0x4_ = invalid Vendor ID
0x5_ = invalid IO-Link Version
0x6_ = invalid Frame Capability
0x7_ = invalid Cycle Time
0x8_ = invalid PD in length
0x9_ = invalid PD out length
0xA_ = no Device detected
0xB_ = error PreOP/Data storage

Regarding the process data size of an IO-Link device, please refer to the documentation or consult the manufacturer.

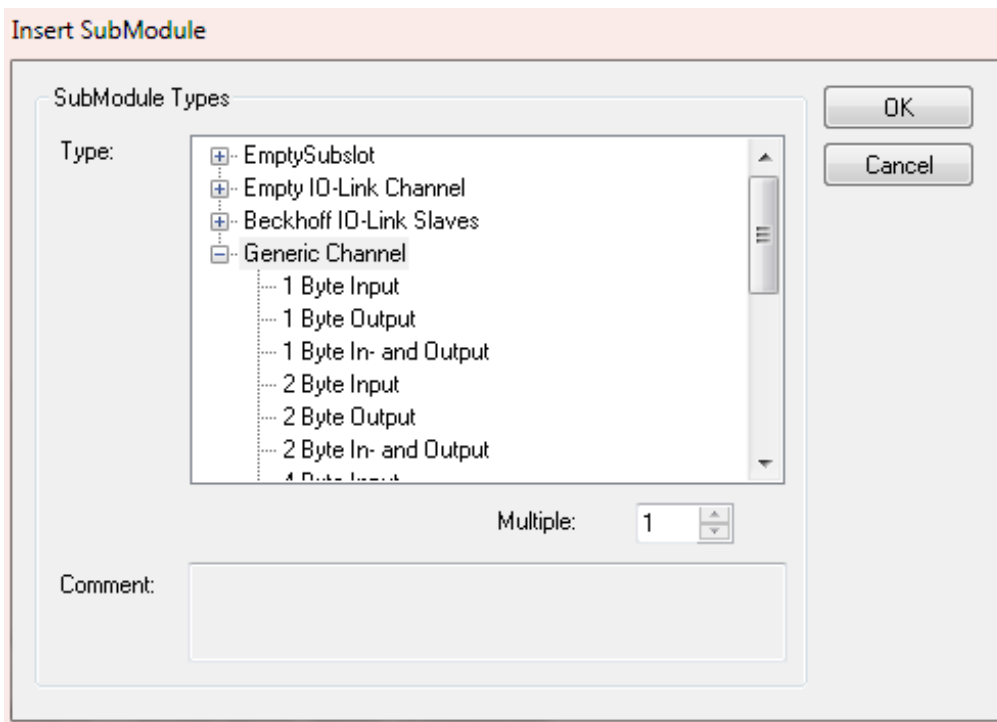

Fig. 51: Inserting a "generic channel" (in the case of IO-Link devices from other manufacturers)

IO-Link devices from Beckhoff are automatically added with the required parameters. For devices from other manufacturers please use a generic channel and select the process data size.

Configuration of the IO-Link device

The minimum settings required for operating an IO-Link device are:

IO-Link version: Generally 1.1; enter 11

Frame capability: Generally 1

Min. cycle time: Generally 2.3 ms, i.e. 23

Process data in / Out length: Variable (number in bits), for a size of 2 bytes input enter 16 for "Process data in length".

If the IO-Link slave has more than 16 bits, the high bit is set (BIT 7 TRUE), then the data length is specified in bytes + 1, example 4 bytes of process data, a 0x83 (131 dec) must be specified, 0x8x then stands for counting bytes and the length is then 3 (=4 bytes). A maximum of 32 bytes is then possible here.

Master control: set to IO-Link

All other settings are optional.

General		Parameterize Module			
Channel settings		Name	R/W	Offline Value	Online Value
Index 0x3000		Device ID	R/W	0	0
		Vendor ID	R/W	0	0
		IO-Link Revision	R/W	11	11
		Frame capability	R/W	1	1
		Min cycle time	R/W	23	23
		Offset time	R/W	0	0
		Process data in length	R/W	16	16
		Process data out length	R/W	0	0
		Compatible ID	R/W	0	0
		Reserved	R/W	0	0
		Master Control	R/W	IO-Link	IO-Link
		Enable Datastorage	R/W	disabled	disabled
		Enable Datastorage Upload	R/W	disabled	disabled
		Error Reaction	R/W	Freeze	Freeze

Fig. 52: Configuration of the IO-Link device

Reading/writing of parameters

Each IO-Link device has parameters that can be read or written. The EK9300 supports this function from firmware 10. The EK9300 has implemented the IO-Link profile from this firmware.

Many manufacturers of PROFINET controllers support the IO-Link profile with corresponding devices that you can use. For more information, please contact your controller manufacturer.

IO-Link devices for PROFINET

i Beckhoff currently does not offer IO-Link devices for PROFINET, since we assume that if Beckhoff products are used, Beckhoff IO-Link via EtherCAT will also be used.

For EtherCAT Beckhoff offers ADS blocks, or also IO-Link dialogs for simple commissioning, as well as working with and using the IO-Link description files.

Here is an example from the Siemens TIA world:

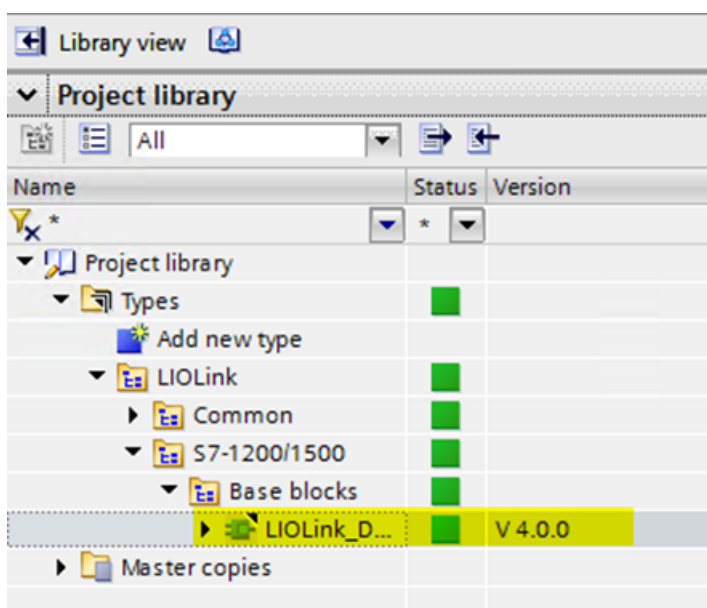

Fig. 53: Inserting IO-Link devices in the TwinCAT tree

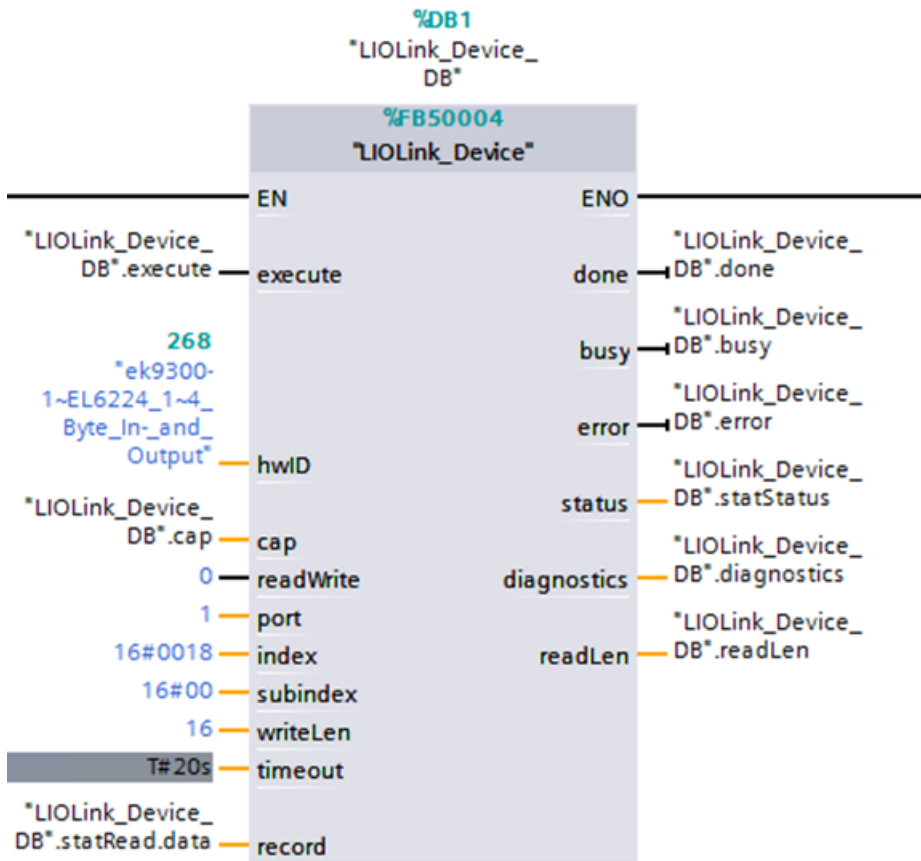

Fig. 54: Structure of an IO-Link device

5.6 From firmware version 8

In order to be able to use the updated firmware version 8, you have to use the corresponding GSDM device description, from version GSDML-V2.32-beckhoff-EK9300-20170216.XML.

Add the corresponding GSDML DAP for the firmware (FW8.0).

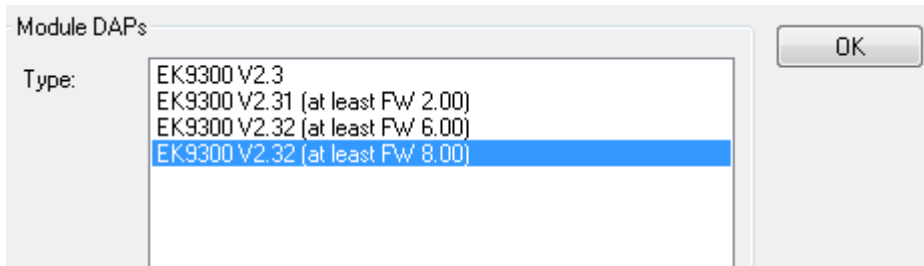

Fig. 55: Adding the GSDML DAP for firmware FW8.0

5.6.1 EBus Error Behaviour

The parameter *EBus error behavior* is new in firmware version 8.

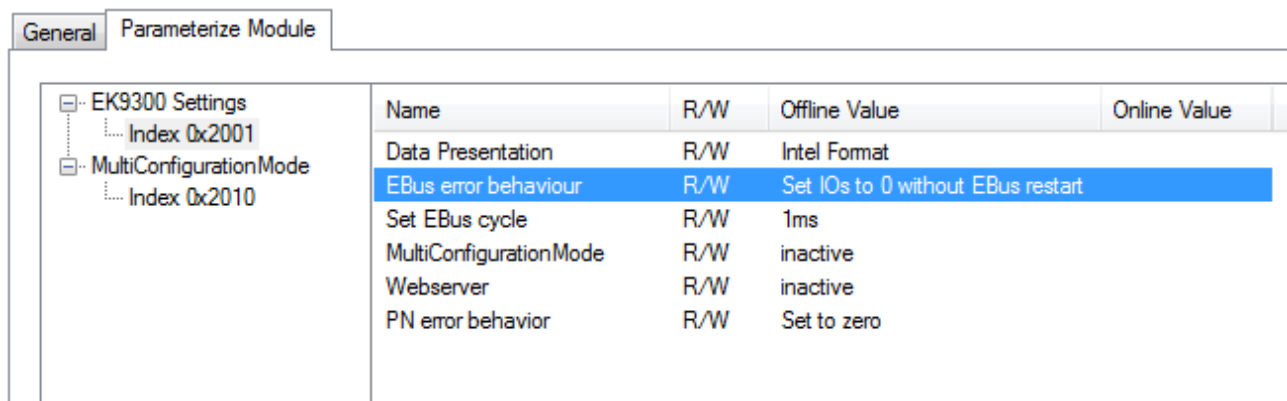

Fig. 56: The parameter EBus error behavior

This parameter is used to set the response to an E-bus error. The following options are available:

Legacy	Output data is still written, input data is frozen and therefore no longer current.
Set IOs to 0	Output data is written to zero; input data is written to zero; when the E-bus is error-free, it automatically starts the data exchange.
Set IOs to 0 without EBus restart (Default setting)	Output data is written to zero; input data is written to zero; when the E-bus is error-free, it can be activated again via the record data (see below).

Activating the E-bus after an E-bus error

In the DAP, information about the E-bus is provided via the status DWord. When an error occurs in the E-bus, the bit *EcFrameError* is set (in the high word bit offset x.2). Once the error has been rectified and the coupler is ready to restart the E-bus, the bit *EcFrameError* is reset and the flag *NeedEBusRese* is set in the high word bit offset x.4.

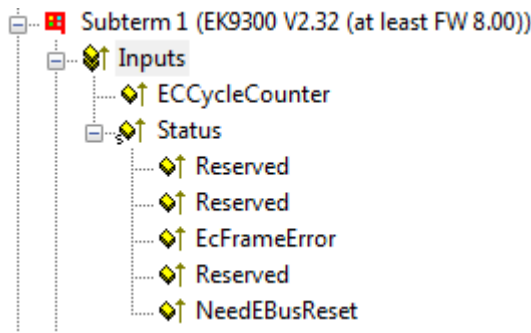

Fig. 57: Flag NeedEBusReset

The reset is issued via record data and is structured as follows.

PROFINET record data (write request)	Value	Meaning
Slot	0	Slot number
SubSlot	1	Sub slot number
Index	0x2013	Index Reset
Lenght	2	Data length
Data	0x1234	Value

Once the reset has been issued, the bit *NeedEBusReset* is reset.

5.6.2 Activating the web page

The web page can be activated via the parameter data of the DAP. Set the parameter *Web server* to *active* and connect the EK9300 to your PROFINET controller. Once the connection has been established and the IP address has been received, the web page of the EK9300 can be accessed.

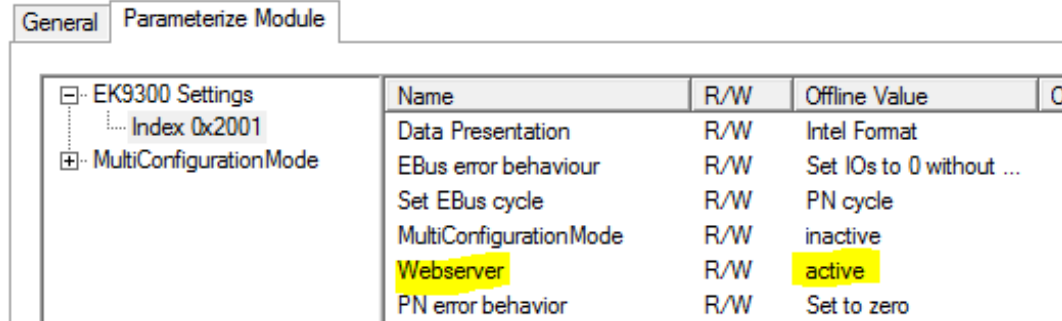

Fig. 58: Setting the parameter Web server to active

We recommend to use this web page only for diagnostic purposes and to avoid implementing settings there, since this should generally be done through the PROFINET controller.

The web page can be reached by calling the IP address of the EK9300 with the parameter *Config*
 Example: 192.168.1.10 /Config

User name: guest
 Password: 1

In order to access the web page, the following requirements must be met:

- The web page must have been activated via the parameter data of the EK9300.
- The PROFINET controller must have been in data exchange with the EK9300 at least once, so that the parameters and the IP address on the EK9300 are set.
 The coupler must not be de-energized afterwards, otherwise settings/parameters are not accepted and events in the log of the WebServer are lost.
- The PC with the web browser must be in the same IP segment as the EK9300. Use the PING command from the PC to check whether the PC can reach the EK9300. If this is the case, you can call up the web page of the EK9300.

If the PING command fails, check the following:

- Was the web page enabled?
 - Was the communication between the PROFINET controller and the EK9300 successful?
 - Is the IP address of the PC correct?
-



Browser recommendation

We recommend Chrome or Firefox for displaying the web page.

6 Error handling and diagnosis

6.1 Diagnostic LEDs

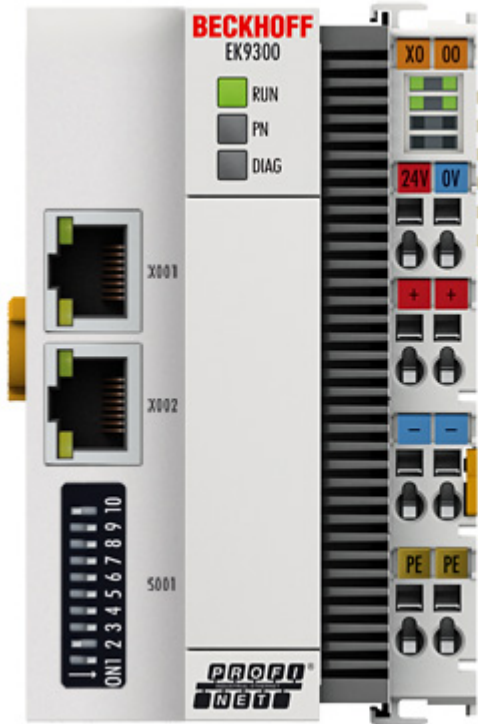

Fig. 59: EK9300 LEDs

Ethernet interface X001

Interface X001/X002	Ethernet (CX8090)	Meaning
LED green	on	Link available/activity
LED yellow	is not used	-

LED coupler

Labelling	Meaning	Color	Meaning
RUN	Indicates the status of the coupler	red	May only light up during the start-up phase
		Green	Coupler is ready
		Blue (If red DIP switch 1 is set to on when starting the coupler)	The internal Flash can be reached via USB (firmware update)

LED PN	PROFINET status		Meaning
	green	red	
Power On	off	200 ms flashing	Start-up phase
No name	200 ms flashing	off	no Profinet name
No IP	1 s off, 200 ms on	off	No IP address
Run	on	off	OK

LED DIAG	PROFINET diagnosis		Meaning
	green	red	
Flashing, PN controller identification	500 ms	500 ms	The PN controller is transmitting an identification signal
No AR established	off	200 ms flashing	The establishment of a connection with the controller has not been completed
Device is in IO exchange Error display of Outputs CR is set to module differences	1 s off, 200 ms on	off	Problem with establishment of a connection or nominal and actual configuration differ
Device is in IO exchange but provider is in stop	200 ms	off	Coupler is in data exchange, but PLC is in stop
Device is in IO exchange	on	off	OK

LED power supply terminal

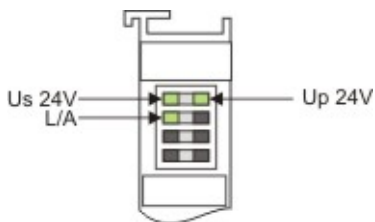

Fig. 60: LED power supply terminal

Operation with E-bus terminals

Display LED	Description	Meaning
1 Us 24 V (top left, 1 st row)	CX8000 supply voltage	on: connected to: 24 V
2 Up 24 V (top right, 1 st row)	Power contacts supply voltage	on: connected to: 24 V
3 L/A (left center, 2 nd row)	EtherCAT LED	flashing green: EtherCAT communication active on: E-bus connected / no data traffic off: E-bus not connected

7 Appendix

7.1 FAQ

The following points provide answers to frequently asked questions and notes on settings in the configuration of the PROFINET system. If they are not observed, this can lead to undesired behavior. Here you will find approaches to diagnosis.

7.1.1 Device description file (GSDML) / DAP (DeviceAccessPoint)

Device description file (GSDML) / DAP (DeviceAccessPoint)

- Is the GSDML available on the system?
- Do the versions of both systems match?
 - It is recommended to use the same GSDML/DAP versions on both systems.
 - Is the latest version used?
- Is the GSDML in the correct path?
 - TwinCAT 2: TwinCAT2: C:\TwinCAT\Io\ProfiNet
 - TwinCAT 3: C:\TwinCAT\3.1\Config\Io\Profinet
- Is the correct GSDML used?
 - Version
 - It may be necessary to contact the vendor/manufacturer or search for the appropriate GSDML on the vendor's website.
- Where can I find GSDML files?
 - From Beckhoff products the GSDML files are usually delivered with the installation of TwinCAT.
 - On the [Beckhoff website](#), use the "Download Finder" and its filter options for this purpose

The screenshot shows the Beckhoff website's 'Download finder' page. The page is titled 'Download finder' and contains the following content:

- Our download finder contains all the files that we offer you for downloading: from our application reports and technical documents to the configuration files.
- The downloads are available in various formats.
- On request, we will be glad to send you our catalogs and brochures in printed form. Please use our [online order form](#) to specify your requirements.

The page features four main categories of downloadable files, each with a representative image and a 'Learn more' link:

- Application notes**: The Application Notes contain application examples for our products. [Learn more →](#)
- Data sheets**: We offer you PDF data sheets for our accessory products such as cables, lines, connectors, etc. [Learn more →](#)
- Information media**: Beckhoff provides a great deal of information media, which can be downloaded as PDF files. [Learn more →](#)
- Configuration files**: Here you will find the appropriate configuration files for various bus systems in different file formats, such as EDS or GSD files. [Learn more →](#)

Fig. 61: Website Download finder

The screenshot displays the Beckhoff website's 'Download finder' interface. At the top, there is a navigation bar with the Beckhoff logo and 'New Automation Technology' text. Below this, a search bar and navigation links are visible. The main content area is titled 'Download finder' and includes a search input field. The current selection is 'Media: Configuration files' and 'File type: GSDML'. A dropdown menu is open, showing 'Items per page' options: 5 items, 10 items, 25 items (selected), and 50 items. The main content area lists several product entries, each with a 'Downloads' button. The sidebar on the right shows category filters: 'Information media' (174), 'Configuration files' (227), 'Macros' (3), 'Environmental product compliance' (12), 'Software and tools' (165), 'Technical documentations' (2853), 'Technical drawings' (11446), and 'Certificates, approvals' (136). Under the 'File type' filter, 'GSDML' (12) is selected.

Fig. 62: Website Download finder (filtered)

- For products from other suppliers/manufacturers, the supplier must be contacted or the GSDML files can be downloaded from the website.

7.1.2 Task configuration

Task configuration

- Has a free-running task been created?
 - Or a "special sync task" used?
- Cycle time to base 2?
 - 1ms, 2ms, 4ms, 8ms,

The screenshot shows a software configuration window with several tabs: General, Adapter, PROFINET, Sync Task, Diag History, and Diagnosis. The 'Sync Task' tab is active. Under the 'Settings' section, the 'Special Sync Task' radio button is selected. Below it, a dropdown menu shows 'Task_PROFINET' and a 'Create new I/O Task' button. The 'Sync Task' section contains the following fields: 'Name' is 'Task_PROFINET', 'Cycle ticks' is '1' (with a multiplier of '1.000 ms'), and 'Priority' is '1'. There is also an unchecked checkbox for 'Adjustable by Protocol'.

Fig. 63: Setting "Special Sync Task"

- Further notes in chapter [Sync Task](#)

7.1.3 EL663x-00x0 EtherCAT Terminals

EL663x-00x0 EtherCAT Terminals

- Was the correct terminal used?
 - EL663x-0000 cannot be used as device
 - EL6631-0010 cannot be used as controller

EL663x-00x0 EtherCAT Terminals

- Was the correct terminal used?
 - EL663x-0000 cannot be used as device
 - EL6631-0010 cannot be used as controller

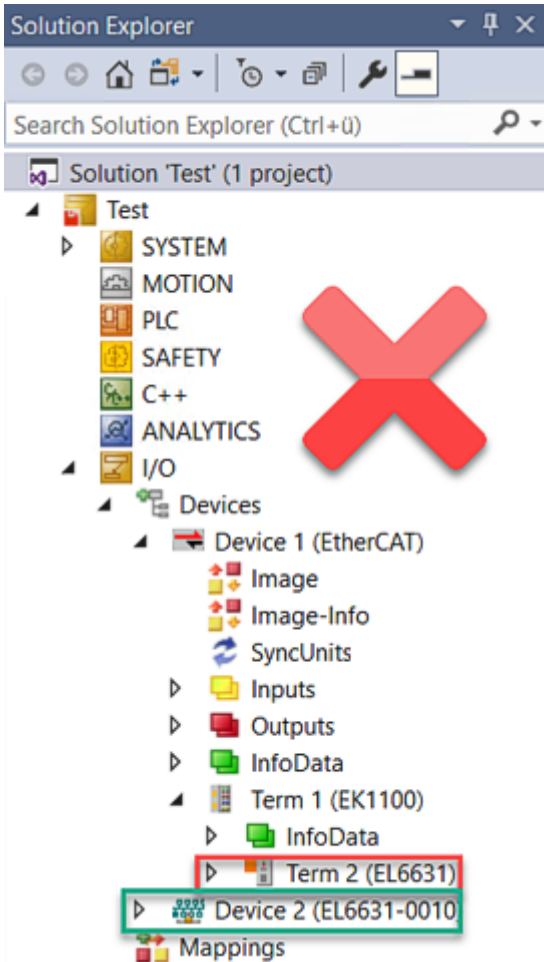

Fig. 64: Wrong configuration

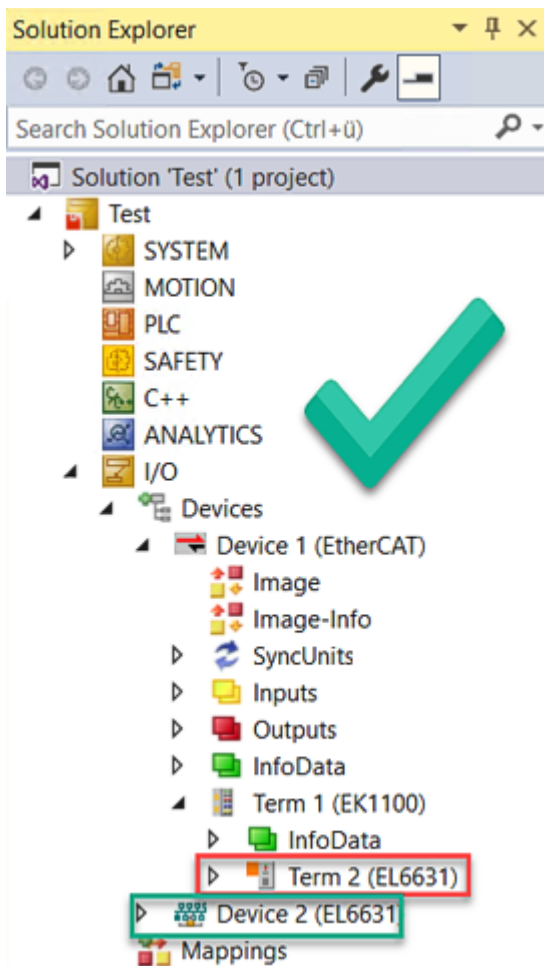

Fig. 65: Correct configuration

- EtherCAT diagnostics
 - EtherCAT state = Operational (OP)
 - WcState = 0 (Data valid)
- EtherCAT diagnostics
 - EtherCAT state = Operational (OP)
 - WcState = 0 (Data valid)

7.1.4 BoxStates of the PROFINET devices

BoxStates of the PROFINET devices

- Communication established?
 - See [Box States](#)

7.1.5 EK9300 – FAQ

How can I leave the outputs in the current state in case of a PROFINET error?
For this, two settings need to be made in the GSDML – i.e. in the configurator. First of all, "Activate PN reset value" in the DAP must be set to ON. The value "Frozen" must then be selected in the corresponding digital output terminal. The setting can only be made for a complete terminal; i.e. in the case of an EL2004 all 4 channels are then in the frozen state.
I would like to change the mapping of an EtherCAT terminal. Why doesn't it offer me this option?
The standard mapping is always appended by default. If other mappings are possible you must first delete the standard mapping from your configurator and then insert the new submodule.
The 2 or 4-channel digital output terminals are to be mapped to one byte. How do I do that?
The GSDML file contains the so-called "PACK" terminals. Without asterisk means that a byte is created, with asterisk that the byte is filled. Pack terminals must always be situated one behind the other (physically) and the byte may not be exceeded.
Where can I get the GSDML file?
The GSDML file can be downloaded here .
Where can I find the MAC address of the coupler?
The MAC address is printed on the label on the side of the coupler.
What is the USB interface for and what can I do with it?
The USB interface is to be used at present only for firmware updates.
What is the purpose of the DIP switch behind the flap?
The DIP switch is necessary, for example, for the use of the firmware update (see chapter entitled "DIP switch").
Can I also connect K-bus terminals?
No, only EtherCAT terminals or EtherCAT boxes can be connected. You can use the BK9053 or BK9103 for K-bus terminals. The use of EtherCAT couplers for K-bus such as the BK1120 or BK1250 is not possible.
I have an EtherCAT slave from a third-party vendor, can I also connect it?
No, devices from other vendors can only be used with a CX (see CX8093 or similar products).
I would like to operate the drive terminals/drives on the EK9300. Is that possible?
No, use a CX with a suitable performance for this – CX9020 or higher.
I would like to operate TwinSAFE terminals on the EK9300. Is that possible?
No, the TwinSAFE terminals require a TwinCAT system for configuration; use the CX8093 for this.
How can I tell whether there is an EtherCAT error?
There is a Status word in the DAP of the coupler. A bit is set here if an error occurs in EtherCAT (EK9300 configuration [► 48]). Further information about the error can be obtained through the PROFINET alarms.

7.2 Update Bus Coupler image

i Loss of data

The data in the internal flash memory are deleted.
Save your data before you update the Bus Coupler image.

The Bus Coupler image can be updated via the USB interface. To this end the Bus Coupler is connected with a host PC via a USB cable. Windows then shows the Bus Coupler as a removable data storage device, and the files can be copied.





The Bus Coupler should only be updated after consultation with the Beckhoff Service. The Beckhoff Service will provide all the required files.

Requirements

- First, check whether the Bus Coupler supports the image.
- The Bus Coupler is connected with the host PC via a USB cable.

Update the image as follows:

1. Switch off the Bus Coupler.
2. Switch the red 2-pin **DIP switch 1** to “on” (to the right) and switch on the Bus Coupler. The Bus Coupler appears as a removable data storage device on the host PC.
3. Select and delete all files. Do not format.

 BkpcDiag	01.01.2006 11:00	Dateiordner	
 Documents and Settings	01.01.2006 11:00	Dateiordner	
 TwinCAT	01.01.2006 11:00	Dateiordner	
 NK.bin	22.05.2017 15:03	BIN-Datei	12.697 KB

4. Remove the USB cable, once all files have been copied, and switch the 2-pin DIP switch to “off” (to the left).
 5. Restart the Bus Coupler.
- ⇒ The image has been updated successfully. After the update, the Bus Coupler may take a little longer to start up.

7.3 List of Abbreviations

ADS

Automation Device Specification (disclosed protocol for the communication of all BECKHOFF controllers)

DAP

Device Access Point

I/O

Inputs and outputs

E-bus

Designation for EtherCAT terminals in the terminal group (ELxxxx, ESxxxx, or EMxxxx)

EtherCAT

EtherCAT (Ethernet for Control Automation Technology) is the Ethernet solution for industrial automation, characterized by outstanding performance and particularly simple handling.

Fast Ethernet

Data rate 100 Mbits/s according to the 100 Base-T standard.

Device name

The device name in the case of PROFINET corresponds in type to the address in the case of Profibus. Most devices have no name at the time of the initial commissioning and must be given a name by the controller or supervisor. However, most BECKHOFF devices also enable a default name to be set by DIP switch, so that the naming of the devices is dispensed with.

GSDML

Basic device file for PROFINET in XML format (corresponds to the GSD file in the case of PROFIBUS).

IP20

Protection class of the Bus Terminals, EtherCAT Terminals

IPC

Industrial PC

K-bus

Terminal bus (KLxxxx, KMxxxx or KSxxxx terminals)

KS2000

Configuration software for Bus Terminals, Bus Couplers, Bus Terminal Controllers, fieldbus box modules, etc.

PE

The PE power contact can be used as a protective earth.

PROFINET

This is a further development of PROFIBUS and is based on Ethernet technology. PROFINET is described in IEC 61158.

PROFINET IO

This is the generic term for PROFINET communication and describes the concept.

PROFINET controller

This is the name for the PROFINET master for the PROFINET devices (slaves)

PROFINET device

This is the name for the slaves on the PROFINET controller (master)

TwinCAT

The Windows Control and Automation Technology, programmer and configuration tool from the BECKHOFF Automation.

7.4 Support and Service

Beckhoff and their partners around the world offer comprehensive support and service, making available fast and competent assistance with all questions related to Beckhoff products and system solutions.

Beckhoff's branch offices and representatives

Please contact your Beckhoff branch office or representative for local support and service on Beckhoff products!

The addresses of Beckhoff's branch offices and representatives round the world can be found on her internet pages: www.beckhoff.com

You will also find further documentation for Beckhoff components there.

Support

The Beckhoff Support offers you comprehensive technical assistance, helping you not only with the application of individual Beckhoff products, but also with other, wide-ranging services:

- support
- design, programming and commissioning of complex automation systems
- and extensive training program for Beckhoff system components

Hotline: +49 5246 963 157
e-mail: support@beckhoff.com
web: www.beckhoff.com/support

Service

The Beckhoff Service Center supports you in all matters of after-sales service:

- on-site service
- repair service
- spare parts service
- hotline service

Hotline: +49 5246 963 460
e-mail: service@beckhoff.com
web: www.beckhoff.com/service

Headquarters Germany

Beckhoff Automation GmbH & Co. KG

Hülshorstweg 20
33415 Verl
Germany

Phone: +49 5246 963 0
e-mail: info@beckhoff.com
web: www.beckhoff.com

More Information:
www.beckhoff.com/EK9300

Beckhoff Automation GmbH & Co. KG
Hülshorstweg 20
33415 Verl
Germany
Phone: +49 5246 9630
info@beckhoff.com
www.beckhoff.com

