

Documentation | EN

# EK112x, EK15xx

EtherCAT Junctions

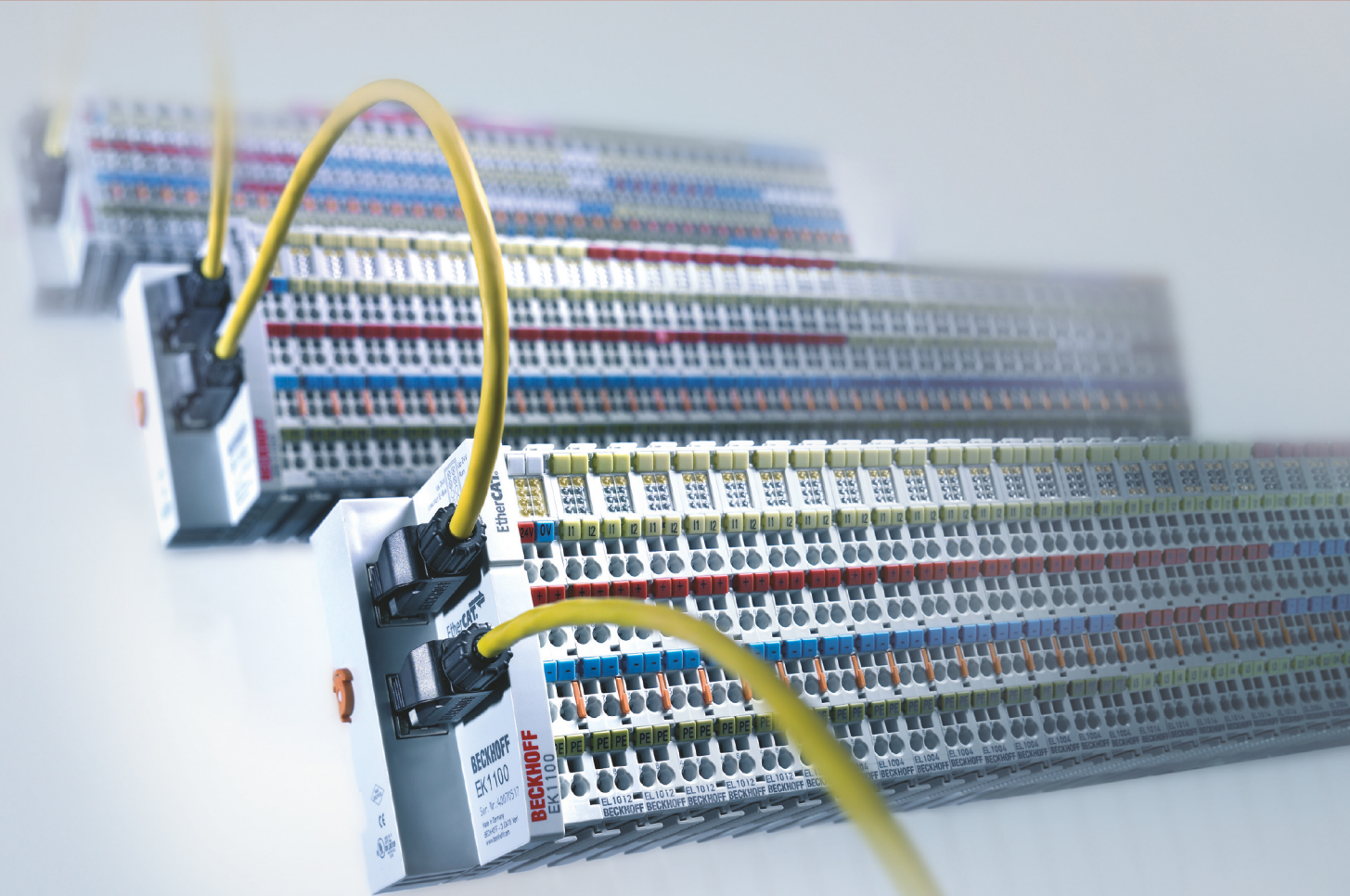



# Table of contents

<b>1</b>	<b>Foreword</b>	<b>5</b>
1.1	Overview EtherCAT Junctions	5
1.2	Notes on the documentation	6
1.3	Safety instructions	7
1.4	Guide through documentation	8
1.5	Documentation issue status	9
1.6	Version identification of EtherCAT devices	10
1.6.1	General notes on marking	10
1.6.2	Version identification of EK Couplers	11
1.6.3	Beckhoff Identification Code (BIC)	12
1.6.4	Electronic access to the BIC (eBIC)	14
<b>2</b>	<b>Product overview</b>	<b>16</b>
2.1	Junction with RJ45 connection	16
2.1.1	EK1122, EK1122-0080	16
2.1.2	EK1121-0010	22
2.2	Junctions with M8 connection	26
2.2.1	EK1122-0008	26
2.3	Junctions with fiber optic connection	28
2.3.1	EK1521	28
2.3.2	EK1521-0010	30
2.4	Junctions with POF connection	32
2.4.1	EK1561	32
<b>3</b>	<b>Commissioning/application notes</b>	<b>34</b>
3.1	Application notes RJ45 junction	34
3.1.1	EK1121-0010 - Settings and port assignment	34
3.1.2	EK1122 - Settings and port assignment	35
3.2	Application notes M8 junction	36
3.2.1	EK1122-0008 - Settings and port assignment	36
3.3	Application notes fiber optic junction	37
3.3.1	Principles of fiber-optic technology	38
3.3.2	EK1521-00x0 - Settings and port assignment	43
3.3.3	Notes on suitable optical fiber cables	44
3.3.4	Application with EK1521 and EK1521-0010	45
3.4	Application notes POF junction	47
3.4.1	EK1561 - Settings and port assignment	47
3.4.2	Notes regarding suitable POF cables	48
3.4.3	Application with EK1561	49
3.5	Notes regarding assembly of POF cables with the connector set ZS1090-0008	51
<b>4</b>	<b>Error handling and diagnostics</b>	<b>55</b>
4.1	Diagnostic LEDs EK1121-0010, EK1122, EK1122-0008	55
4.2	Diagnostic LEDs EK1521, EK1521-0010	56
4.3	Diagnostic LEDs EK1561	57
<b>5</b>	<b>Mounting and wiring</b>	<b>58</b>

5.1	Instructions for ESD protection .....	58
5.2	Explosion protection .....	59
5.2.1	ATEX - Special conditions (extended temperature range).....	59
5.2.2	IECEX - Special conditions .....	60
5.2.3	Continuative documentation for ATEX and IECEX.....	61
5.2.4	cFMus - Special conditions .....	62
5.2.5	Continuative documentation for cFMus.....	63
5.3	UL notice .....	63
5.4	Installation on mounting rails.....	64
5.5	Mounting and demounting - top front unlocking .....	66
5.6	Installation positions .....	68
5.7	Connection system.....	70
5.8	Wiring .....	71
5.9	EtherCAT cabling – wire-bound .....	73
5.10	M8 Connector - Cabling .....	74
5.11	Nut torque for connectors.....	75
5.12	Note - Power supply .....	76
5.13	Power supply, potential groups .....	76
5.14	Positioning of passive Terminals.....	79
5.15	Disposal .....	80
<b>6</b>	<b>Basics.....</b>	<b>81</b>
6.1	EtherCAT basics .....	81
6.2	Basic function principles of EtherCAT junctions.....	81
6.3	EtherCAT State Machine .....	88
6.4	CoE - Interface: notes .....	89
6.5	EKxxxx - Optional Distributed Clocks support.....	89
<b>7</b>	<b>Appendix.....</b>	<b>92</b>
7.1	Safety instructions and behavioral rules for Class 1 laser .....	92
7.2	Firmware compatibility .....	92
7.3	Firmware Update EL/ES/EM/ELM/EP/EPP/ERPxxxx .....	92
7.3.1	Device description ESI file/XML .....	94
7.3.2	Firmware explanation.....	97
7.3.3	Updating controller firmware *.efw .....	97
7.3.4	FPGA firmware *.rbf.....	99
7.3.5	Simultaneous updating of several EtherCAT devices .....	103
7.4	Support and Service.....	104

# 1 Foreword

## 1.1 Overview EtherCAT Junctions

Connection RJ45	
<a href="#">EK1121-0010</a> [▶ 22]	1 port EtherCAT junction, extended distance
<a href="#">EK1122</a> [▶ 16]	2 port EtherCAT junction
<a href="#">EK1122-0080</a> [▶ 16]	2 port EtherCAT junction, Fast-Hot-Connect

Connection M8	
<a href="#">EK1122-0008</a> [▶ 26]	2 port EtherCAT junction

Connection Fiber optic	
<a href="#">EK1521</a> [▶ 28]	1 port EtherCAT multimode fiber optic junction
<a href="#">EK1521-0010</a> [▶ 30]	1 port EtherCAT singlemode fiber optic junction

Connection Polymeric Optical Fiber	
<a href="#">EK1561</a> [▶ 32]	1 port EtherCAT polymeric optical fiber junction

## 1.2 Notes on the documentation

### Intended audience

This description is only intended for the use of trained specialists in control and automation engineering who are familiar with the applicable national standards.

It is essential that the documentation and the following notes and explanations are followed when installing and commissioning these components.

The qualified personnel is obliged to always use the currently valid documentation.

The responsible staff must ensure that the application or use of the products described satisfy all the requirements for safety, including all the relevant laws, regulations, guidelines and standards.

### Disclaimer

The documentation has been prepared with care. The products described are, however, constantly under development.

We reserve the right to revise and change the documentation at any time and without prior announcement.

No claims for the modification of products that have already been supplied may be made on the basis of the data, diagrams and descriptions in this documentation.

### Trademarks

Beckhoff®, TwinCAT®, TwinCAT/BSD®, TC/BSD®, EtherCAT®, EtherCAT G®, EtherCAT G10®, EtherCAT P®, Safety over EtherCAT®, TwinSAFE®, XFC®, XTS® and XPlanar® are registered trademarks of and licensed by Beckhoff Automation GmbH. Other designations used in this publication may be trademarks whose use by third parties for their own purposes could violate the rights of the owners.

### Patent Pending

The EtherCAT Technology is covered, including but not limited to the following patent applications and patents: EP1590927, EP1789857, EP1456722, EP2137893, DE102015105702 with corresponding applications or registrations in various other countries.



EtherCAT® is registered trademark and patented technology, licensed by Beckhoff Automation GmbH, Germany.

### Copyright

© Beckhoff Automation GmbH & Co. KG, Germany.

The reproduction, distribution and utilization of this document as well as the communication of its contents to others without express authorization are prohibited.

Offenders will be held liable for the payment of damages. All rights reserved in the event of the grant of a patent, utility model or design.

## 1.3 Safety instructions

### Safety regulations

Please note the following safety instructions and explanations!  
Product-specific safety instructions can be found on following pages or in the areas mounting, wiring, commissioning etc.

### Exclusion of liability

All the components are supplied in particular hardware and software configurations appropriate for the application. Modifications to hardware or software configurations other than those described in the documentation are not permitted, and nullify the liability of Beckhoff Automation GmbH & Co. KG.

### Personnel qualification

This description is only intended for trained specialists in control, automation and drive engineering who are familiar with the applicable national standards.

### Signal words

The signal words used in the documentation are classified below. In order to prevent injury and damage to persons and property, read and follow the safety and warning notices.

#### Personal injury warnings

**⚠ DANGER**

Hazard with high risk of death or serious injury.

**⚠ WARNING**

Hazard with medium risk of death or serious injury.

**⚠ CAUTION**

There is a low-risk hazard that could result in medium or minor injury.

#### Warning of damage to property or environment

**NOTICE**

The environment, equipment, or data may be damaged.

#### Information on handling the product



This information includes, for example:  
recommendations for action, assistance or further information on the product.

## 1.4 Guide through documentation

### NOTICE



#### Further components of documentation

This documentation describes device-specific content. It is part of the modular documentation concept for Beckhoff I/O components. For the use and safe operation of the device / devices described in this documentation, additional cross-product descriptions are required, which can be found in the following table.

Title	Description
<b>EtherCAT System Documentation</b> ( <a href="#">PDF</a> )	<ul style="list-style-type: none"> <li>• System overview</li> <li>• EtherCAT basics</li> <li>• Cable redundancy</li> <li>• Hot Connect</li> <li>• EtherCAT devices configuration</li> </ul>
<b>Explosion Protection for Terminal Systems</b> ( <a href="#">PDF</a> )	Notes on the use of the Beckhoff terminal systems in hazardous areas according to ATEX and IECEx
<b>Control Drawing I/O, CX, CPX</b> ( <a href="#">PDF</a> )	Connection diagrams and Ex markings (conform to cFMus)
<b>Infrastructure for EtherCAT/Ethernet</b> ( <a href="#">PDF</a> )	Technical recommendations and notes for design, implementation and testing
<b>Software Declarations I/O</b> ( <a href="#">PDF</a> )	Open source software declarations for Beckhoff I/O components

The documentations can be viewed at and downloaded from the Beckhoff website ([www.beckhoff.com](http://www.beckhoff.com)) via:

- the “Documentation and Download” area of the respective product page,
- the [Download finder](#),
- the [Beckhoff Information System](#).



## 1.5 Documentation issue status

Version	Modifications
3.8	<ul style="list-style-type: none"> <li>Chapter "Recommended mounting rails" removed</li> <li>Update chapter "Technical data"</li> </ul>
3.7	<ul style="list-style-type: none"> <li>Update chapter "Technical data"</li> <li>Update structure</li> </ul>
3.6	<ul style="list-style-type: none"> <li>Update chapter "Technical data"</li> <li>Update chapter "Mounting and wiring"</li> <li>Update structure</li> </ul>
3.5	<ul style="list-style-type: none"> <li>New title page</li> <li>Addenda EK1121-0010</li> <li>Update chapter "Technical data"</li> <li>Update chapter "Application notes"</li> <li>Update chapter "UL notes"</li> <li>Update structure</li> </ul>
3.4	<ul style="list-style-type: none"> <li>Update chapter "Technical data"</li> <li>Update structure</li> </ul>
3.3	<ul style="list-style-type: none"> <li>Update chapter "Notes on the documentation"</li> <li>Update chapter "Technical data"</li> <li>Addenda chapter "Instructions for ESD protection"</li> <li>Chapter "ATEX - Special conditions" replaced with chapter "ATEX - Special conditions (extended temperature range)"</li> </ul>
3.2	<ul style="list-style-type: none"> <li>Corrections within chapter "Technical data"</li> </ul>
3.1	<ul style="list-style-type: none"> <li>Corrections within chapter "Basic function principles of EtherCAT junctions"</li> </ul>
3.0	<ul style="list-style-type: none"> <li>Addenda of EK1122-0008 (EtherCAT coupler, with M8 sockets);</li> <li>Migration</li> </ul>
2.4	<ul style="list-style-type: none"> <li>Update chapter "Mounting and wiring"</li> <li>Update chapter "Technical data"</li> <li>Update structure</li> </ul>
2.3	<ul style="list-style-type: none"> <li>Update Technical data</li> </ul>
2.2	<ul style="list-style-type: none"> <li>Update Technical data</li> </ul>
2.1	<ul style="list-style-type: none"> <li>Addenda chapter "Optional DC support"</li> </ul>
2.0	<ul style="list-style-type: none"> <li>Addenda EK1122-0080</li> </ul>
1.9	<ul style="list-style-type: none"> <li>Application notes POF junction added</li> </ul>
1.8	<ul style="list-style-type: none"> <li>EK1561 added</li> </ul>
1.7	<ul style="list-style-type: none"> <li>Update chapter "Diagnostic LEDs"</li> </ul>
1.6	<ul style="list-style-type: none"> <li>Technical notes added, structure adjusted</li> </ul>
1.5	<ul style="list-style-type: none"> <li>EK1521-0010 added</li> </ul>
1.4	<ul style="list-style-type: none"> <li>Note PC plug added</li> </ul>
1.3	<ul style="list-style-type: none"> <li>Port assignment added</li> </ul>
1.2	<ul style="list-style-type: none"> <li>Addenda technical notes</li> </ul>
1.1	<ul style="list-style-type: none"> <li>Technical description added</li> </ul>
1.0	<ul style="list-style-type: none"> <li>First public issue</li> </ul>
0.1	<ul style="list-style-type: none"> <li>Preliminary version</li> </ul>

## 1.6 Version identification of EtherCAT devices

### 1.6.1 General notes on marking

#### Designation

A Beckhoff EtherCAT device has a 14-digit designation, made up of

- family key
- type
- version
- revision

Example	Family	Type	Version	Revision
EL3314-0000-0016	EL terminal 12 mm, non-pluggable connection level	3314 4-channel thermocouple terminal	0000 basic type	0016
ES3602-0010-0017	ES terminal 12 mm, pluggable connection level	3602 2-channel voltage measurement	0010 high-precision version	0017
CU2008-0000-0000	CU device	2008 8-port fast ethernet switch	0000 basic type	0000

#### Notes

- The elements mentioned above result in the **technical designation**. EL3314-0000-0016 is used in the example below.
- EL3314-0000 is the order identifier, in the case of “-0000” usually abbreviated to EL3314. “-0016” is the EtherCAT revision.
- The **order identifier** is made up of
  - family key (EL, EP, CU, ES, KL, CX, etc.)
  - type (3314)
  - version (-0000)
- The **revision** -0016 shows the technical progress, such as the extension of features with regard to the EtherCAT communication, and is managed by Beckhoff.  
In principle, a device with a higher revision can replace a device with a lower revision, unless specified otherwise, e.g. in the documentation.  
Associated and synonymous with each revision there is usually a description (ESI, EtherCAT Slave Information) in the form of an XML file, which is available for download from the Beckhoff web site.  
From 2014/01 the revision is shown on the outside of the IP20 terminals, see Fig. “EL5021 EL terminal, standard IP20 IO device with batch number and revision ID (since 2014/01)”.
- The type, version and revision are read as decimal numbers, even if they are technically saved in hexadecimal.

## 1.6.2 Version identification of EK Couplers

The serial number/ data code for Beckhoff IO devices is usually the 8-digit number printed on the device or on a sticker. The serial number indicates the configuration in delivery state and therefore refers to a whole production batch, without distinguishing the individual modules of a batch.

Structure of the serial number: **KK YY FF HH**

KK - week of production (CW, calendar week)

YY - year of production

FF - firmware version

HH - hardware version

Example with serial number 12 06 3A 02:

12 - production week 12

06 - production year 2006

3A - firmware version 3A

02 - hardware version 02



Fig. 1: EK1101 EtherCAT coupler with revision 0815 and serial number 41130206

### 1.6.3 Beckhoff Identification Code (BIC)

The Beckhoff Identification Code (BIC) is increasingly being applied to Beckhoff products to uniquely identify the product. The BIC is represented as a Data Matrix Code (DMC, code scheme ECC200), the content is based on the ANSI standard MH10.8.2-2016.

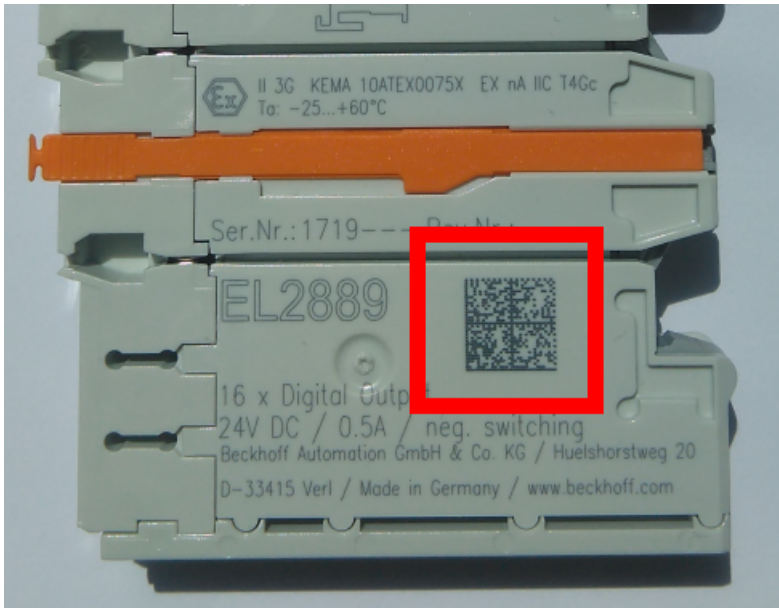

Fig. 2: BIC as data matrix code (DMC, code scheme ECC200)

The BIC will be introduced step by step across all product groups.

Depending on the product, it can be found in the following places:

- on the packaging unit
- directly on the product (if space suffices)
- on the packaging unit and the product

The BIC is machine-readable and contains information that can also be used by the customer for handling and product management.

Each piece of information can be uniquely identified using the so-called data identifier (ANSI MH10.8.2-2016). The data identifier is followed by a character string. Both together have a maximum length according to the table below. If the information is shorter, spaces are added to it.

Following information is possible, positions 1 to 4 are always present, the other according to need of production:

Position	Type of information	Explanation	Data identifier	Number of digits incl. data identifier	Example
1	Beckhoff order number	<b>Beckhoff order number</b>	1P	8	1P072222
2	Beckhoff Traceability Number (BTN)	<b>Unique serial number, see note below</b>	SBTN	12	SBTNk4p562d7
3	Article description	<b>Beckhoff article description, e.g. EL1008</b>	1K	32	1KEL1809
4	Quantity	<b>Quantity in packaging unit, e.g. 1, 10, etc.</b>	Q	6	Q1
5	Batch number	Optional: Year and week of production	2P	14	2P401503180016
6	ID/serial number	Optional: Present-day serial number system, e.g. with safety products	51S	12	51S678294
7	Variant number	Optional: Product variant number on the basis of standard products	30P	32	30PF971, 2*K183
...					

Further types of information and data identifiers are used by Beckhoff and serve internal processes.

### Structure of the BIC

Example of composite information from positions 1 to 4 and with the above given example value on position 6. The data identifiers are highlighted in bold font:

**1**P072222**S**BTNk4p562d7**1**KEL1809 **Q1** **51S**678294

Accordingly as DMC:



Fig. 3: Example DMC **1**P072222**S**BTNk4p562d7**1**KEL1809 **Q1** **51S**678294

### BTN

An important component of the BIC is the Beckhoff Traceability Number (BTN, position 2). The BTN is a unique serial number consisting of eight characters that will replace all other serial number systems at Beckhoff in the long term (e.g. batch designations on IO components, previous serial number range for safety products, etc.). The BTN will also be introduced step by step, so it may happen that the BTN is not yet coded in the BIC.

#### **NOTICE**

This information has been carefully prepared. However, the procedure described is constantly being further developed. We reserve the right to revise and change procedures and documentation at any time and without prior notice. No claims for changes can be made from the information, illustrations and descriptions in this information.

## 1.6.4 Electronic access to the BIC (eBIC)

### Electronic BIC (eBIC)

The Beckhoff Identification Code (BIC) is applied to the outside of Beckhoff products in a visible place. If possible, it should also be electronically readable.

Decisive for the electronic readout is the interface via which the product can be electronically addressed.

### K-bus devices (IP20, IP67)

Currently, no electronic storage and readout is planned for these devices.

### EtherCAT devices (IP20, IP67)

All Beckhoff EtherCAT devices have a so-called ESI-EEPROM, which contains the EtherCAT identity with the revision number. Stored in it is the EtherCAT slave information, also colloquially known as ESI/XML configuration file for the EtherCAT master. See the corresponding chapter in the EtherCAT system manual ([Link](#)) for the relationships.

The eBIC is also stored in the ESI-EEPROM. The eBIC was introduced into the Beckhoff I/O production (terminals, box modules) from 2020; widespread implementation is expected in 2021.

The user can electronically access the eBIC (if existent) as follows:

- With all EtherCAT devices, the EtherCAT master (TwinCAT) can read the eBIC from the ESI-EEPROM
  - From TwinCAT 3.1 build 4024.11, the eBIC can be displayed in the online view.
  - To do this, check the checkbox "Show Beckhoff Identification Code (BIC)" under EtherCAT → Advanced Settings → Diagnostics:

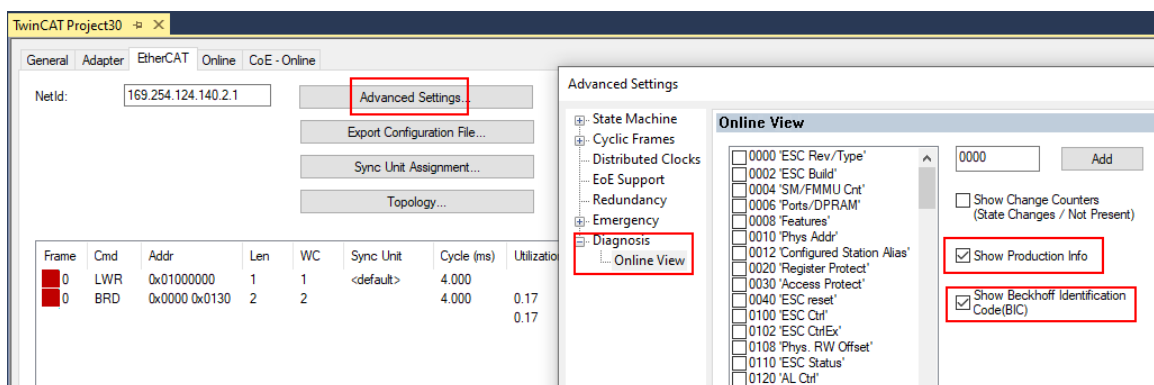

- The BTN and its contents are then displayed:

No	Addr	Name	State	CRC	Fw	Hw	Production Data	ItemNo	BTN	Description	Quantity	BatchNo	SerialNo
1	1001	Term 1 (EK1100)	OP	0.0	0	0	---						
2	1002	Term 2 (EL1018)	OP	0.0	0	0	2020 KW36 Fr	072222	k4p562d7	EL1809	1		678294
3	1003	Term 3 (EL3204)	OP	0.0	7	6	2012 KW24 Sa						
4	1004	Term 4 (EL2004)	OP	0.0	0	0	---	072223	k4p562d7	EL2004	1		678295
5	1005	Term 5 (EL1008)	OP	0.0	0	0	---						
6	1006	Term 6 (EL2008)	OP	0.0	0	12	2014 KW14 Mo						
7	1007	Term 7 (EK1110)	OP	0	1	8	2012 KW25 Mo						

- Note: as can be seen in the illustration, the production data HW version, FW version and production date, which have been programmed since 2012, can also be displayed with "Show Production Info".
- Access from the PLC: From TwinCAT 3.1. build 4024.24 the functions *FB\_EcReadBIC* and *FB\_EcReadBTN* are available in the Tc2\_EtherCAT Library from v3.3.19.0 for reading into the PLC..
- In the case of EtherCAT devices with CoE directory, the object 0x10E2:01 can additionally be used to display the device's own eBIC; the PLC can also simply access the information here:

- The device must be in PREOP/SAFEOP/OP for access:

Index	Name	Flags	Value
1000	Device type	RO	0x015E1389 (22942601)
1008	Device name	RO	ELM3704-0000
1009	Hardware version	RO	00
100A	Software version	RO	01
100B	Bootloader version	RO	J0.1.27.0
1011:0	Restore default parameters	RO	> 1 <
1018:0	Identity	RO	> 4 <
10E2:0	Manufacturer-specific Identification C...	RO	> 1 <
10E2:01	SubIndex 001	RO	1P158442SBTN0008jckp1KELM3704 Q1 2P482001000016
10F0:0	Backup parameter handling	RO	> 1 <
10F3:0	Diagnosis History	RO	> 21 <
10F8	Actual Time Stamp	RO	0x170bf277e

- The object 0x10E2 will be introduced into stock products in the course of a necessary firmware revision.
- From TwinCAT 3.1. build 4024.24 the functions *FB\_EcCoEReadBIC* and *FB\_EcCoEReadBTN* are available in the *Tc2\_EtherCAT Library* from v3.3.19.0 for reading into the PLC.
- For processing the BIC/BTN data in the PLC, the following auxiliary functions are available in *Tc2\_Uilities* from TwinCAT 3.1 build 4024.24 onwards
  - *F\_SplitBIC*: The function splits the Beckhoff Identification Code (BIC) *sBICValue* into its components based on known identifiers and returns the recognized partial strings in a structure *ST\_SplitBIC* as return value.
  - *BIC\_TO\_BTN*: The function extracts the BTN from the BIC and returns it as a value.
- Note: in the case of electronic further processing, the BTN is to be handled as a string(8); the identifier "SBTN" is not part of the BTN.
- Technical background
 

The new BIC information is additionally written as a category in the ESI-EEPROM during the device production. The structure of the ESI content is largely dictated by the ETG specifications, therefore the additional vendor-specific content is stored with the help of a category according to ETG.2010. ID 03 indicates to all EtherCAT masters that they must not overwrite these data in case of an update or restore the data after an ESI update.

The structure follows the content of the BIC, see there. This results in a memory requirement of approx. 50..200 bytes in the EEPROM.
- Special cases
  - If multiple, hierarchically arranged ESCs are installed in a device, only the top-level ESC carries the eBIC Information.
  - If multiple, non-hierarchically arranged ESCs are installed in a device, all ESCs carry the eBIC Information.
  - If the device consists of several sub-devices with their own identity, but only the top-level device is accessible via EtherCAT, the eBIC of the top-level device is located in the CoE object directory 0x10E2:01 and the eBICs of the sub-devices follow in 0x10E2:nn.

**PROFIBUS, PROFINET, DeviceNet devices etc.**

Currently, no electronic storage and readout is planned for these devices.

## 2 Product overview

### 2.1 Junction with RJ45 connection

#### 2.1.1 EK1122, EK1122-0080

##### 2.1.1.1 Introduction

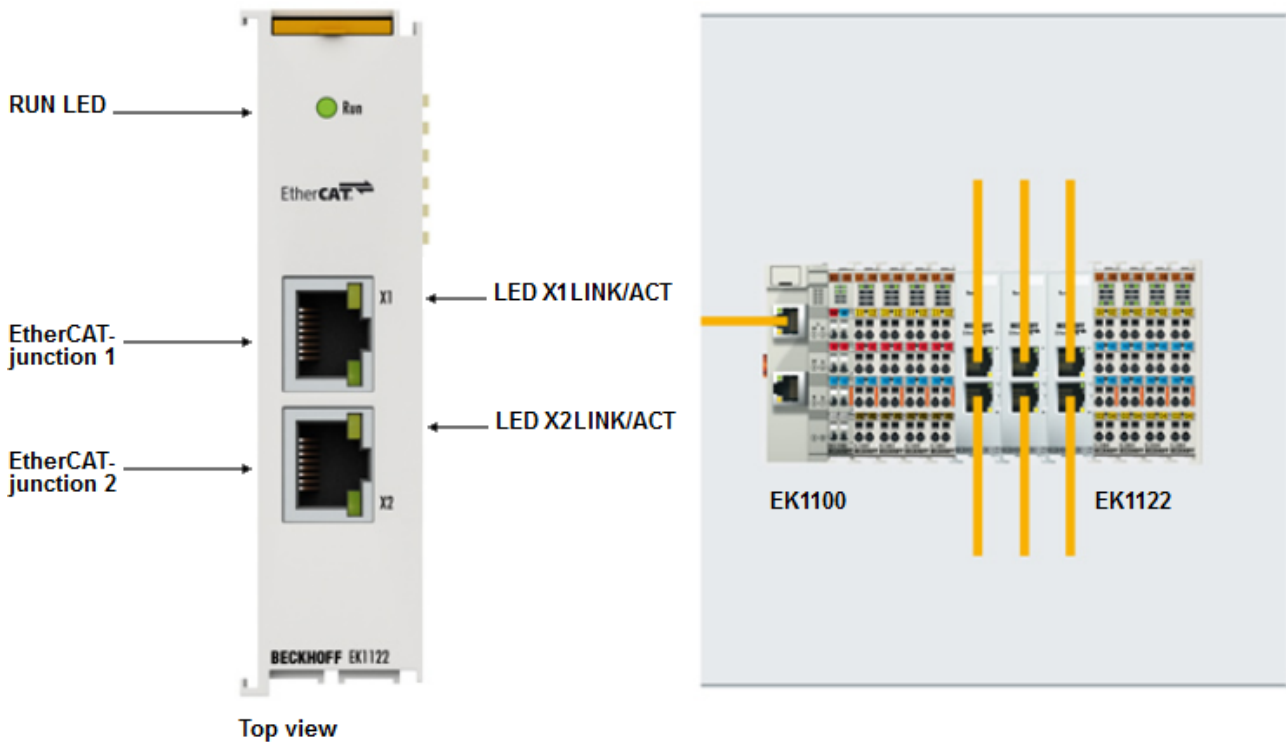

Fig. 4: EK1122-xxxx

#### EK1122-0000

The 2-port EtherCAT junction enables configuration of EtherCAT star topologies. A modular EtherCAT star hub can be realized by using several EK1122 units in a station. Individual devices or complete EtherCAT strands can be connected at the junction ports. The EtherCAT junctions are connected via RJ-45 sockets with direct display of link and activity status. The Run LED indicates the status of the EK1122. Through TwinCAT and other suitable EtherCAT masters the EK1122 also supports coupling and uncoupling of EtherCAT strands during operation (hot connect).

#### EK1122-0080

Hot Connect is an EtherCAT feature for changing topologies through direct coupling or uncoupling during operation. Coupled EtherCAT components are already quickly linked to the data communication after connection as standard. Fast hot-connect technology further reduces the connection time significantly, enabling even faster tool changes. Fast hot-connect ports may only be connected to each other, which is why they are specially identified.

The EK1122-0080 EtherCAT junction with Fast Hot Connect is complemented by the EK1101-0080 EtherCAT coupler with Fast Hot Connect.

#### **i** Fast Hot Connect ports at the EK1122-0080

In contrast to the EK1122, the RJ45 connections of the FHC ports of the EK1122-0080 are marked with a dotted border (see following Figure) Explanatory notes can be found in chapter [EtherCAT Fast-Hot-Connect](#) [► 19].





Fig. 5: Fast-Hot-Connect ports at the EK1122-0080

**Connection**

Terminal point	Description
Designation	
X1/X2	RJ45 connection for EtherCAT networks (100BASE-TX Ethernet signal representation)

**Quick links**

- [EtherCAT basics](#)
- [Notes on Fast Hot Connect \[▶ 19\]](#)
- [Application notes \[▶ 34\]](#)
- [Diagnostic LEDs \[▶ 55\]](#)

### 2.1.1.2 Technical data

Technical data	EK1122	EK1122-0080
Task within the EtherCAT system	Coupling of EtherCAT junctions	Coupling of EtherCAT junctions, Fast-Hot-Connect technology [▶ 19]
Transmission medium	Ethernet/EtherCAT cable (min. CAT5), shielded	
Cable length between two Bus Couplers	max. 100 m (100BASE-TX)	
Protocol	EtherCAT	
Data transfer rates	100 Mbit/s	
Bus connection	2 x RJ45	
Delay	typ. 1 µs	
Configuration	no address and configuration settings required	

General data	EK1122	EK1122-0080
Power supply	from E-bus	
Current consumption	typ. 220 mA	
Dimensions (W x H x D)	approx. 26 mm x 100 mm x 52 mm (width aligned: 23 mm)	
Weight	approx. 70 g	
Permissible ambient temperature range during operation	-25°C ... +60°C (extended temperature range)	
Permissible ambient temperature range during storage	-40°C ... +85°C	
Permissible relative humidity	95%, no condensation	
Mounting [▶ 58]	on 35 mm mounting rail conforms to EN 60715	
Vibration / shock resistance	conforms to EN 60068-2-6 / EN 60068-2-27	
EMC immunity / emission	conforms to EN 61000-6-2 / EN 61000-6-4	
Protection class	IP20	
Installation position	Variable	
Approvals / markings*	CE, UKCA, EAC, cULus [▶ 63], ATEX [▶ 59], IECEx [▶ 60], cFMus [▶ 62]	CE, UKCA, EAC cULus [▶ 63], ATEX [▶ 59], IECEx [▶ 60]

\*) Real applicable approvals/markings see type plate on the side (product marking).

#### EK1122:

##### Ex markings

Standard	Marking
ATEX	II 3 G Ex nA IIC T4 Gc
IECEX	Ex nA IIC T4 Gc
cFMus	Class I, Division 2, Groups A, B, C, D Class I, Zone 2, AEx/Ex ec IIC T4 Gc

#### EK1122-0080:

##### Ex markings

Standard	Marking
ATEX	II 3 G Ex nA IIC T4 Gc
IECEX	Ex nA IIC T4 Gc

**2.1.1.3 Notes re. EtherCAT Fast Hot Connect technology**

EtherCAT components that support Fast Hot Connect enable a faster fieldbus boot up following the establishment of a connection. The boot up depends in detail on the number of devices, the topology and activated Distributed Clocks. Whereas the normal establishment of a connection and communication takes several seconds, less than 1 second is possible with FHC components.

**Properties and system behavior**

- Fast Hot Connect is supported from TwinCAT 2.11R3 Build 2221.
- Fast Hot Connect ports are specially marked.



Fig. 6: Identification of FHC port at EK1122-0080 and EK1101-0080

- Standard EtherCAT devices may not be connected to Fast Hot Connect ports. This is to be ensured by measures on the application side, which is easy to implement by means of the topology change that is usually carried out mechanically in such applications.

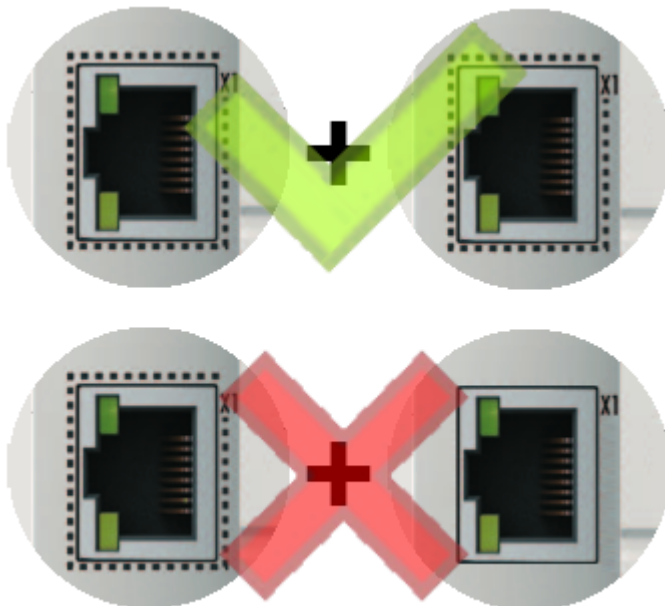

Fig. 7: Recommended combination of Ethernet ports

- If corresponding ports are nevertheless connected, a power reset of the devices involved (branch terminal and coupler/box) is required.

- With Fast Hot Connect devices the establishment of an Ethernet connection is accelerated compared to the normal Fast Ethernet connection.  
If in addition the use of Distributed Clocks functions is omitted in the entire topology, then the resynchronization time of the components is also dispensed with. Group boot up of < 1 second is then possible, from plugging in the Ethernet connection to the OP state.
- An incorrect port allocation is detected in the TwinCAT ADS Logger

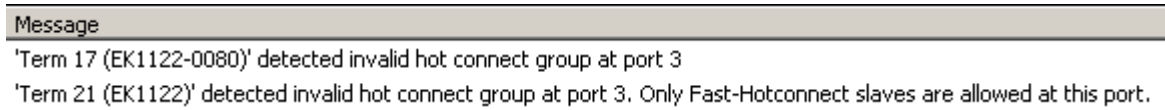

Fig. 8: Detection of incorrect port allocation in the TwinCAT logger

**Configuration**

The configuration of Fast Hot Connect groups in the TwinCAT System Manager takes place in exactly the same way as Hot Connect groups, specifying the associated group ID.

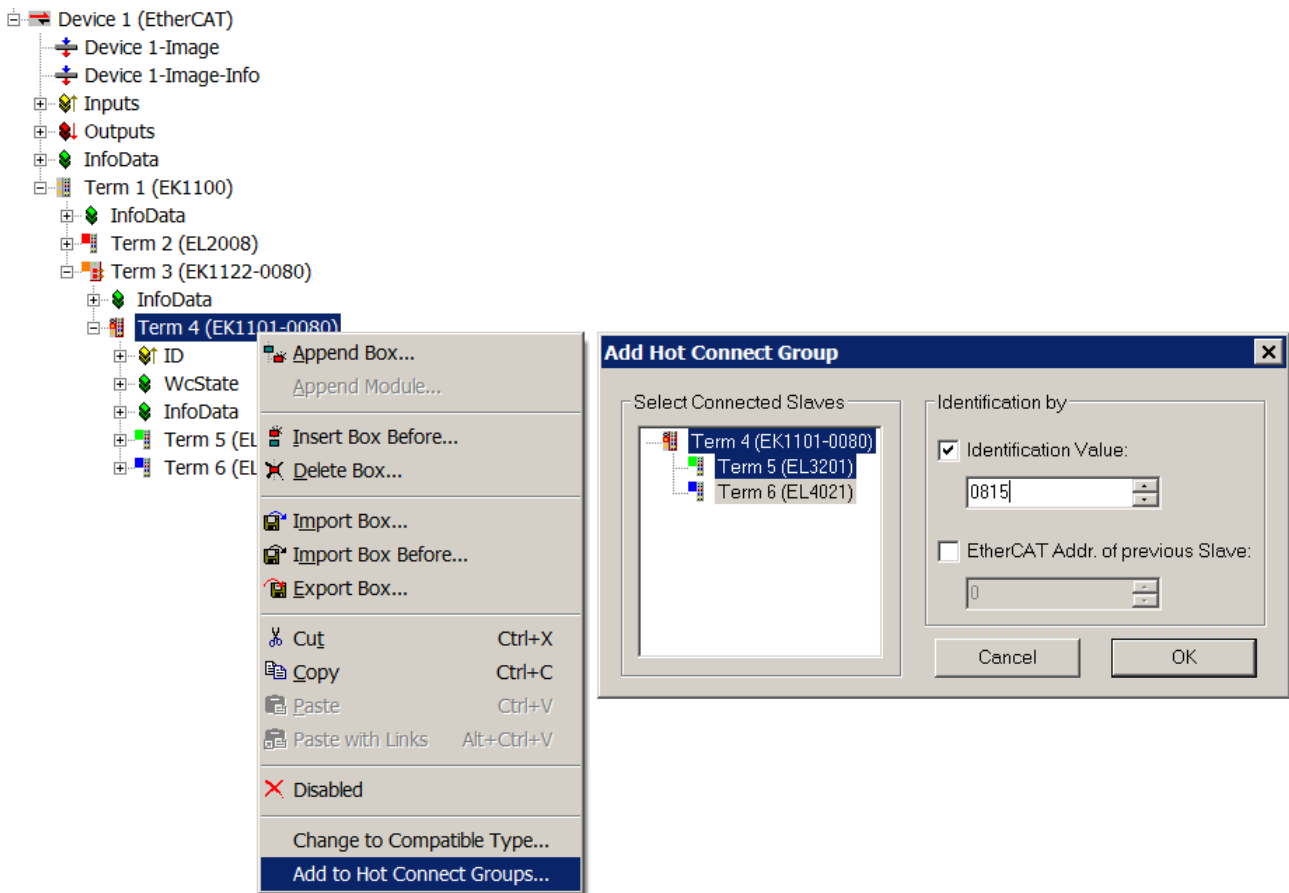

Fig. 9: Configuration of a Fast Hot Connect group

Corresponding Fast Hot Connect ports are marked red in the TwinCAT System Manager.

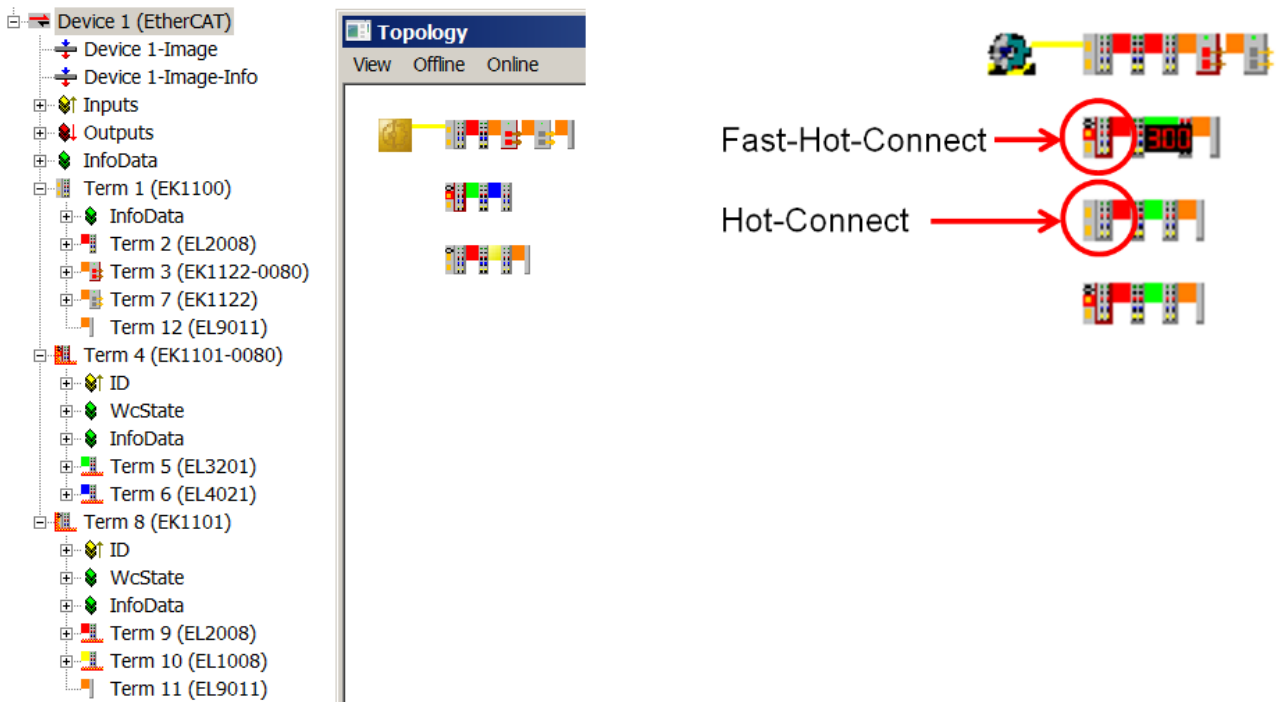

Fig. 10: Marking in the TwinCAT System Manager

A configuration of FHC groups is possible only if at least 1 corresponding junction is present e.g. EK1122-0080.

**Distributed Clocks**

If no Distributed Clocks functions are used, this is visible in the master settings by the absence of “DC in use”:

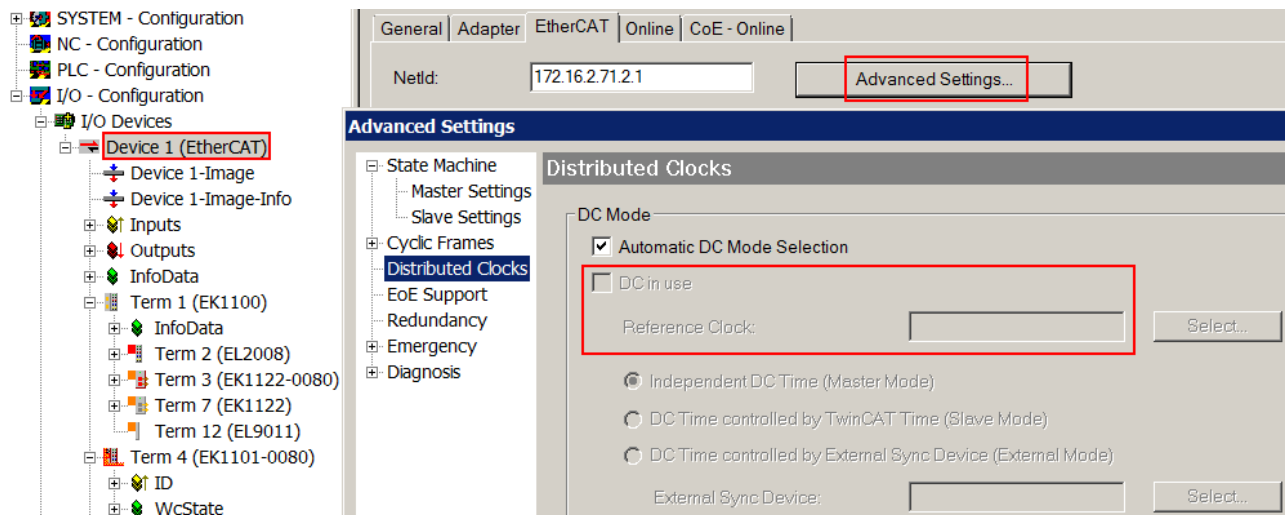

Fig. 11: DC master setting

This setting is automatically selected by the System Manager if there are no EtherCAT slaves in the configuration in which Distributed Clocks is activated. “DC in use” should not be randomly deactivated by the user, because otherwise these devices will no longer function.

## 2.1.2 EK1121-0010

### 2.1.2.1 Introduction

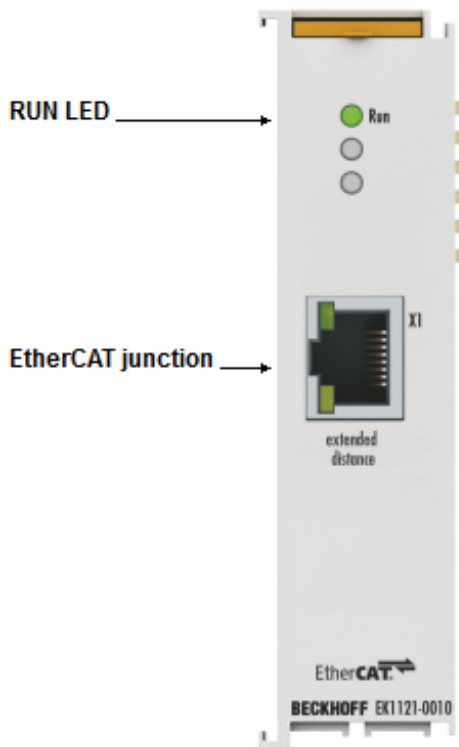

Fig. 12: EK1121-0010

### EK1121-0010

In combination with an EtherCAT Extended Distance device e. g. EK1101-0010, the single-port EK1121-0010 EtherCAT Extended Distance junction enables the bridging of distances up to 300 m. The EK1121-0010 can be installed at any point in an EtherCAT segment between the EtherCAT Terminals (ELxxx). The EtherCAT junction is connected via an RJ45 socket. The link and activity status is displayed directly at the port next to the Run LED

### Connection

Terminal point	Description
<b>Designation</b>	
X1	RJ45 connection for EtherCAT networks (100BASE-TX Ethernet signal representation)

### Quick links

- [EtherCAT basics](#)
- [Application notes \[► 34\]](#)
- [Diagnostic LEDs \[► 55\]](#)

**2.1.2.2 Technical data**

<b>Technical data</b>	<b>EK1121-0010</b>
Task within the EtherCAT system	coupling of 100BASE-TX EtherCAT networks
Transmission medium	Ethernet/EtherCAT cable (copper, min. Cat. 5, 4-wire, AWG22), shielded
Cable length between two Bus Couplers	max. 300 m
Protocol	EtherCAT
Data transfer rates	100 Mbit/s
Configuration	no address and configuration settings required
Bus connection	1 x RJ45
Delay	typ. 1 µs
Power supply	from E-bus
Current consumption	typ. 160 mA

<b>General data</b>	<b>EK1121-0010</b>
Dimensions (W x H x D)	approx. 26 mm x 100 mm x 52 mm (width aligned: 23 mm)
Weight	approx. 65 g
Permissible ambient temperature range during operation	0°C ... +55°C
Permissible ambient temperature range during storage	-25°C ... +85°C
Permissible relative humidity	95%, no condensation
<a href="#">Mounting</a> [▶ 58]	on 35 mm mounting rail conforms to EN 60715
Vibration / shock resistance	conforms to EN 60068-2-6 / EN 60068-2-27
EMC immunity / emission	conforms to EN 61000-6-2 / EN 61000-6-4
Protection class	IP20
Installation position	variable
Approvals / markings*	CE, UKCA, EAC, <a href="#">cULus</a> [▶ 63]

\*) Real applicable approvals/markings see type plate on the side (product marking).

### 2.1.2.3 Notes on Extended Distance connection

Using components which support the Extended Distance connection, distances of up to 300 m can be bridged (for connections between two Extended Distance components). These components are marked with “extended distance” both in chapter “Technical data” and on the respective RJ45 sockets of the component. In the TwinCAT System Manager “Extended Distance” is part of the type designation (tab “General”, “Type”).

#### Topologies with Extended Distance components, distances up to 300 m

Distances of up to 300 m can be bridged between two Extended Distance components. Possible topologies are shown in the following figure.

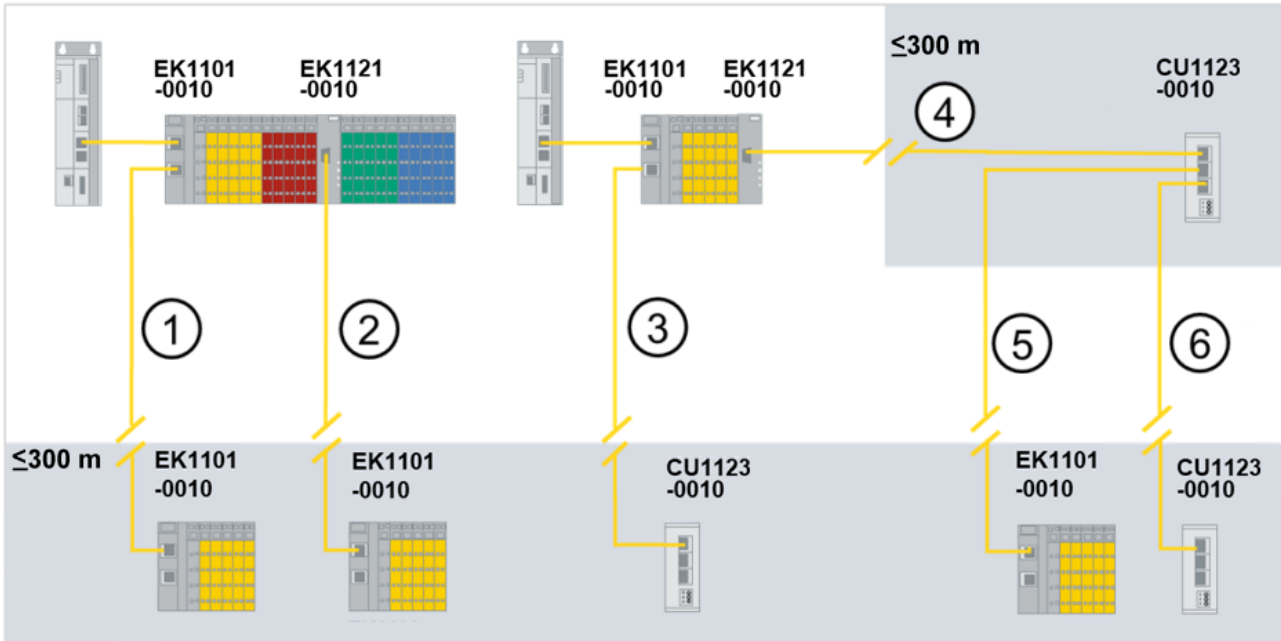

Fig. 13: Topologies with Extended Distance components, distances up to 300 m

Topologies with Extended Distance components, distances up to 300 m		
No. in the figure above	1 <sup>st</sup> Component	2 <sup>nd</sup> Component
1	EK1101-0010	EK1101-0010
2	EK1121-0010	EK1101-0010
3	EK1101-0010	CU1123-0010
4	EK1121-0010	CU1123-0010
5	CU1123-0010	EK1101-0010
6	CU1123-0010	CU1123-0010



**Not permitted topologies with Extended Distance components**

The EK1121-0010 EtherCAT junction cannot be used as a 2<sup>nd</sup> component because the EtherCAT port is not an output port. The following figure shows not permitted topologies with Extended Distance components.

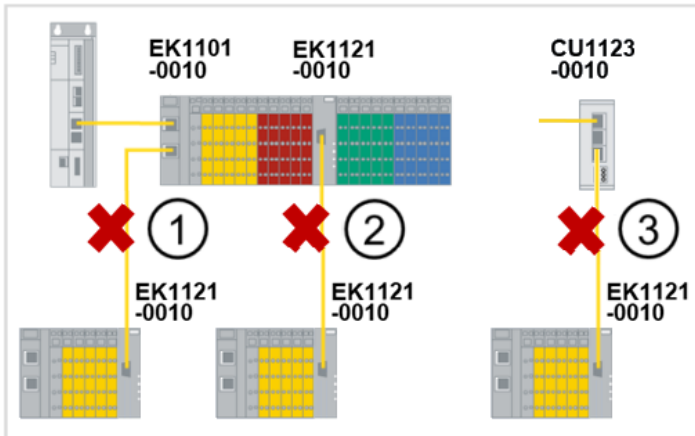

Fig. 14: Not permitted topologies with Extended Distance components

Not permitted topologies with Extended Distance components		
No. in the figure above	1 <sup>st</sup> Component	2 <sup>nd</sup> Component
1	EK1101-0010	EK1121-0010
2	EK1121-0010	EK1121-0010
3	CU1123-0010	EK1101-0010

**Topologies with Extended Distance- and Standard components, distances up to 100 m**

If only one connection of the two Components is configured for Extended Distance, e.g. a connection between a standard EtherCAT Coupler (EK1100) and an EtherCAT Coupler with Extended Distance connection (EK1101-0010), the maximum distance between the stations is 100 m. In the following figure the standard components are marked with a “\*”. Standard components are detected automatically. The parameterization of the EtherCAT ports is not necessary. Examples of possible topologies are shown in the following figure.

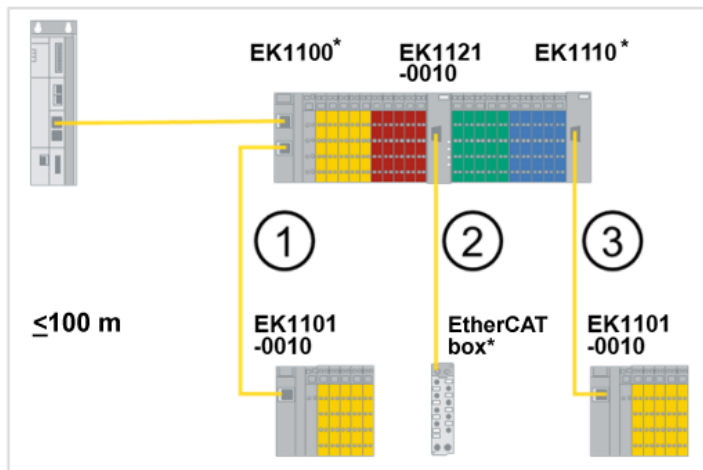

Fig. 15: Topologies with Extended Distance- and Standard components, distances up to 100 m

Not permitted topologies with Extended Distance components, distances up to 100 m		
No. in the figure above	1 <sup>st</sup> Component	2 <sup>nd</sup> Component
1	EK1100*	EK1101-0010
2	EK1121-0010	EtherCAT Box*
3	EK1100*	EK1101-0010

## 2.2 Junctions with M8 connection

### 2.2.1 EK1122-0008

#### 2.2.1.1 Introduction

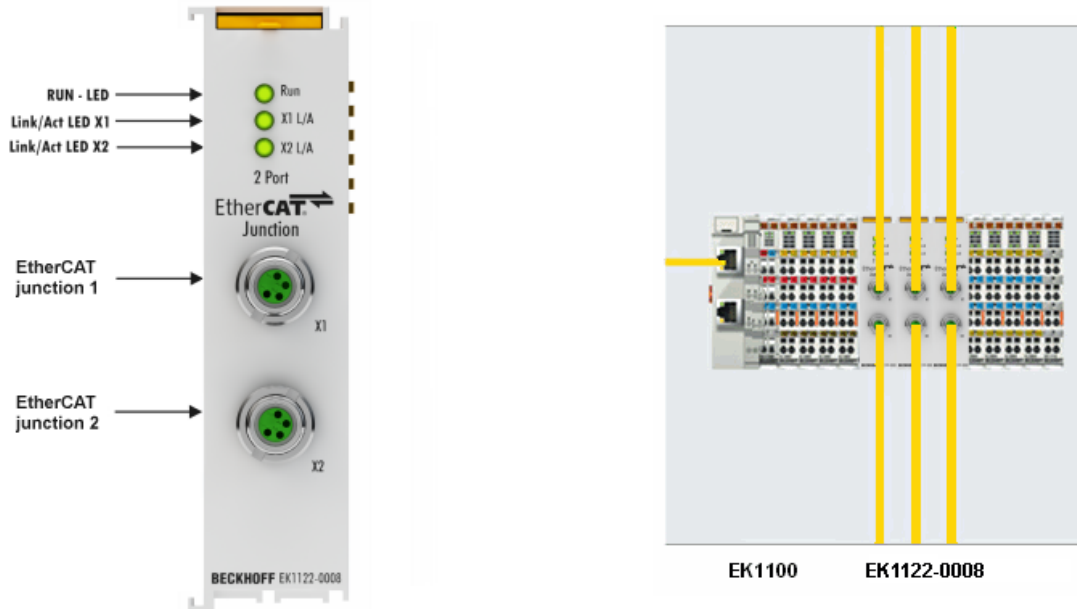

Fig. 16: EK1122-0008

#### EK1122-0008

The 2-port EtherCAT junction enables configuration of EtherCAT star topologies. A modular EtherCAT star hub can be realized by using several EK1122 units in a station. Individual devices or complete EtherCAT strands can be connected at the junction ports. Compared to EK1122 the EK1122-0008 has two M8 sockets compatible to the two RJ45 sockets instead. The EtherCAT junctions are connected via M8 sockets. The link and activity status are indicated by separate LEDs at the front. The Run LED indicates the status of the EK1122. With TwinCAT and other appropriate EtherCAT Masters the EK1122-0008 supports coupling and uncoupling of EtherCAT strands during operation (hot connect).

By using respective powerful Ethernet cables e.g. ZK1090-3131-1xxx distances of 100 m are also possible via M8.

#### Connection

Terminal point	Description
<b>Designation</b>	
X1	2 x M8 socket, shielded
X2	

#### Quick links

- [EtherCAT basics](#)
- [Diagnostic LEDs \[► 55\]](#)

### 2.2.1.2 Technical data

Technical data	EK1122-0008
Task within the EtherCAT system	Coupling of EtherCAT junctions via M8
Transmission medium	Ethernet/EtherCAT-cable (min. CAT 5), shielded
Cable length between two stations	100 m (100BASE-TX)
Protocol	EtherCAT
Data transfer rates	100 Mbit/s
Configuration	not required
Bus interface	2 x M8
Delay	approx. 1 µs
Power supply	from E-bus
E-Bus current consumption	typ. 220 mA

General data	EK1122-0008
Dimensions (W x H x D)	approx. 26 mm x 100 mm x 52 mm (width aligned: 23 mm)
Weight	approx. 65 g
Permissible ambient temperature range during operation	-25°C ... +60°C (extended temperature range)
Permissible ambient temperature range during storage	-40°C ... +85°C
Permissible relative humidity	95%, no condensation
<a href="#">Mounting</a> [▶ 58]	on 35 mm mounting rail conforms to EN 60715
Vibration / shock resistance	conforms to EN 60068-2-6 / EN 60068-2-27
EMC immunity / emission	conforms to EN 61000-6-2 / EN 61000-6-4
Protection class	IP20
Installation position	variable
Approvals / markings*	CE, UKCA, EAC, cULus [▶ 63], ATEX [▶ 59], IECEx [▶ 60], cFMus [▶ 62]

\*) Real applicable approvals/markings see type plate on the side (product marking).

### Ex markings

Standard	Marking
ATEX	II 3 G Ex nA IIC T4 Gc
IECEX	Ex nA IIC T4 Gc
cFMus	Class I, Division 2, Groups A, B, C, D Class I, Zone 2, AEx/Ex ec IIC T4 Gc

## 2.3 Junctions with fiber optic connection

### 2.3.1 EK1521

#### 2.3.1.1 Introduction

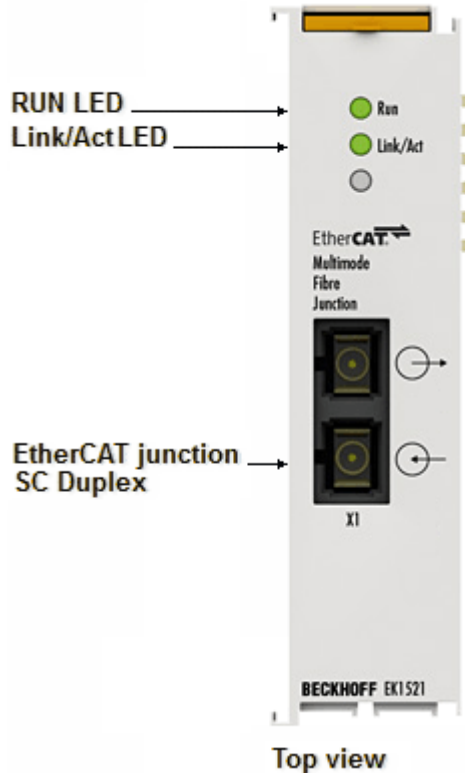

Fig. 17: EK1521

In conjunction with an EK1100 EtherCAT coupler, the 1-port EtherCAT multimode fiber optic junction enables conversion from 100Base-TX to 100Base-FX physics (glass fiber). In this way distances of up to 2 km can be bridged in conjunction with the EK1501 EtherCAT Coupler for multimode optical fibers. Even cable redundant systems with optical fiber can be realized using the 1-port EtherCAT multimode fiber optic junction. The run LED shows the status of the EK1521.

#### Connection

Terminal point	Description
Designation	
X1	SC duplex connector

#### Quick links

- [EtherCAT basics](#)
- [Application notes \[▶ 37\]](#)
- [Diagnostic LEDs \[▶ 56\]](#)

### 2.3.1.2 Technical data

Technical data	EK1521
Task within the EtherCAT system	Coupling of EtherCAT junctions
Cable length between two Bus Couplers	2,000 m (100BASE-FX) multimode glass fiber
Protocol	All EtherCAT protocols
Data transfer rates	100 Mbit/s
Delay	typ. 1 µs
Configuration	no address and configuration settings required

Optical Data	EK1521
Transmission medium	Multimode glass fiber (MM)
Transceiver wavelength	typ. 1300 nm
Bus connection	1 x SC Duplex
Minimum output power (opt.)	62,5/125 µm, NA = 0,275: -20 dBm avg. 50/125 µm, NA = 0,2: 23,5 dBm avg.
Min. necessary optical input power (sensitivity)	-31 dBm

General Data	EK1521
Power supply	from E-bus
Current consumption	typ. 350 mA
Dimensions (W x H x D)	approx. 26 mm x 100 mm x 52 mm (width aligned: 23 mm)
Weight	approx. 70 g
Permissible ambient temperature range during operation	-25°C ... +60°C (extended temperature range)
Permissible ambient temperature range during storage	-40°C ... +85°C
Permissible relative humidity	95%, no condensation
Mounting [ <a href="#">▶ 58</a> ]	on 35 mm mounting rail conforms to EN 60715
Vibration / shock resistance	conforms to EN 60068-2-6 / EN 60068-2-27
EMC immunity / emission	conforms to EN 61000-6-2 / EN 61000-6-4
Protection class	IP20
Installation position	Variable
Approvals / markings*	CE, UKCA, EAC, cULus [ <a href="#">▶ 63</a> ], ATEX [ <a href="#">▶ 59</a> ], IECEx [ <a href="#">▶ 60</a> ]

\*) Real applicable approvals/markings see type plate on the side (product marking).

#### Ex markings

Standard	Marking
ATEX	II 3 G Ex nA IIC T4 Gc
IECEX	Ex nA IIC T4 Gc

## 2.3.2 EK1521-0010

### 2.3.2.1 Introduction

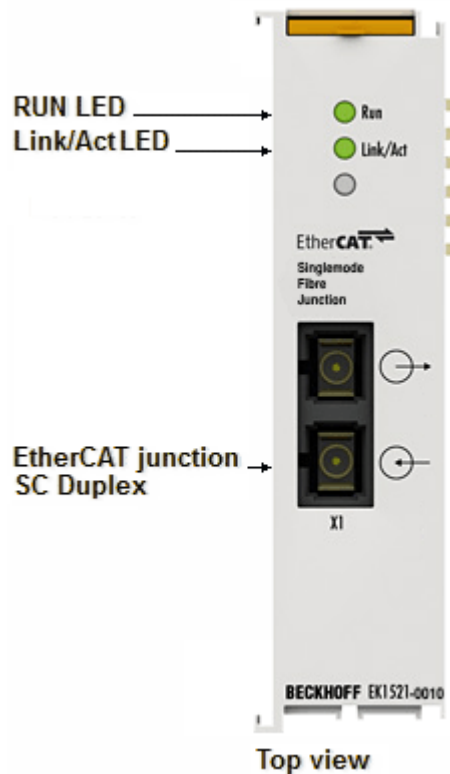

Fig. 18: EK1521-0010

In conjunction with an EK110x EtherCAT coupler, the 1-port EtherCAT single-mode fiber optic junction enables conversion from 100Base-TX to 100Base-FX physics (glass fiber). In conjunction with the EK1501-0010 EtherCAT coupler for single-mode optical glass fiber, distances of up to 20 km can be bridged. Even cable redundant systems with optical fiber can be realized using the 1-port EtherCAT single-mode fiber optic junction. The run LED shows the status of the EK1521-0010.

#### Connection

Terminal point	Description
Designation	
X1	SC duplex connector

#### Quick links

- [EtherCAT basics](#)
- [Application notes \[► 37\]](#)
- [Diagnostic LEDs \[► 56\]](#)

### 2.3.2.2 Technical data

Technical data	EK1521-0010
Task within the EtherCAT system	Coupling of EtherCAT junctions
Cable length between two Bus Couplers	20,000 m (100BASE-FX) single mode glass fiber
Protocol	All EtherCAT protocols
Data transfer rates	100 Mbit/s
Delay	typ. 1 µs
Configuration	no address and configuration settings required

Optical Data	EK1521-0010
Transmission medium	Single mode glass fiber (SM)
Transceiver wavelength	typ. 1300 nm
Bus connection	1 x SC Duplex
Minimum output power (opt.)	-15 dBm (until year of manufacture 2022) -5 dBm (from year of manufacture 2023)
Min. necessary optical input power (sensitivity)	-25 dBm (until year of manufacture 2022) -35 dBm (from year of manufacture 2023)

General Data	EK1521-0010
Power supply	from E-bus
Current consumption	typ. 350 mA
Dimensions (W x H x D)	approx. 26 mm x 100 mm x 52 mm (width aligned: 23 mm)
Weight	approx. 70 g
Permissible ambient temperature range during operation	-25°C ... +60°C (extended temperature range)
Permissible ambient temperature range during storage	-40°C ... +85°C
Permissible relative humidity	95%, no condensation
<u>Mounting</u> [▶ 58]	on 35 mm mounting rail conforms to EN 60715
Vibration / shock resistance	conforms to EN 60068-2-6 / EN 60068-2-27
EMC immunity / emission	conforms to EN 61000-6-2 / EN 61000-6-4
Protection class	IP20
Installation position	Variable
Approvals / markings*	CE, UKCA, EAC, cULus [▶ 63], ATEX [▶ 59], IECEx [▶ 60]

\*) Real applicable approvals/markings see type plate on the side (product marking).

#### Ex markings

Standard	Marking
ATEX	II 3 G Ex nA IIC T4 Gc
IECEX	Ex nA IIC T4 Gc

## 2.4 Junctions with POF connection

### 2.4.1 EK1561

#### 2.4.1.1 Introduction

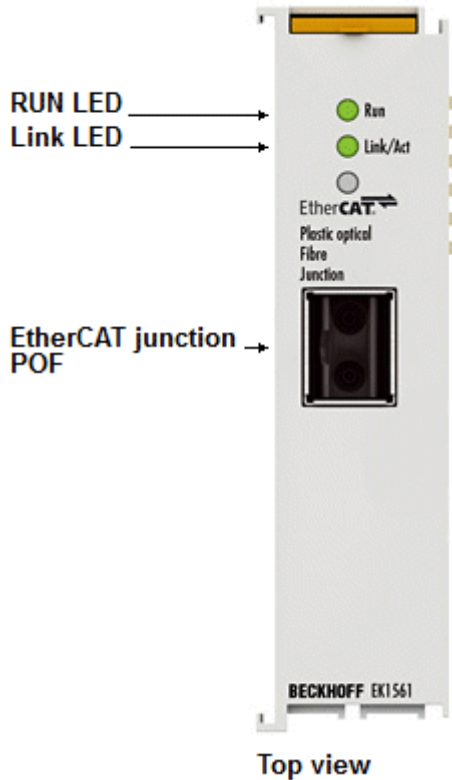

Fig. 19: EK1561

In connection with an EK1100 EtherCAT coupler, the EK1561 single-port POF junction makes it possible to convert from 100BASE-TX physics to 100BASE-FX physics (POF - Polymeric Optical Fiber). Distances of up to 50 m between two couplers can be bridged using the EK1561 and the EK1541 EtherCAT coupler for POF. Unlike the glass fiber, the POF fiber is easily wireable in the field. The Run LED indicates the status of the EK1561.

#### Connection

Terminal point	Description
Designation	
X1	Versatile Link connection for POF duplex connector (ZS1090-0008)

#### Quick links

- [EtherCAT basics](#)
- [Application notes \[▶ 47\]](#)
- [Diagnostic LEDs \[▶ 57\]](#)



**2.4.1.2 Technical data**

Technical data	EK1561
Task within the EtherCAT system	Coupling of EtherCAT junctions via POF
Cable length between two stations	max. 50 m (100BASE-FX) POF
Protocol	All EtherCAT protocols
Data transfer rates	100 Mbit/s
Delay	approx. 1 µs
Configuration	no address and configuration settings required

Optical Data	EK1561
Transmission medium	Polymeric Optical Fiber
Transceiver wavelength	650 nm Laser class 1, see note [► 92]
Bus connection	1 x versatile link for POF duplex connector (connector set ZS1090-0008)
Minimum output power (opt.)	NA = 0,5: -13,5 dBm
Min. necessary optical input power (sensitivity)	-26 dBm

General Data	EK1561
Power supply	from E-bus
E-Bus current consumption	typ. 200 mA
Dimensions (W x H x D)	approx. 26 mm x 100 mm x 52 mm (width aligned: 23 mm)
Weight	approx. 65 g
Permissible ambient temperature range during operation	-25°C ... +60°C (extended temperature range)
Permissible ambient temperature range during storage	-40°C ... +85°C
Permissible relative humidity	95%, no condensation
Mounting [► 58]	on 35 mm mounting rail conforms to EN 60715
Vibration / shock resistance	conforms to EN 60068-2-6 / EN 60068-2-27
EMC immunity / emission	conforms to EN 61000-6-2 / EN 61000-6-4
Protection class	IP20
Installation position	variable
Approvals / markings*	CE, UKCA, EAC, cULus [► 63]

\*) Real applicable approvals/markings see type plate on the side (product marking).

### 3 Commissioning/application notes

#### 3.1 Application notes RJ45 junction

##### 3.1.1 EK1121-0010 - Settings and port assignment

For normal operation the EK1121-0010 can be used with default settings.

The port ID used in the TwinCAT System Manager is mapped on the EK1121-0010 as follows:

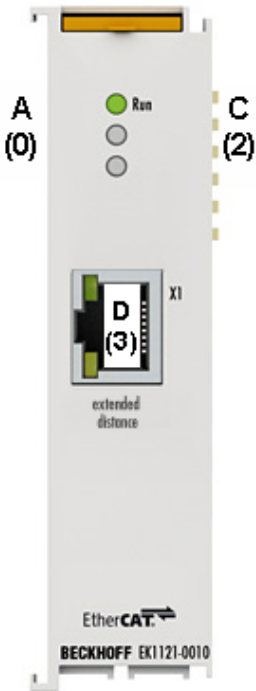

Fig. 20: EK1121-0010 port ID

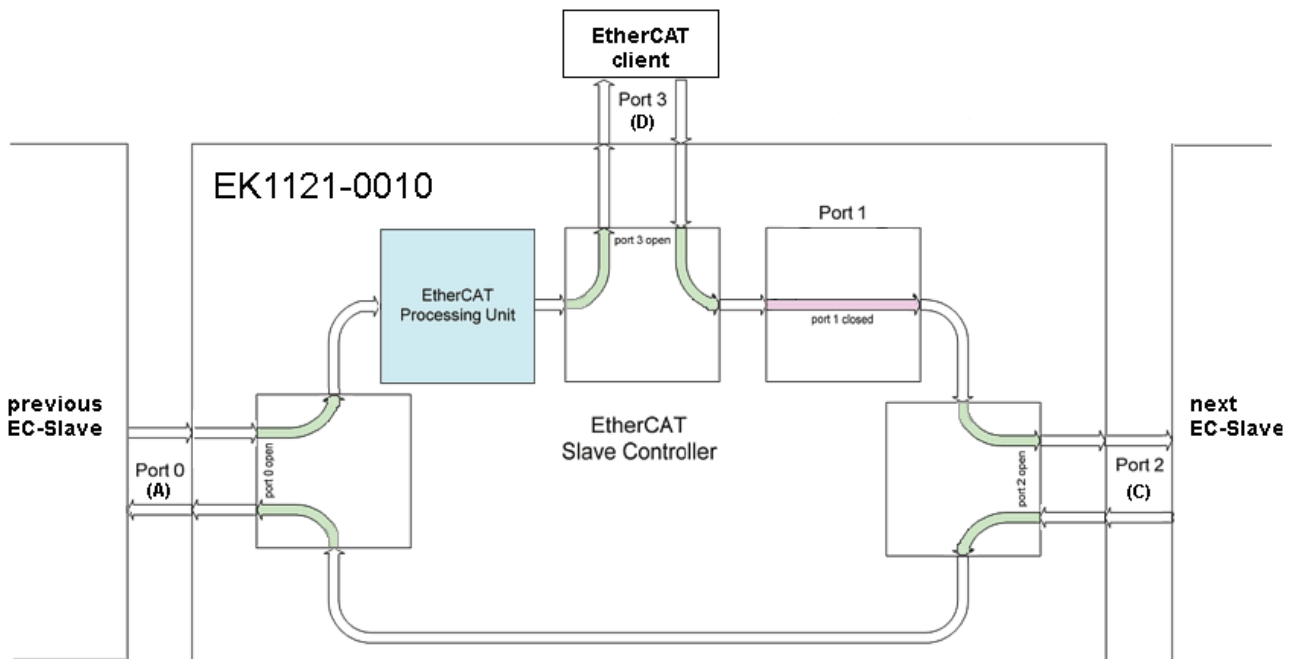

Fig. 21: Internal and external port assignment for EK1121-0010

### 3.1.2 EK1122 - Settings and port assignment

For normal operation the EK1122 can be used with default settings.

The port ID used in the TwinCAT System Manager is mapped on the EK1122 as follows:

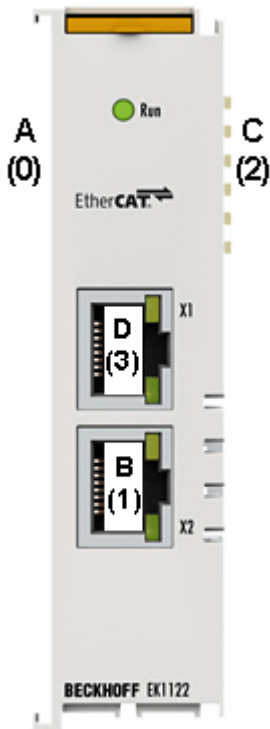

Fig. 22: EK1122 port ID

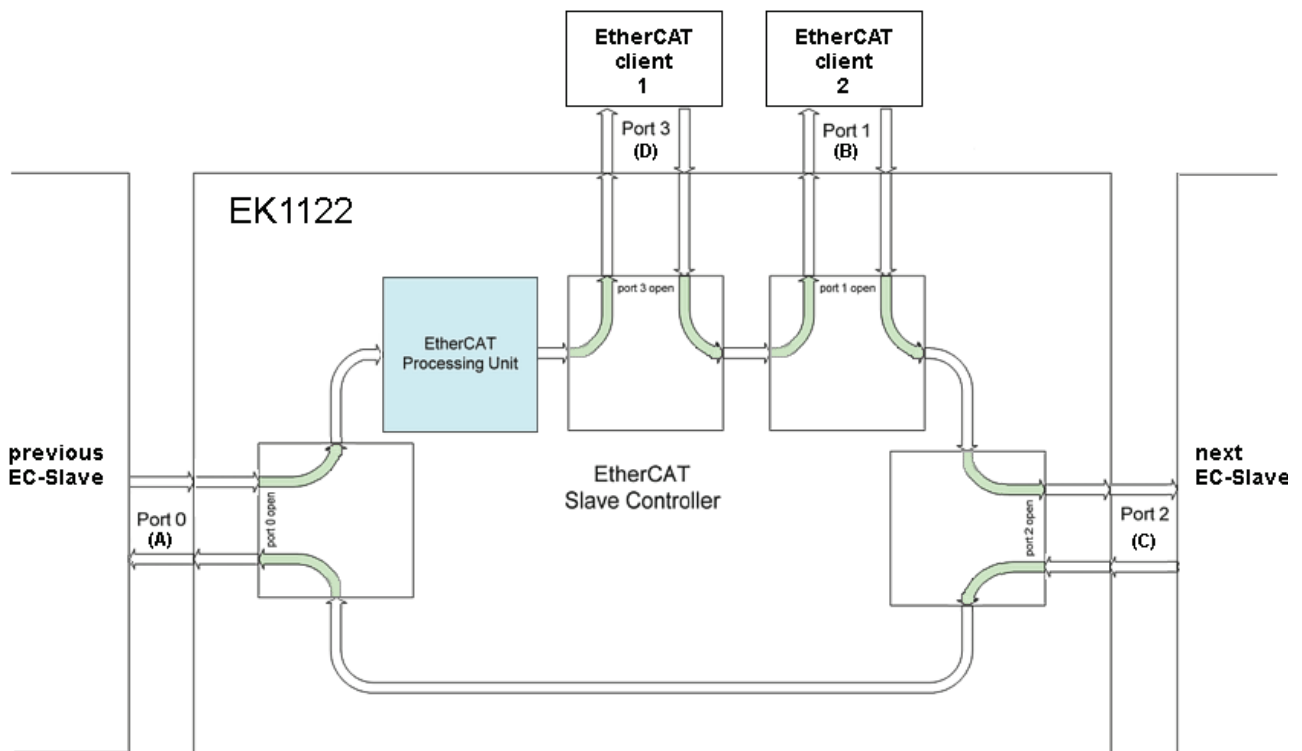

Fig. 23: Internal and external port assignment for EK1122

## 3.2 Application notes M8 junction

### 3.2.1 EK1122-0008 - Settings and port assignment

For normal operation no settings are required at the EK1122-0008.

The port ID used in the TwinCAT System Manager is mapped on the EK1122-0008 as follows:

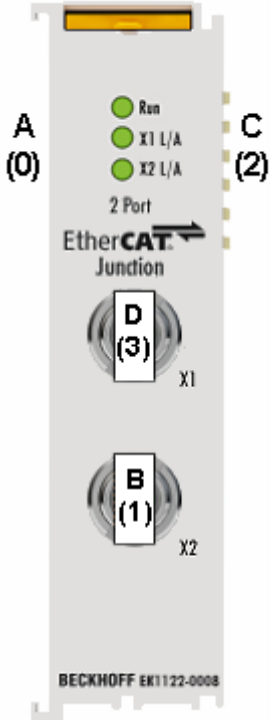

Fig. 24: Port ID for EK1122-0008

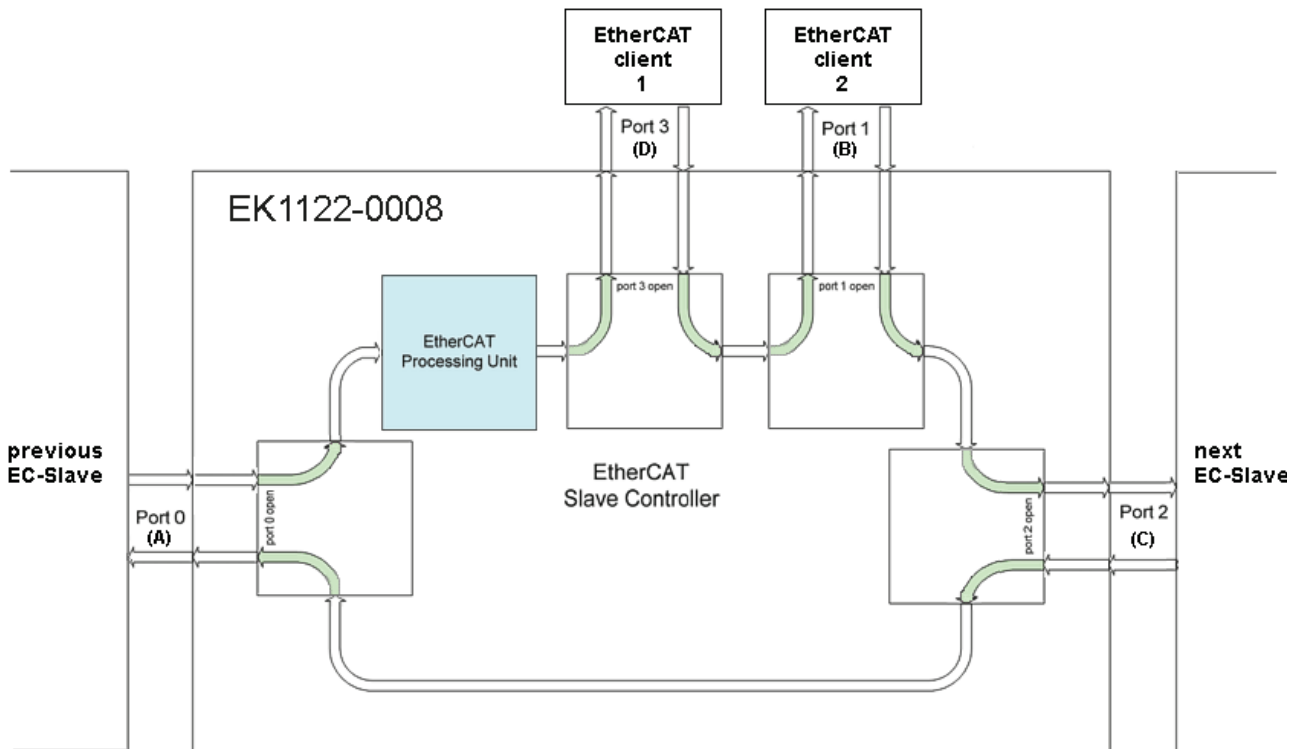

Fig. 25: Internal and external port assignment for EK1122-0008

### 3.3 Application notes fiber optic junction

#### Mounting rail installation

---



##### Mounting

Please ensure that the EK1521, EK1521-0010 engages properly on the DIN rail. See [mounting rail installation](#) [▶ 66].

---

### 3.3.1 Principles of fiber-optic technology

When using fiber-optic cables for the transmission of data, there are various factors that influence the signal transmission and have to be observed in order to guarantee reliable transmission. Important principles of fiber-optic technology are described below.

#### Attenuation

Less light reaches the end of a connection with fiber-optic cables than is input at the start of the connection. This loss of light between the start and end of the transmission link is called attenuation. The attenuation between two points is often stated in decibels (dB). However, the decibel is not a unit, but a ratio – in the case of a fiber-optic cable it is the ratio of the light energy at the start of the connection to that at the end. It is one tenth of a Bel (B) (1 B = 10 dB). In general, decibel indicates a power level  $L_p$  from the ratio of one power  $P_1$  to another power  $P_2$ .

- $L_p[\text{dB}] = 10 \cdot \log_{10}(P_1/P_2)$

A positive power factor is a signal amplification, a negative power factor conversely a weakening or attenuation of the signal.

The attenuation of a fiber-optic connection is essentially determined by three influencing factors. These influencing factors are the attenuation in the fiber-optic, the attenuation in the connector and the attenuations that result from the splices in the fiber-optic connection. The total attenuation is therefore given by

- Fiber-optic link attenuation [dB] = fiber loss attenuation [dB] + connector insertion attenuation [dB] + splice insertion attenuation [dB]

Where

- fiber loss attenuation [dB] = fiber attenuation coefficient [dB/km] x length [km]
- connector insertion attenuation [dB] = number of connectors x connector insertion attenuation [dB]
- splice insertion attenuation [dB] = number of splices x splice insertion attenuation [dB]

#### Dispersion

A further influence that needs to be observed with the signal transmission is the dispersion. Dispersion describes the spreading or widening of a light pulse. Due to propagation differences resulting in the fiber-optic cable from different injection angles of the light waves, the optical pulse widens and is therefore wider at the output than at the input. The longer the transmission link, the greater the dispersion.

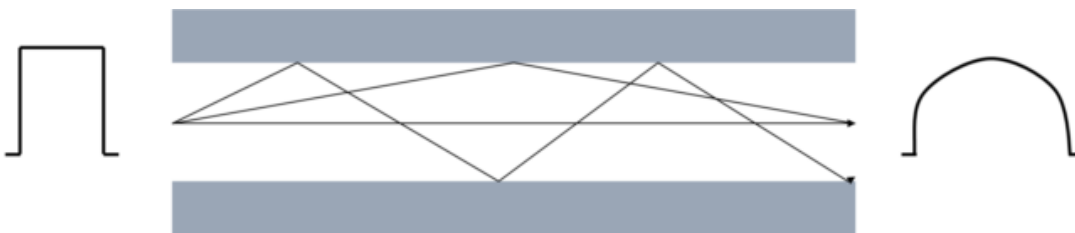

Fig. 26: Dispersion

If higher data rates are to be transmitted by the fiber-optic cable, the pulses must be sent faster at the input. What may happen then, however, is that pulses at the output run into one another and can no longer be distinguished from one another. The dispersion thus limits the maximum bandwidth of the fiber-optic connection.

The maximum bandwidth is specified in the data sheet for a fiber-optic cable as the bandwidth/length ratio in the unit MHz\*km. Therefore, the longer a transmission link, the smaller the available bandwidth. The bandwidth/length ratio or product is always specified in the data sheet for a fiber-optic cable. The length of the transmission link can then be calculated with the necessary bandwidth.

$$s [\text{km}] = \text{bandwidth} [\text{MHz}] / \text{bandwidth/length ratio} [\text{MHz/km}]$$

### Further influences on the signal transmission

In addition to the main influences (attenuation and dispersion) that limit the transmission link, care must be taken when installing and maintaining fiber-optic transmission links.

Sharp kinks and micro-bends in the fiber-optic lead to additional reflections in the fiber, as a result of which the influences of the attenuation and dispersion are increased. The specified bending radii of fiber-optic cables must be adhered to.

Poorly installed connectors also have a great influence on the signal quality. In case of poor connections, the fiber-optic may be too far away from the connecting piece, so that the light waves do not enter the fiber at the right angle of entry.

The third influence on the signal transmission that needs to be observed is soiling of, or damage to the ends of optical fibers. Due to the size of the fibers, often just 125 µm, dirt or damage cannot be discerned with the naked eye. Only a microscope with a sufficient magnification (at least factor 100) enables the fiber ends to be checked. To prevent soiling, the cable cap supplied with the cable should always be fitted to the fiber end.

### Power and attenuation budget

The power budget specifies the minimum power present between transmitter and receiver. The attenuation budget, conversely, describes the attenuation present between transmitter and receiver due to the three attenuation influences - fiber, connectors and splices - described above.

Transceivers (from the words transmitter and receiver) are installed in fiber-optic transmitters and/or receivers. This transceiver is a combined transmitting and receiving device. The data sheet for the transceiver contains two values that are necessary for the calculation of the power budget. These values are the **minimum output power** of the transmitter and the **maximum sensitivity** of the receiver. Therefore, the worst case, i.e. the lowest power between transmitter and receiver, is always considered. Both values are often specified in the unit decibel milliwatt (dBm). dBm describes a power level in relation to a reference value of 1 mW.

- $L_p[\text{dB}] = 10 \cdot \log_{10}(P_i/1 \text{ mW})$

0 dBm then corresponds to a power value of 1 mW, positive dBm values indicate power values >1 mW and negative dBm values indicate power values <1 mW.

The difference between the maximum output power and the minimum sensitivity at the input results in the power level.

- Power level = minimum output power - maximum sensitivity

The attenuation level results from the influences on the attenuation described above.

- Attenuation level [dB] = fiber loss attenuation [dB] + connector insertion attenuation [dB] + splice insertion attenuation [dB]

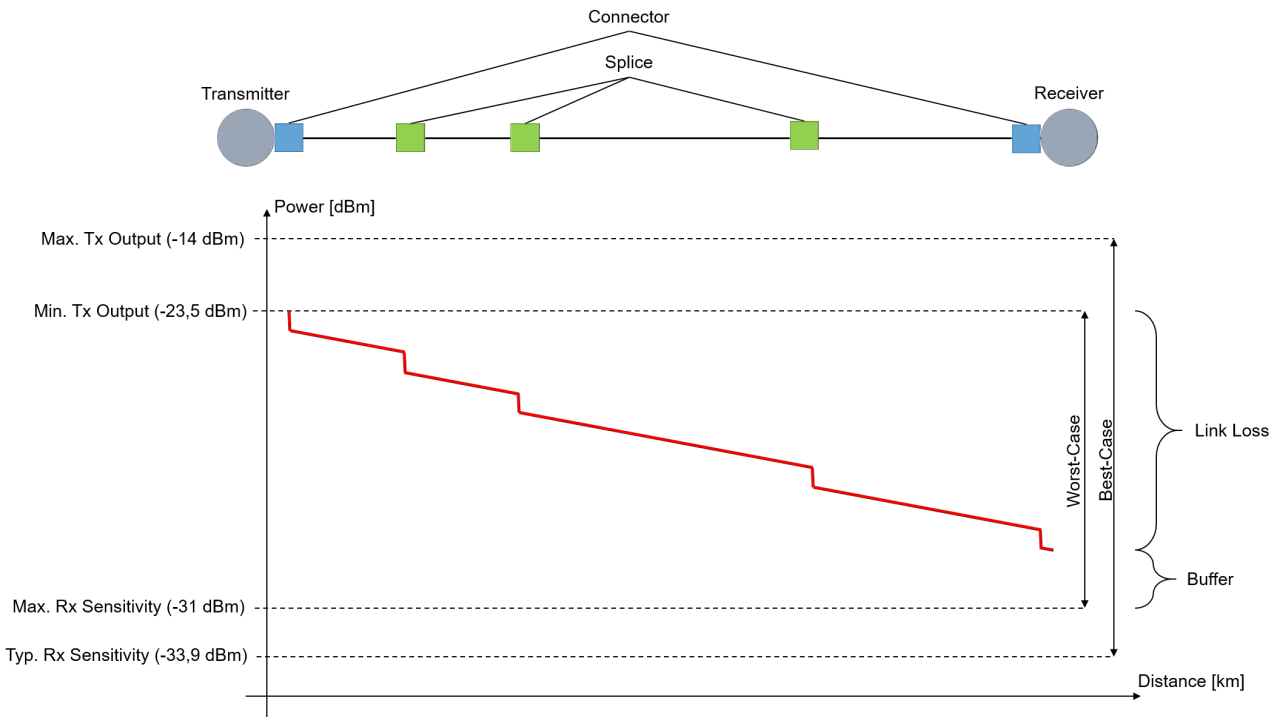

Fig. 27: Power and attenuation budget

The attenuation level must not exceed the power level. A power buffer of >3 dB is recommended so that long-term operation is possible over many years despite power losses. Sources located in the transmitter can age and lose power, connectors or splices can deteriorate, or connectors can become dirty if they are opened for diverting or testing. If cables are inadvertently cut through, excess play is required in order to accommodate splices for reconnecting.

**Example calculation of power and attenuation budget**

In an example calculation, the power and attenuation budget is to be calculated for a transmission link of 2.1 km in length between an EK1501 and an EK1521 with a multimode fiber in the strength 50/125 μm. The two fiber-optic couplers under consideration have the same transceiver. The optical data are given in the technical data for the EK1521.

First of all, the power budget existing between the two couplers must be calculated:

Power budget	
Parameter	Value
Minimum output power [50/125 μm]	-23.5 dBm
Maximum sensitivity	-31 dBm
<b>Power budget</b>	<b>7.5 dBm</b>

In the next step, the attenuation budget, i.e. the attenuation over the entire transmission link, must be calculated. A multimode fiber in the strength 50/125 μm from Beckhoff (ZK1091-1001-xxxx) is used for this example. A maximum attenuation of 0.8 dB/km at a wavelength of 1300 nm is specified in the data sheet for the fiber-optic cable. The cable is connected at both ends via an SC connector. The typical attenuation value of SC connectors is 0.25 dB, but it should nevertheless be checked for the specific application. Three splices were made over the entire link. A typical attenuation of 0.3 dB can be assumed per splice connection; however, the attenuation of a splice is dependent on its quality. The attenuation budget must be calculated from these values in the following.

Attenuation budget		
Parameter	Number	Value
Fiber loss attenuation (0.8 dB/km)	2.1 km	1.68 dB
Connector insertion attenuation (0.25 dB)	2	0.5 dB
Splice insertion attenuation (0.3 dB)	3	0.9 dB
<b>Attenuation budget</b>		<b>3.08 dB</b>



If the attenuation budget is now subtracted from the power budget, a power buffer of 4.42 dB results. This is greater than 3 dB and is therefore sufficient as a buffer for most applications, so that an additional splice or slight soiling of the fiber would not lead to failure of the data transmission.

If several values are given for a parameter in the data sheet for transceivers, cables or connectors, the worst value should always be taken and used for the calculation.

For the transmission link under consideration, the bandwidth/length ratio specified in the data sheet for the fiber should always be considered in addition to the attenuation and, as shown above, one should calculate whether the implementation of the length of the transmission link is possible with the desired bandwidth and the fiber.

## Evaluation of a fiber-optic transmission link by means of measurement

A fiber-optic transmission link can be described and evaluated with parameters from data sheets. In order to obtain a real result for the attenuation over the entire link, however, the link must be measured using an optical power meter (OPM). The power at the end of the transmission link can be measured with an OPM.

When measuring with an OPM, it is essential to ensure that only the required adapter (FC, SC, ...) is screwed to the OPM. If several adapters are screwed above one another to the OPM, the distance between the connector and the detector in the OPM is too large, with the result that lower power values are displayed (greater attenuation than actually exists).



OPM without adapter



OPM with FC adapter screwed on



OPM with SC adapter screwed on



OPM with FC and SC adapter screwed on - WRONG

### 3.3.2 EK1521-00x0 - Settings and port assignment

For normal operation the EK1521, EK1521-0010 can be used with default settings.

The port ID used in the TwinCAT System Manager is mapped on the EK1521, EK1521-0010 as follows:



Fig. 28: Port ID for EK1521, EK1521-0010

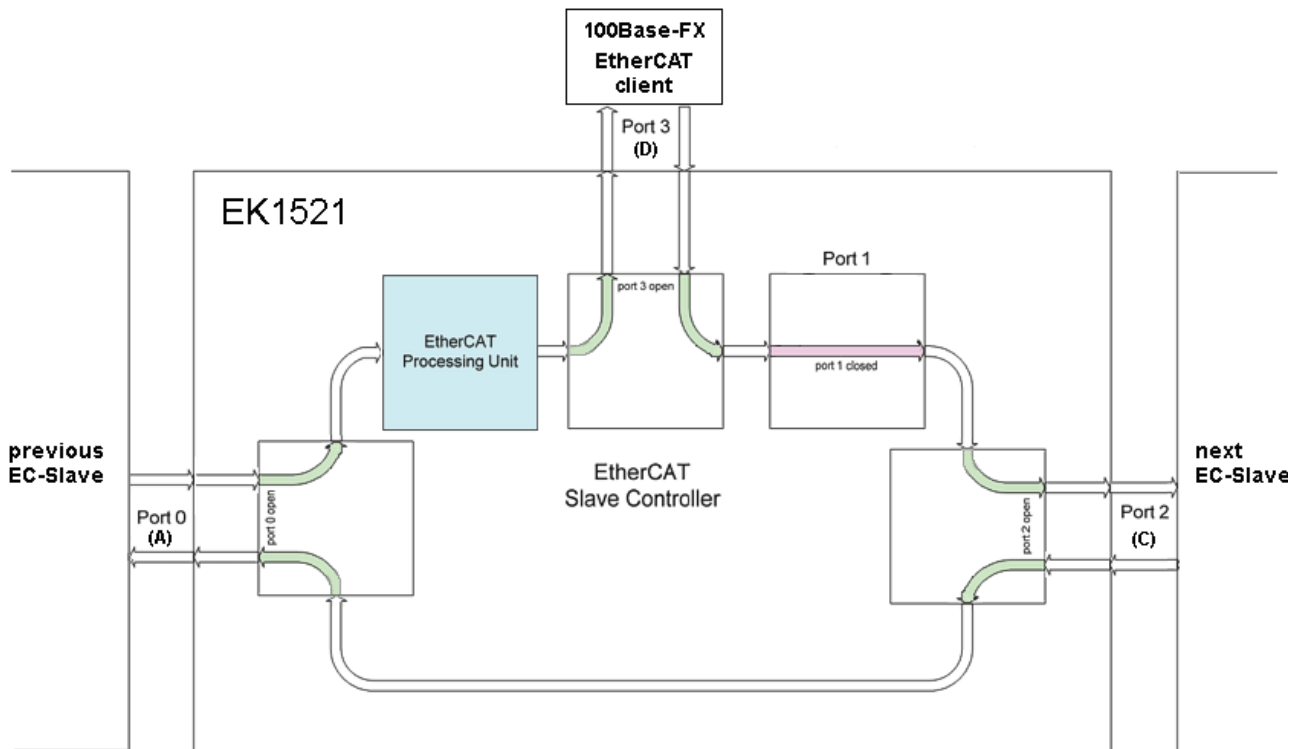

Fig. 29: Internal and external port assignment EK1521, EK1521-0010

### 3.3.3 Notes on suitable optical fiber cables

#### General information on optical fiber types

Optical fiber are available as multimode and single mode types with different step and graded indices.

#### Step and graded index

Optical fiber cables consist of 2 concentric materials, the core and cladding, plus a protective (colored) jacket. The core and the cladding have a different index of refraction, causing the light waves (modes; a mode is a natural wave in the optical fiber) to be reflected back into the core at the boundary. Due to the step change in the index of refraction this type of fiber is referred to as step index. A gradual/parabolic transition between the index of refraction in the core and the coating (referred to as graded index) can be achieved by mixing the materials. In a graded index fiber the modes are gradually diffracted back to the core, leading to propagation-time compensation and significantly higher quality of the light pulse at the outlet compared with a multimode step index fiber, where the different light modes have different signal run times (mode dispersion) with associated front distortion.

#### Single mode

Single-mode fibers have a very thin core (9  $\mu\text{m}$ ) and therefore conduct only a single mode of the light used, with high signal quality and virtually without mode dispersion. They are only available as step index fibers. Due to the high signal quality they are suitable for large transmission bandwidths  $> 10 \text{ GHz}\cdot\text{km}$  and distances  $> 50 \text{ km}$ . The refractive index profile of single-mode fibers is dimensioned such that the multipath propagation (intermodal dispersion), which is a problem with multi-mode fibers, is omitted – the signal light propagates in a single-mode fiber only in a single guided fiber mode, hence the designation 'single-mode'. This makes considerably larger transmission distances and/or bandwidths possible, and the limiting effect that arises next is the color distortion of the transmitted mode.

#### Multimode

Multimode fiber-optics are manufactured as step index or graded index. Step index multimode fiber cables are suitable for transmission bandwidths up to  $100 \text{ MHz}\cdot\text{km}$  and distances up to 1 km. Graded index multimode fiber cables with core diameters between 50 and 62.5  $\mu\text{m}$  reach transmission bandwidths  $> 1 \text{ GHz}\cdot\text{km}$  and ranges  $> 10 \text{ km}$ . Multimode means that the core of the fiber-optic cable is thick enough to enable several light modes to propagate reflectively in the cable.

There are different types of multimode fiber-optics, which are optimized for different wavelengths or transmission sources. Through the optimization of the fibers for different wavelengths, the attenuation differs with different transmission rates and the bandwidth/length ratio differs for the different fiber types. The exact values must be taken from the data sheet for the selected fiber in order to check whether the use of the selected fiber is wise.

- OM1: 62.5/125  $\mu\text{m}$ , optimized for 1300 nm LEDs
- OM2: 50/125  $\mu\text{m}$ , optimized for 1300 nm LEDs
- OM3: 50/125  $\mu\text{m}$ , optimized for 850 nm VCSEL (vertical-cavity surface-emitting laser)
- OM4: 50/125  $\mu\text{m}$ , optimized for 850 nm VCSEL (vertical-cavity surface-emitting laser)

### 3.3.4 Application with EK1521 and EK1521-0010

Application with EK1521 and EK1521-0010

The EK1521, EK1521-0010 is intended for application with optical fiber cables with the following characteristics:

- SC duplex connector
- EK1521: Duplex multimode 50/125  $\mu\text{m}$  or 62.5/125  $\mu\text{m}$  (inner/outer core diameter). The use of both diameters is possible. However, the use of 50/125  $\mu\text{m}$  is recommended due to the lower attenuation.
- EK1521-0010: Duplex single-mode 9/125  $\mu\text{m}$  (inner/outer core diameter). A typically usable cable can be manufactured according to the specification ITU-T G.652.D (0.4 dBm/km at 1300 nm).

---

#### ● Recommended connectors

**i** The use of SC/PC connectors is recommended for connecting to the EK1521, EK1521-0010. The advantage of the "PC" (physical contact) version of this connector is the crowned end face, which allows the region of the fiber core that is relevant to transmission to be optimally joined when the connector is pushed together. Other versions include, for instance, the SC/UPC (ultra-polish PC), SC/HRL (high return loss) and the SC/APC plug (angled physical contact). An additional feature of these connectors is that light that is reflected by the connector's end face, which is at an angle of about  $8^\circ$  to the fiber axis, is refracted from the core by the cladding glass into the air. This avoids interference with the data transmission, optimizing the core size of the back-scatter.

---

#### ● 50/125 $\mu\text{m}$ or 62.5/125 $\mu\text{m}$

**i** The use of both diameters is possible. However, the use of 50/125  $\mu\text{m}$  is recommended due to the lower attenuation.

In optical fibers the wavelengths 850 nm and 1300 nm are usually used for data transfer. Commercially available fiber-optic cables are usually optimized for application in one of these ranges, since signal attenuation is frequency-dependent (like in copper cable), so that large ranges of several km can be achieved for the respective wavelength. Fiber-optic cables in the 1300 nm window generally have lower attenuation than cables in the 850 nm window.

In the EK1521, EK1521-0010 a transceiver with the wavelength of 1300 nm is used.

---

#### ● Range and bandwidth product

**i** Optical fiber cables are available in different qualities from reputable manufacturers. One of the relevant parameters for the user is the frequency-dependent bandwidth product of a cable, specified in [MHz\*km]. The greater the bandwidth product, the lower the attenuation, and therefore the larger the range that can be achieved with this cable (see ITU-T G-651). For achieving the maximum range with the EK1521, EK1521-0010, optical fibers with a maximum bandwidth product of 1300 nm should therefore be used; we recommended using class OM2 optical fibers (EN50173:2002). Standard optical fiber cables have a minimum bandwidth product of 500 MHz\*km at 1300 nm, higher-quality cables are suitable for distances > 500 m over > 1000 MHz\*km. In order to achieve the maximum range, the device to which the EK1521, EK1521-0010 is connected must also support such ranges.

---

#### ● Installation notes

**i**

- permitted bending radius
- permitted tensile strength
- sensitivity of the exposed contact ends

Further information can be found in the following documents:

- ITU recommendation ITU-T G.651 - G.655
- EN 50173:2002
- EN 60793-2

**Connecting and releasing the optical fiber cable at the junction****NOTICE****Risk of damage to the cable!**

To disconnect the optical fiber cable always pull the connector to release the locking mechanism - never pull the optical fiber cable itself.

**● Crossover cables**

**i** Not that crossover cables may have to be used for connecting the EK1521, EK1521-0010 with the EK1501/ EK1501-0010.

**Practical tip:**

In many cases the infrared light emission can be made visible via a digital or smartphone camera at the junction or at the coupler (see figure). Avoid 'light meeting light' when connecting the optical fiber cable (Tx → Tx). In this case no connection can be established, and crossover cables must be used (Tx → Rx).



Figure: Visualization of infrared light at the SC duplex connector

**● Use of blind plugs**

**i** To protect the transceiver from environmental influences, unused connection socket should be sealed with the blind plugs provided!



Figure: Blind plugs in unused sockets

### 3.4 Application notes POF junction

#### Mounting rail installation

**i** **Mounting**

Please ensure that the EK1561 engages properly on the DIN rail. See [mounting rail installation](#) [▶ 66].

#### 3.4.1 EK1561 - Settings and port assignment

For normal operation the EK1561 can be used with default settings. The port ID used in the TwinCAT System Manager is mapped on the EK1561 as follows:



Fig. 30: EK1561 port ID

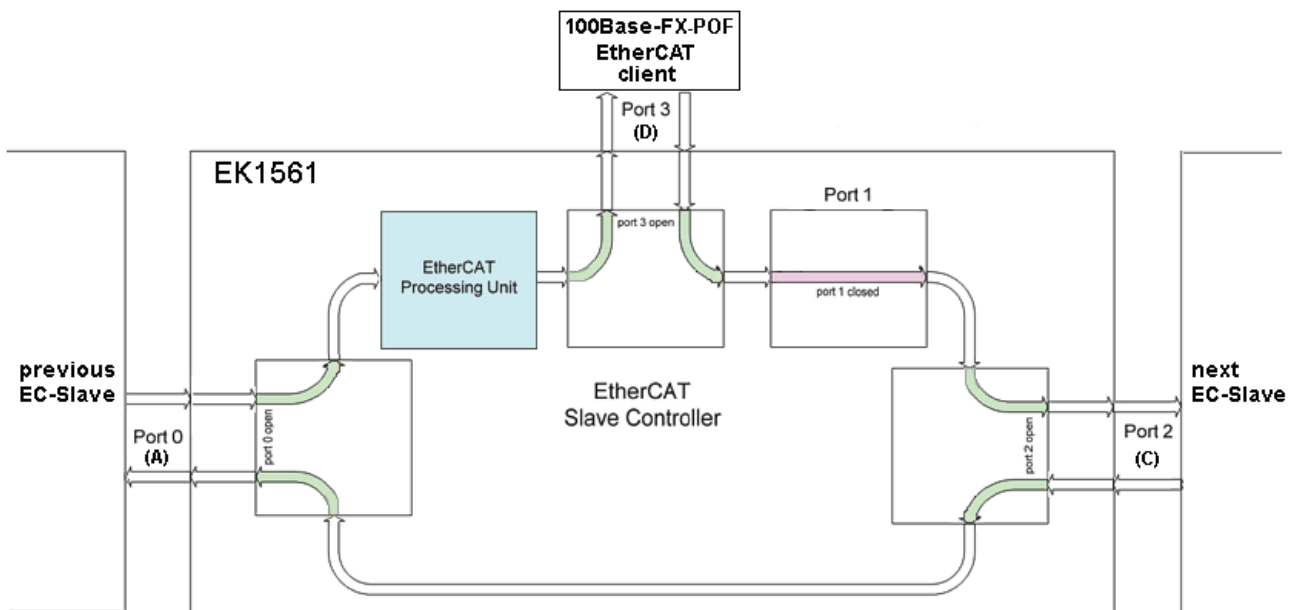

Fig. 31: Internal and external port assignment for EK1561

### 3.4.2 Notes regarding suitable POF cables

#### General information about POF cables

The standard polymer fiber is 1 mm thick and consists of a 0.98 mm thick core made of polymethyl methacrylate (PMMA) as well as a thin sheath. In order to enable the guidance of light using the effect of total reflection in the core, the usually very thin sheath consists of fluorinated PMMA, which has a low refractive index. The core diameters lie between 0.06 and 1 mm, as a result of which simple plug connections are easy to implement. Furthermore, the splicing process often used for the connection of glass fibers and the unnecessarily high expenditure associated with it can usually be dispensed with. The maximum operating temperature of standard POF is approximately 60 °C and has a refraction profile with step index (SI-POF). The refractive index of the core material is around 1.49 and that of the sheath around 1.41. The difference determines the numerical aperture (NA) and thus the maximum propagation angle. With a difference of 5% this angle is about 20 degrees in relation to the fiber axis, which leads to a reduction in the bandwidth.

Due to the simple and almost universally applicable connection techniques compared to glass fibers, POFs are used in particular for short transmission distances, such as inside rooms, technical equipment, mechanical systems or cars.

POFs have an attenuation of about 140 dB/km at a wavelength of 650 Nm, so that a maximum data transmission distance of 50 m can be achieved when used with the EK1561.

Insertion of additional connectors in the route increases the signal attenuation. For each additional connector, the maximum permitted distances typically reduces by 6.5 m.



### 3.4.3 Application with EK1561

#### ● Recommended connectors and POF cables

**i** For the connection of the EK1561 it is recommended to use the connector set [ZS1090-0008 \[▶ 51\]](#) (Versatile Link Duplex connectors) in conjunction with a duplex polymer fiber with an outside diameter of 2 x 2.2 mm (Z1190), which are available from Beckhoff.

#### ● Installation notes

- i**
- permissible bending radius (in general  $r \geq 25$  mm, refer to the manufacturer's data!)
  - permitted tensile strength
  - sensitivity of the exposed contact ends

#### Connecting and releasing the POF cable at the junction

To connect the cable, insert the plug (available as an accessory in the plug set ZS1090-0008) into the connection opening until it audibly latches.

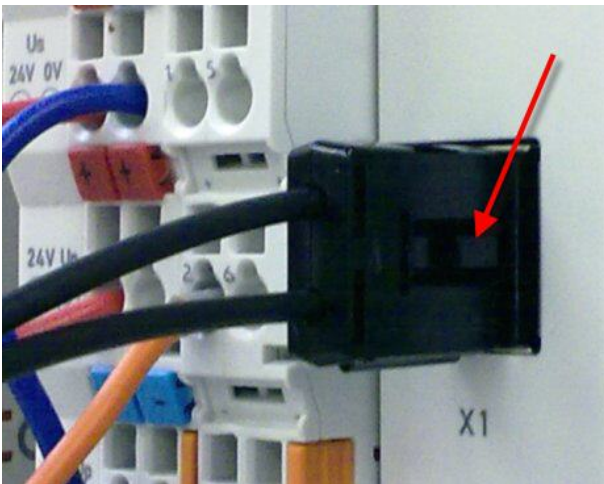

Fig. 32: Latching lug with release catch on the POF duplex plug

To release the connector activate the release device with the latching lug. This is located on the right-hand side of the connector (see Fig. "Latching lug with release catch at the POF duplex connector")

#### NOTICE

##### **Risk of damage to the cable!**

To release the cable, press the release catch on the plug and pull the plug at the same time – never pull by the POF cable alone!

**NOTICE****TX / Rx channel assignment**

During cable assembly [[▶ 51](#)] note the assignment of the optical channels in the connection socket. In the EK1561, the light-emitting transmitter channel (Tx) is the upper outlet in the connection socket.



Figure: Transmitter channel in the EK1561

Be sure to observe the safety instructions [[▶ 92](#)] for class 1 lasers!

**NOTICE****Use of blind plugs**

In order to avoid accidents due to glare (Class 1 laser, please observe the safety instructions [[▶ 92](#)]) and to protect the transceiver against environmental influences, unused sockets should be sealed using the blind plugs provided!



Figure: Blind plugs in unused sockets

### 3.5 Notes regarding assembly of POF cables with the connector set ZS1090-0008



Fig. 33: Duplex connector set ZS1090-0008

The duplex connector set ZS1090-0008 from Beckhoff consists of 10 duplex Versatile Link connectors and several sheets of abrasive paper and polishing paper.

#### Step-by-step instructions for assembling the POF cable

The following step-by-step guide describes the correct assembly of a POF cable with a Versatile Link duplex connector. The connectors are attached to the cable ends with standard tools such as cutter knife or wire strippers. Polish the assembled cable with the polishing set provided with the connector set, consisting of a plastic sanding gauge, sheets of abrasive paper with grain size 600 and pink polishing sheets. Once assembled, the connector can be used right away.

Materials required:

1. POF cable (Polymeric Optical Fiber, e.g. Z1190 from Beckhoff)
2. Cutter knife or shears
3. Wire strippers
4. Polishing set (included with connector set ZS1090-0008 from Beckhoff)
5. Versatile Link duplex connector (included in connector set ZS1090-0008 from Beckhoff)

#### 1. Stripping the POF cable

The cable should be split over a length between 100 mm and 150 mm from the cable end, so that the following steps can be carried out properly.

Once you have shortened the cable to the required length, use the wire strippers to remove approx. 7 mm of the external sheathing of the individual wires. The two cable ends should be stripped over approximately the same length.

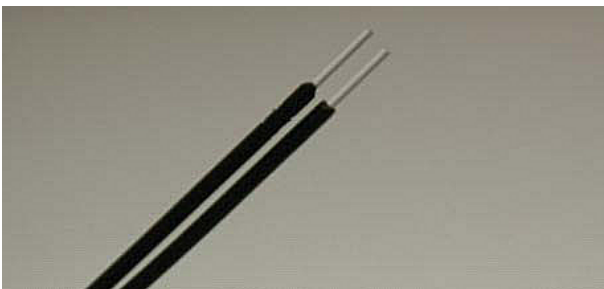

Fig. 34: POF cable stripped over the same length

## 2. Attaching the connector

Push the two cable ends into the connector and the connector back until it stops. The fibers should now protrude no more than 1.5 mm from the front openings.

Close the connector by folding the upper and lower halves together until they engage.

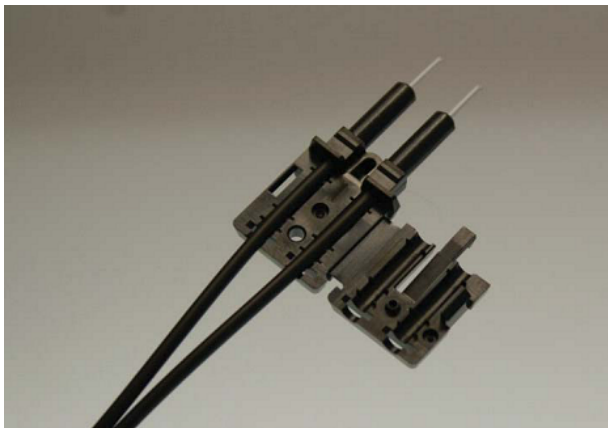

Fig. 35: Cable inserted in the connector

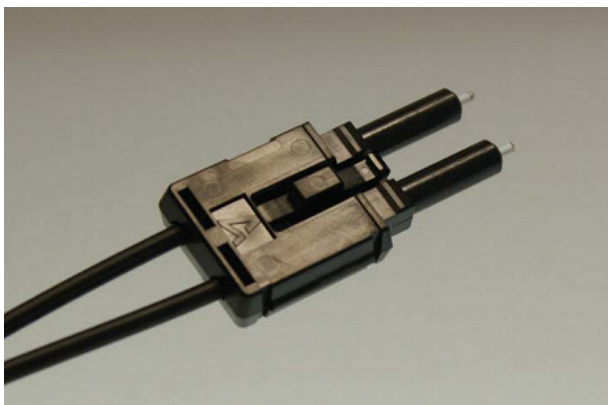

Fig. 36: Closed connector

When inserting the wires into the connector ensure the optical channels are crossed (Tx1 → Rx2; Tx2 → Rx1). The 'nose' at the connector hinge can be used as a guide.

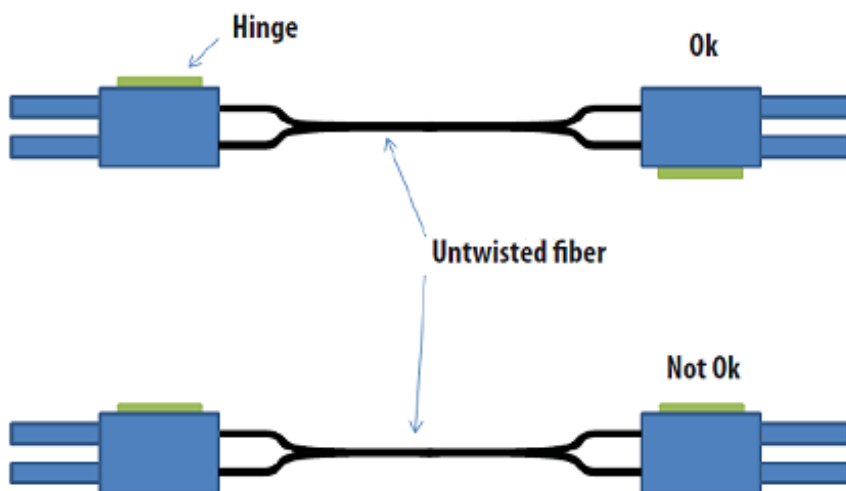

Fig. 37: Correctly connected optical channels

### 3. Grinding and polishing

Any fibers protruding more than 1.5 mm from the connector should be shortened with a cutter knife or a pair of scissors.

Now push the connector fully into the sanding gauge, so that the ends to be polished protrude from the lower side. The sanding gauge is suitable for polishing one or two simplex connectors or a duplex connector.

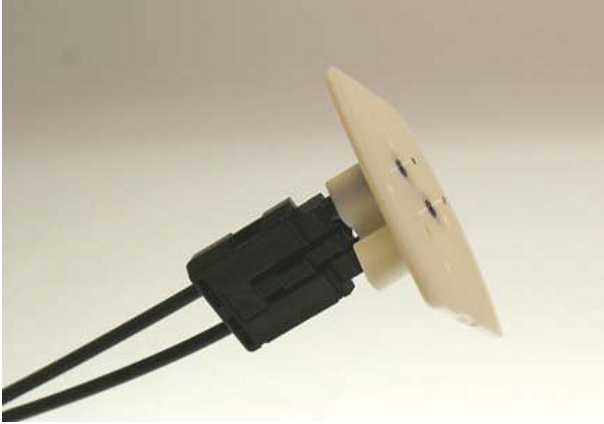

Fig. 38: Sanding gauge with protruding fiber ends

---

#### ● Wear indicator

**i** The wear indicator of the sanding gauge consists of four points on the underside. The sanding gauge should be replaced when one of these points is no longer visible.

---

Now press the sanding gauge onto the abrasive paper with uniform pressure and as perpendicular as possible. In order to achieve a uniform result, use the abrasive paper in the form of a figure of 8, until the fibers are flush with the sanding gauge. Then clean the sanding gauge and the connector from below with a soft, dry cloth.

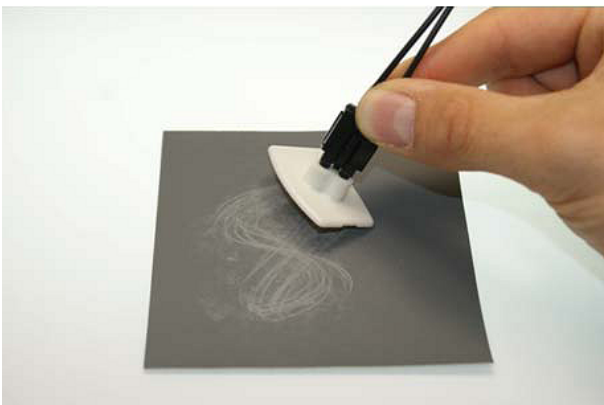

Fig. 39: Polishing in the form of a figure of 8

### 4. Fine polishing

Now use the pink polishing sheet for fine polishing in the same manner. Apply the connector with the sanding gauge to the matt side of the polishing sheet with slight pressure and polish in the form of a figure of 8 up to 25 times. After the procedure the fiber end should be flat, smooth and clean.

---

#### ● Improving the transfer performance by fine polishing

**i** Fine polishing with a polishing sheet can improve the transfer performance between the transmitter and the receiver or in the cable joint by up to 0.5 dB compared with to treatment with abrasive paper alone. For short transfer distances the polishing step can be omitted.

---

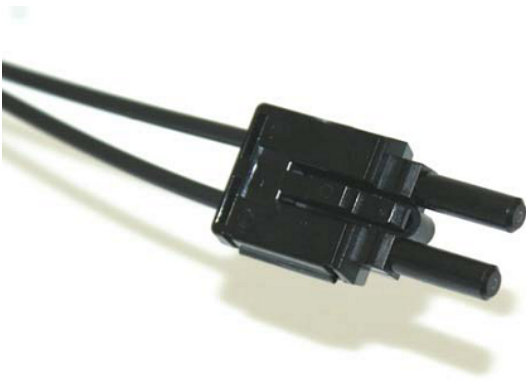

Fig. 40: Fine-polished fibers in the connector

## 4 Error handling and diagnostics

### 4.1 Diagnostic LEDs EK1121-0010, EK1122, EK1122-0008

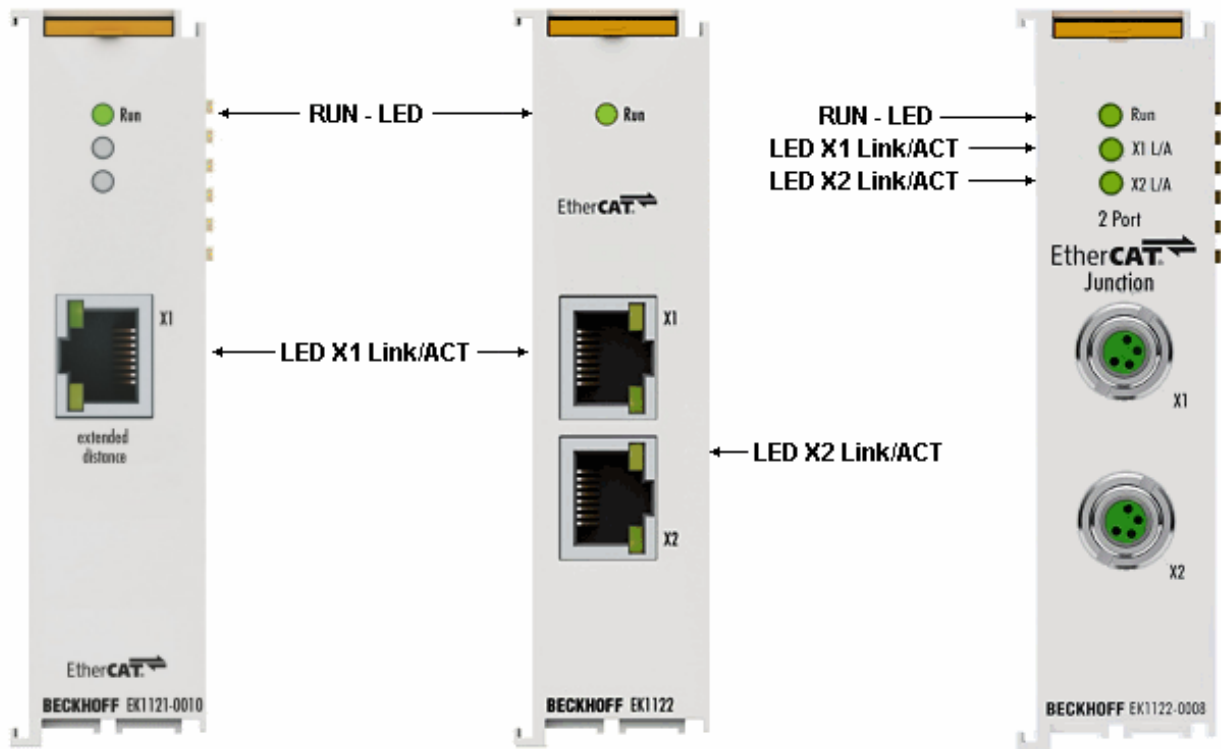

Fig. 41: EK1121-0010, EK1122, EK1122-0008, LEDs

#### LEDs for fieldbus diagnostics

LED	Display	State	Description	
LINK / ACT (X1/X2)	green	off	-	no connection on the EtherCAT strand
		on	linked	EtherCAT device connected
		flashing	active	Communication with EtherCAT device

#### LED diagnostics EtherCAT state machine

LED	Color	Meaning	
RUN	green	This LED indicates the terminal's operating state:	
		off	State of the EtherCAT State Machine: <b>INIT</b> = initialization of the terminal
		single flash	State of the EtherCAT State Machine: <b>PREOP</b> = function for mailbox communication and different standard-settings set
		flashing	State of the EtherCAT State Machine: <b>SAFEOP</b> = verification of the sync manager channels and the distributed clocks. Outputs remain in safe state
		on	State of the EtherCAT State Machine: <b>OP</b> = normal operating state; mailbox and process data communication is possible
		flickering	State of the EtherCAT State Machine: <b>BOOTSTRAP</b> = function for terminal firmware updates

## 4.2 Diagnostic LEDs EK1521, EK1521-0010

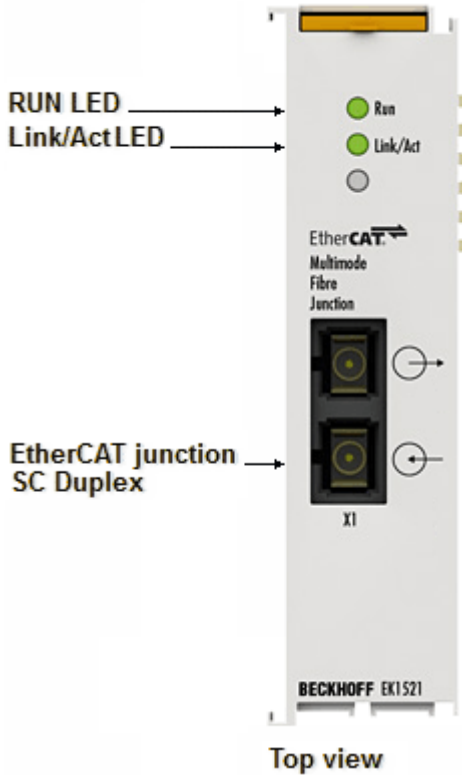

Fig. 42: EK1521 LEDs

### LEDs for fieldbus diagnostics

LED	Display	State	Description	
LINK / ACT (X1)	green	off	-	no connection on the EtherCAT strand
		on	linked	EtherCAT device connected
		flashing	active	Communication with EtherCAT device

### LED diagnostics EtherCAT state machine

LED	Color	Meaning	
RUN	green	This LED indicates the terminal's operating state:	
		off	State of the EtherCAT State Machine: <b>INIT</b> = initialization of the terminal
		single flash	State of the EtherCAT State Machine: <b>PREOP</b> = function for mailbox communication and different standard-settings set
		flashing	State of the EtherCAT State Machine: <b>SAFEOP</b> = verification of the sync manager channels and the distributed clocks. Outputs remain in safe state
		on	State of the EtherCAT State Machine: <b>OP</b> = normal operating state; mailbox and process data communication is possible
		flickering	State of the EtherCAT State Machine: <b>BOOTSTRAP</b> = function for terminal firmware updates



### 4.3 Diagnostic LEDs EK1561

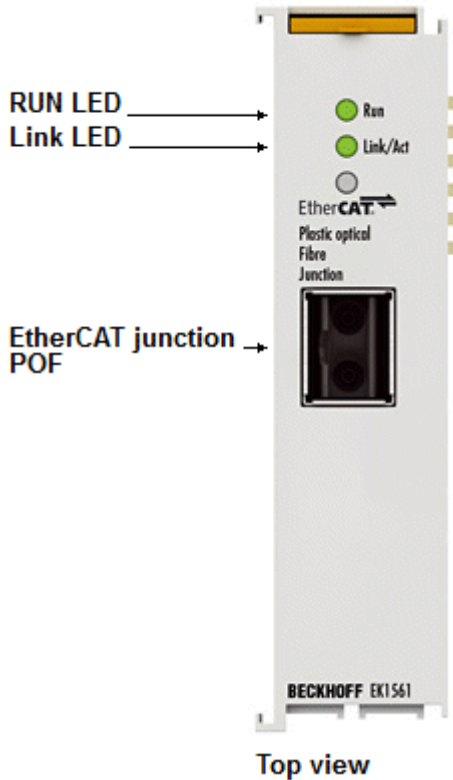

Fig. 43: EK1561 LEDs

#### LEDs for fieldbus diagnostics

LED	Color	Display	State	Description
LINK / ACT (X1)	green	off	-	no connection on the EtherCAT strand
		on	linked	EtherCAT device connected
		flashing	active	Communication with EtherCAT device

#### LED diagnostics EtherCAT state machine

LED	Color	Meaning	
RUN	green	This LED indicates the terminal's operating state:	
		off	State of the EtherCAT State Machine: <b>INIT</b> = initialization of the terminal
		single flash	State of the EtherCAT State Machine: <b>PREOP</b> = function for mailbox communication and different standard-settings set
		flashing	State of the EtherCAT State Machine: <b>SAFEOP</b> = verification of the sync manager channels and the distributed clocks. Outputs remain in safe state
		on	State of the EtherCAT State Machine: <b>OP</b> = normal operating state; mailbox and process data communication is possible
		flickering	State of the EtherCAT State Machine: <b>BOOTSTRAP</b> = function for terminal firmware updates

## 5 Mounting and wiring

### 5.1 Instructions for ESD protection

#### NOTICE

##### **Destruction of the devices by electrostatic discharge possible!**

The devices contain components at risk from electrostatic discharge caused by improper handling.

- Please ensure you are electrostatically discharged and avoid touching the contacts of the device directly.
- Avoid contact with highly insulating materials (synthetic fibers, plastic film etc.).
- Surroundings (working place, packaging and personnel) should be grounded probably, when handling with the devices.
- Each assembly must be terminated at the right hand end with an [EL9011](#) or [EL9012](#) bus end cap, to ensure the protection class and ESD protection.

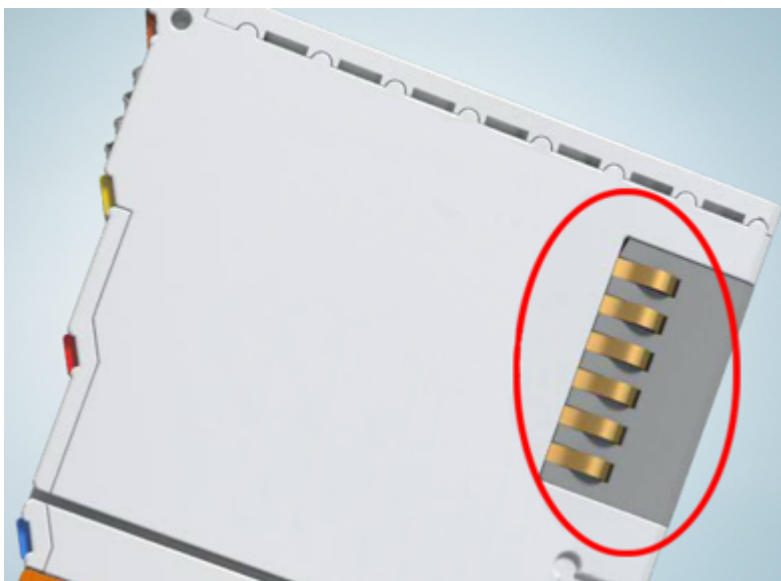

Fig. 44: Spring contacts of the Beckhoff I/O components

## 5.2 Explosion protection

### 5.2.1 ATEX - Special conditions (extended temperature range)

**⚠ WARNING**

**Observe the special conditions for the intended use of Beckhoff fieldbus components with extended temperature range (ET) in potentially explosive areas (directive 2014/34/EU)!**

- The certified components are to be installed in a suitable housing that guarantees a protection class of at least IP54 in accordance with EN 60079-15! The environmental conditions during use are thereby to be taken into account!
- For dust (only the fieldbus components of certificate no. KEMA 10ATEX0075 X Issue 9): The equipment shall be installed in a suitable enclosure providing a degree of protection of IP54 according to EN 60079-31 for group IIIA or IIIB and IP6X for group IIIC, taking into account the environmental conditions under which the equipment is used!
- If the temperatures during rated operation are higher than 70°C at the feed-in points of cables, lines or pipes, or higher than 80°C at the wire branching points, then cables must be selected whose temperature data correspond to the actual measured temperature values!
- Observe the permissible ambient temperature range of -25 to 60°C for the use of Beckhoff fieldbus components with extended temperature range (ET) in potentially explosive areas!
- Measures must be taken to protect against the rated operating voltage being exceeded by more than 40% due to short-term interference voltages!
- The individual terminals may only be unplugged or removed from the Bus Terminal system if the supply voltage has been switched off or if a non-explosive atmosphere is ensured!
- The connections of the certified components may only be connected or disconnected if the supply voltage has been switched off or if a non-explosive atmosphere is ensured!
- The fuses of the KL92xx/EL92xx power feed terminals may only be exchanged if the supply voltage has been switched off or if a non-explosive atmosphere is ensured!
- Address selectors and ID switches may only be adjusted if the supply voltage has been switched off or if a non-explosive atmosphere is ensured!

#### Standards

The fundamental health and safety requirements are fulfilled by compliance with the following standards:

- EN 60079-0:2012+A11:2013
- EN 60079-15:2010
- EN 60079-31:2013 (only for certificate no. KEMA 10ATEX0075 X Issue 9)

#### Marking

The Beckhoff fieldbus components with extended temperature range (ET) certified according to the ATEX directive for potentially explosive areas bear the following marking:



**II 3G KEMA 10ATEX0075 X Ex nA IIC T4 Gc Ta: -25 ... +60°C**  
 II 3D KEMA 10ATEX0075 X Ex tc IIIC T135°C Dc Ta: -25 ... +60°C  
 (only for fieldbus components of certificate no. KEMA 10ATEX0075 X Issue 9)

or



**II 3G KEMA 10ATEX0075 X Ex nA nC IIC T4 Gc Ta: -25 ... +60°C**  
 II 3D KEMA 10ATEX0075 X Ex tc IIIC T135°C Dc Ta: -25 ... +60°C  
 (only for fieldbus components of certificate no. KEMA 10ATEX0075 X Issue 9)

## 5.2.2 IECEx - Special conditions

### WARNING

#### Observe the special conditions for the intended use of Beckhoff fieldbus components in potentially explosive areas!

- For gas: The equipment shall be installed in a suitable enclosure providing a degree of protection of IP54 according to IEC 60079-15, taking into account the environmental conditions under which the equipment is used!
- For dust (only the fieldbus components of certificate no. IECEx DEK 16.0078X Issue 3): The equipment shall be installed in a suitable enclosure providing a degree of protection of IP54 according to EN 60079-31 for group IIIA or IIIB and IP6X for group IIIC, taking into account the environmental conditions under which the equipment is used!
- The equipment shall only be used in an area of at least pollution degree 2, as defined in IEC 60664-1!
- Provisions shall be made to prevent the rated voltage from being exceeded by transient disturbances of more than 119 V!
- If the temperatures during rated operation are higher than 70°C at the feed-in points of cables, lines or pipes, or higher than 80°C at the wire branching points, then cables must be selected whose temperature data correspond to the actual measured temperature values!
- Observe the permissible ambient temperature range for the use of Beckhoff fieldbus components in potentially explosive areas!
- The individual terminals may only be unplugged or removed from the Bus Terminal system if the supply voltage has been switched off or if a non-explosive atmosphere is ensured!
- The connections of the certified components may only be connected or disconnected if the supply voltage has been switched off or if a non-explosive atmosphere is ensured!
- Address selectors and ID switches may only be adjusted if the supply voltage has been switched off or if a non-explosive atmosphere is ensured!
- The front hatch of certified units may only be opened if the supply voltage has been switched off or a non-explosive atmosphere is ensured!

### Standards

The fundamental health and safety requirements are fulfilled by compliance with the following standards:

- EN 60079-0:2011
- EN 60079-15:2010
- EN 60079-31:2013 (only for certificate no. IECEx DEK 16.0078X Issue 3)

### Marking

Beckhoff fieldbus components that are certified in accordance with IECEx for use in areas subject to an explosion hazard bear the following markings:

Marking for fieldbus components of certificate no. IECEx DEK 16.0078X Issue 3:

**IECEx DEK 16.0078 X**  
**Ex nA IIC T4 Gc**  
**Ex tc IIIC T135°C Dc**

Marking for fieldbus components of certificates with later issues:

**IECEx DEK 16.0078 X**  
**Ex nA IIC T4 Gc**

### 5.2.3 Continulative documentation for ATEX and IECEx

#### NOTICE



#### Continulative documentation about explosion protection according to ATEX and IECEx

Pay also attention to the continuative documentation

#### **Ex. Protection for Terminal Systems**

Notes on the use of the Beckhoff terminal systems in hazardous areas according to ATEX and IECEx,

that is available for [download](#) within the download area of your product on the Beckhoff homepage [www.beckhoff.com](http://www.beckhoff.com)!

## 5.2.4 cFMus - Special conditions

### WARNING

**Observe the special conditions for the intended use of Beckhoff fieldbus components in potentially explosive areas!**

- The equipment shall be installed within an enclosure that provides a minimum ingress protection of IP54 in accordance with ANSI/UL 60079-0 (US) or CSA C22.2 No. 60079-0 (Canada).
- The equipment shall only be used in an area of at least pollution degree 2, as defined in IEC 60664-1.
- Transient protection shall be provided that is set at a level not exceeding 140% of the peak rated voltage value at the supply terminals to the equipment.
- The circuits shall be limited to overvoltage Category II as defined in IEC 60664-1.
- The Fieldbus Components may only be removed or inserted when the system supply and the field supply are switched off, or when the location is known to be non-hazardous.
- The Fieldbus Components may only be disconnected or connected when the system supply is switched off, or when the location is known to be non-hazardous.

### Standards

The fundamental health and safety requirements are fulfilled by compliance with the following standards:

M20US0111X (US):

- FM Class 3600:2018
- FM Class 3611:2018
- FM Class 3810:2018
- ANSI/UL 121201:2019
- ANSI/ISA 61010-1:2012
- ANSI/UL 60079-0:2020
- ANSI/UL 60079-7:2017

FM20CA0053X (Canada):

- CAN/CSA C22.2 No. 213-17:2017
- CSA C22.2 No. 60079-0:2019
- CAN/CSA C22.2 No. 60079-7:2016
- CAN/CSA C22.2 No.61010-1:2012

### Marking

Beckhoff fieldbus components that are certified in accordance with cFMus for use in areas subject to an explosion hazard bear the following markings:

FM20US0111X (US):                    **Class I, Division 2, Groups A, B, C, D**

**Class I, Zone 2, AEx ec IIC T4 Gc**



FM20CA0053X (Canada):           **Class I, Division 2, Groups A, B, C, D**

**Ex ec T4 Gc**

### 5.2.5 Continulative documentation for cFMus

<b>NOTICE</b>	
	<p><b>Continulative documentation about explosion protection according to cFMus</b>                      Pay also attention to the continuative documentation  <b>Control Drawing I/O, CX, CPX</b>                      Connection diagrams and Ex markings,                      that is available for <a href="#">download</a> within the download area of your product on the Beckhoff homepage <a href="http://www.beckhoff.com">www.beckhoff.com</a>!</p>

### 5.3 UL notice

<b>⚠ CAUTION</b>	
	<p><b>Application</b>                      Beckhoff EtherCAT modules are intended for use with Beckhoff's UL Listed EtherCAT System only.</p>
<b>⚠ CAUTION</b>	
	<p><b>Examination</b>                      For cULus examination, the Beckhoff I/O System has only been investigated for risk of fire and electrical shock (in accordance with UL508 and CSA C22.2 No. 142).</p>
<b>⚠ CAUTION</b>	
	<p><b>For devices with Ethernet connectors</b>                      Not for connection to telecommunication circuits.</p>

#### Basic principles

UL certification according to UL508. Devices with this kind of certification are marked by this sign:



## 5.4 Installation on mounting rails

### ⚠ WARNING

#### Risk of electric shock and damage of device!

Bring the bus terminal system into a safe, powered down state before starting installation, disassembly or wiring of the bus terminals!

The Bus Terminal system and is designed for mounting in a control cabinet or terminal box.

#### Assembly

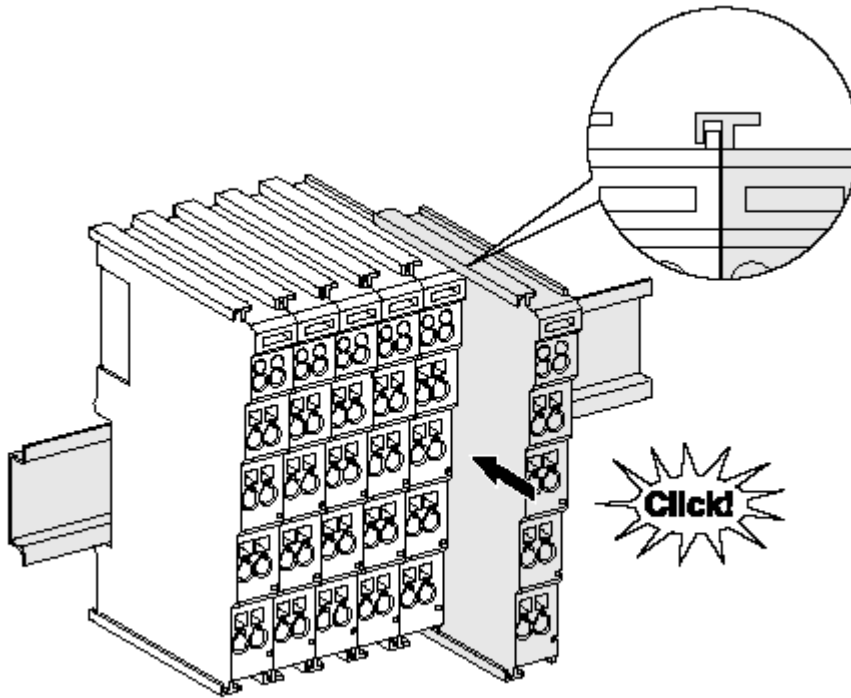

Fig. 45: Attaching on mounting rail

The bus coupler and bus terminals are attached to commercially available 35 mm mounting rails (DIN rails according to EN 60715) by applying slight pressure:

1. First attach the fieldbus coupler to the mounting rail.
2. The bus terminals are now attached on the right-hand side of the fieldbus coupler. Join the components with tongue and groove and push the terminals against the mounting rail, until the lock clicks onto the mounting rail.

If the terminals are clipped onto the mounting rail first and then pushed together without tongue and groove, the connection will not be operational! When correctly assembled, no significant gap should be visible between the housings.

#### **i** Fixing of mounting rails

The locking mechanism of the terminals and couplers extends to the profile of the mounting rail. At the installation, the locking mechanism of the components must not come into conflict with the fixing bolts of the mounting rail. To mount the mounting rails with a height of 7.5 mm under the terminals and couplers, you should use flat mounting connections (e.g. countersunk screws or blind rivets).



## Disassembly

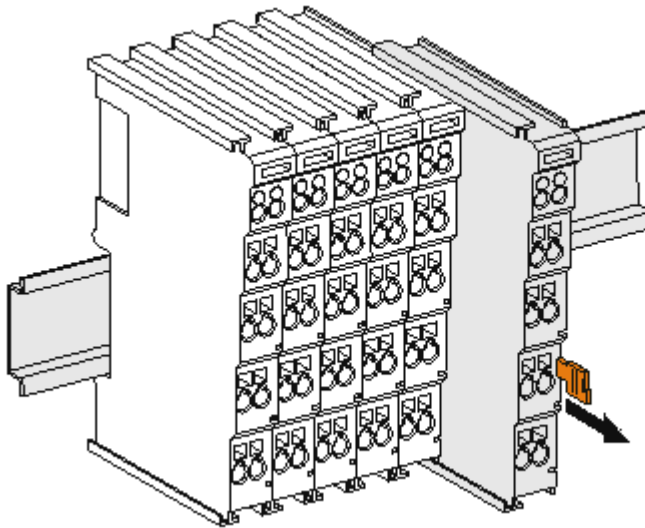

Fig. 46: Disassembling of terminal

Each terminal is secured by a lock on the mounting rail, which must be released for disassembly:

1. Pull the terminal by its orange-colored lugs approximately 1 cm away from the mounting rail. In doing so for this terminal the mounting rail lock is released automatically and you can pull the terminal out of the bus terminal block easily without excessive force.
2. Grasp the released terminal with thumb and index finger simultaneous at the upper and lower grooved housing surfaces and pull the terminal out of the bus terminal block.

## Connections within a bus terminal block

The electric connections between the Bus Coupler and the Bus Terminals are automatically realized by joining the components:

- The six spring contacts of the K-Bus/E-Bus deal with the transfer of the data and the supply of the Bus Terminal electronics.
- The power contacts deal with the supply for the field electronics and thus represent a supply rail within the bus terminal block. The power contacts are supplied via terminals on the Bus Coupler (up to 24 V) or for higher voltages via power feed terminals.

### ● Power Contacts

**i** During the design of a bus terminal block, the pin assignment of the individual Bus Terminals must be taken account of, since some types (e.g. analog Bus Terminals or digital 4-channel Bus Terminals) do not or not fully loop through the power contacts. Power Feed Terminals (KL91xx, KL92xx or EL91xx, EL92xx) interrupt the power contacts and thus represent the start of a new supply rail.

## PE power contact

The power contact labeled PE can be used as a protective earth. For safety reasons this contact mates first when plugging together, and can ground short-circuit currents of up to 125 A.

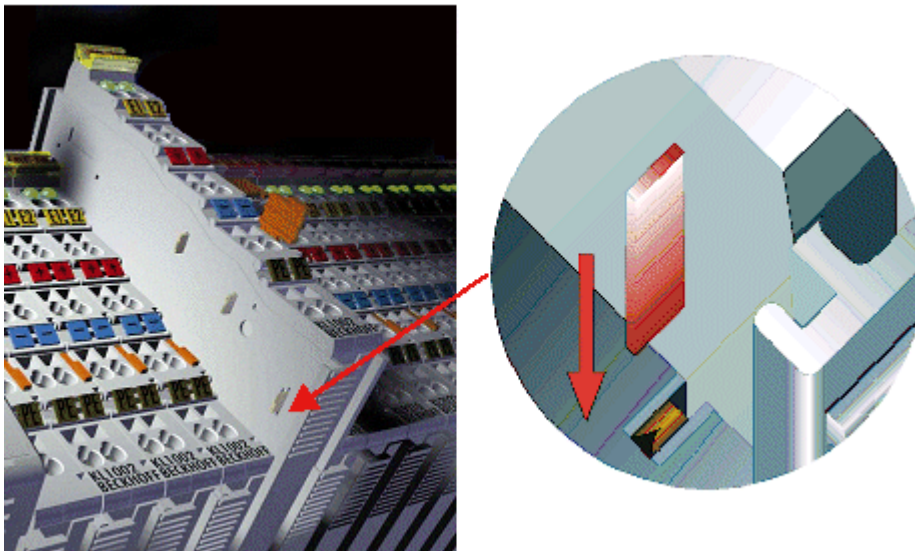

Fig. 47: Power contact on left side

**NOTICE****Possible damage of the device**

Note that, for reasons of electromagnetic compatibility, the PE contacts are capacitatively coupled to the mounting rail. This may lead to incorrect results during insulation testing or to damage on the terminal (e.g. disruptive discharge to the PE line during insulation testing of a consumer with a nominal voltage of 230 V). For insulation testing, disconnect the PE supply line at the Bus Coupler or the Power Feed Terminal! In order to decouple further feed points for testing, these Power Feed Terminals can be released and pulled at least 10 mm from the group of terminals.

**⚠ WARNING****Risk of electric shock!**

The PE power contact must not be used for other potentials!

## 5.5 Mounting and demounting - top front unlocking

The terminal modules are fastened to the assembly surface with the aid of a 35 mm mounting rail (e. g. mounting rail TH 35-15).

### ● Fixing of mounting rails

**i** The locking mechanism of the terminals and couplers extends to the profile of the mounting rail. At the installation, the locking mechanism of the components must not come into conflict with the fixing bolts of the mounting rail. To mount the recommended mounting rails under the terminals and couplers, you should use flat mounting connections (e.g. countersunk screws or blind rivets).

**⚠ WARNING****Risk of electric shock and damage of device!**

Bring the bus terminal system into a safe, powered down state before starting installation, disassembly or wiring of the Bus Terminals!

**Mounting**

- Fit the mounting rail to the planned assembly location.

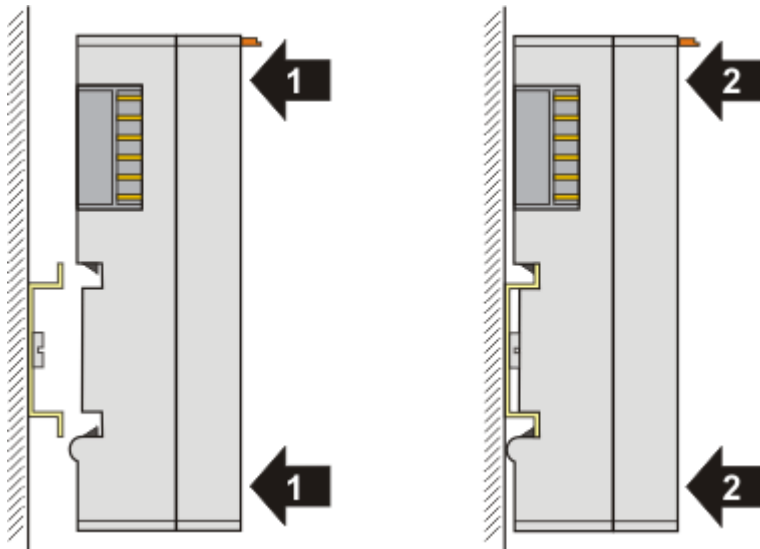

and press (1) the terminal module against the mounting rail until it latches in place on the mounting rail (2).

- Attach the cables.

**Demounting**

- Remove all the cables.
- Lever the unlatching hook back with thumb and forefinger (3). An internal mechanism pulls the two latching lugs (3a) from the top hat rail back into the terminal module.

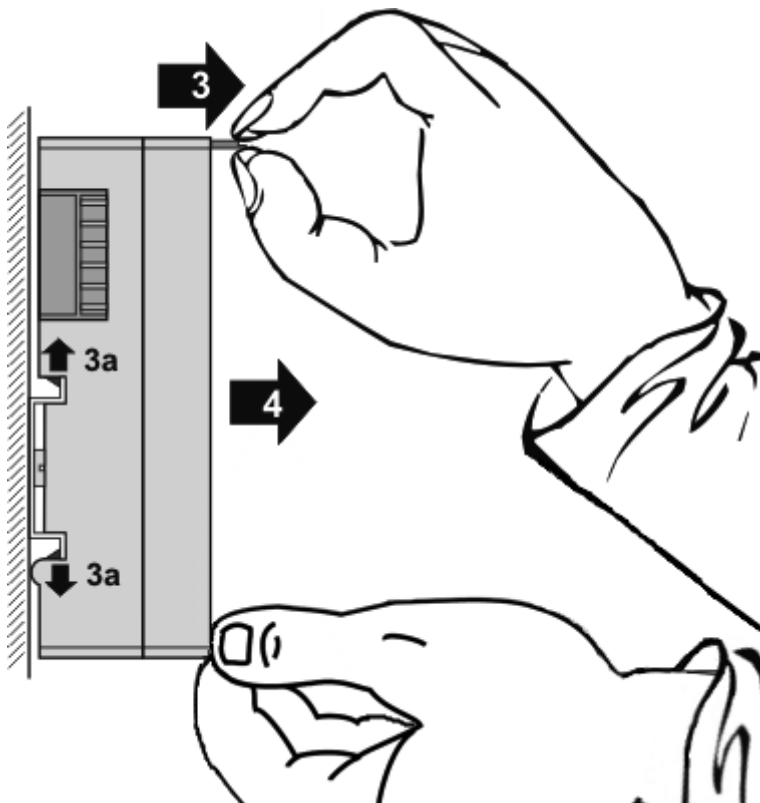

- Pull (4) the terminal module away from the mounting surface. Avoid canting of the module; you should stabilize the module with the other hand, if required.

## 5.6 Installation positions

### NOTICE

#### Constraints regarding installation position and operating temperature range

Please refer to the technical data for a terminal to ascertain whether any restrictions regarding the installation position and/or the operating temperature range have been specified. When installing high power dissipation terminals ensure that an adequate spacing is maintained between other components above and below the terminal in order to guarantee adequate ventilation!

#### Optimum installation position (standard)

The optimum installation position requires the mounting rail to be installed horizontally and the connection surfaces of the EL/KL terminals to face forward (see Fig. *Recommended distances for standard installation position*). The terminals are ventilated from below, which enables optimum cooling of the electronics through convection. "From below" is relative to the acceleration of gravity.

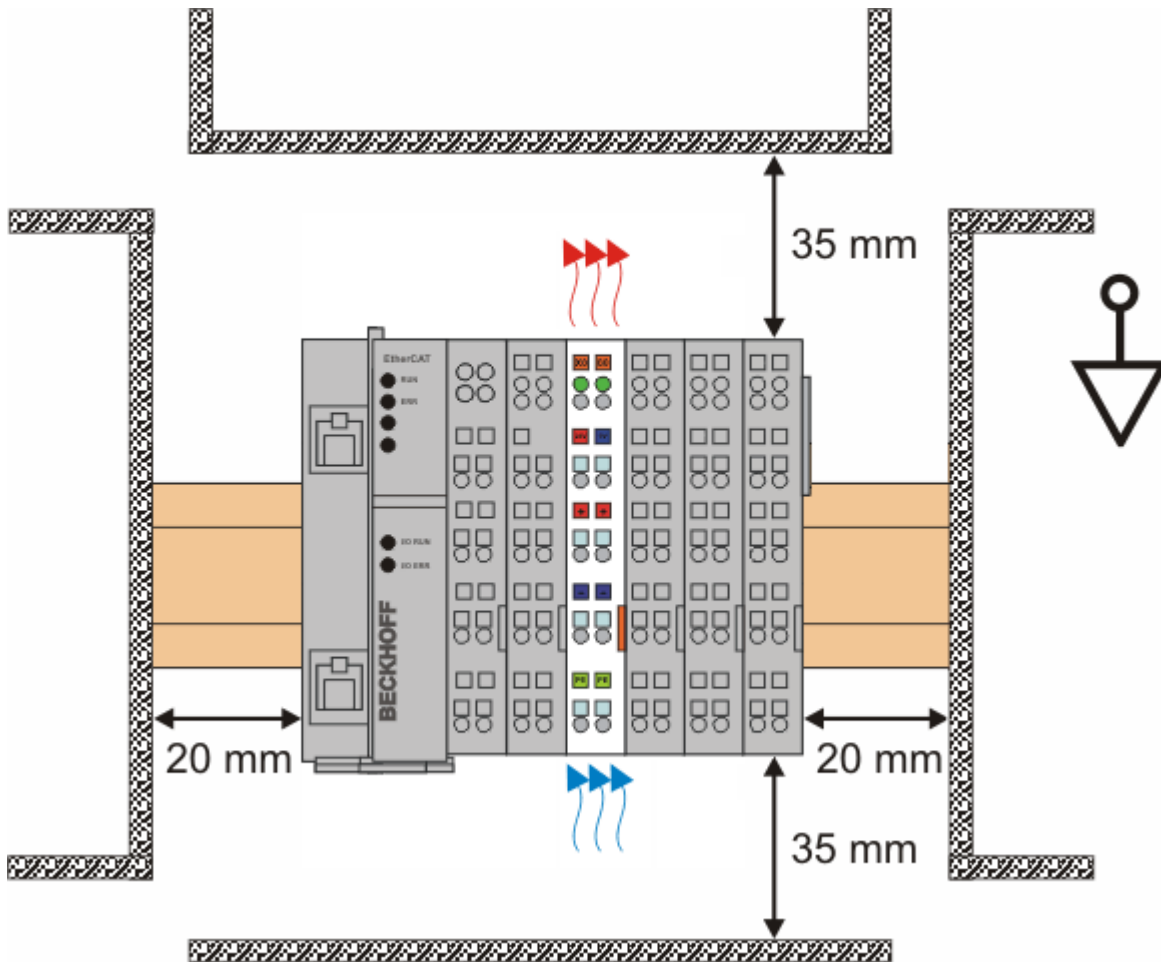

Fig. 48: Recommended distances for standard installation position

Compliance with the distances shown in Fig. *Recommended distances for standard installation position* is recommended.

#### Other installation positions

All other installation positions are characterized by different spatial arrangement of the mounting rail - see Fig *Other installation positions*.

The minimum distances to ambient specified above also apply to these installation positions.

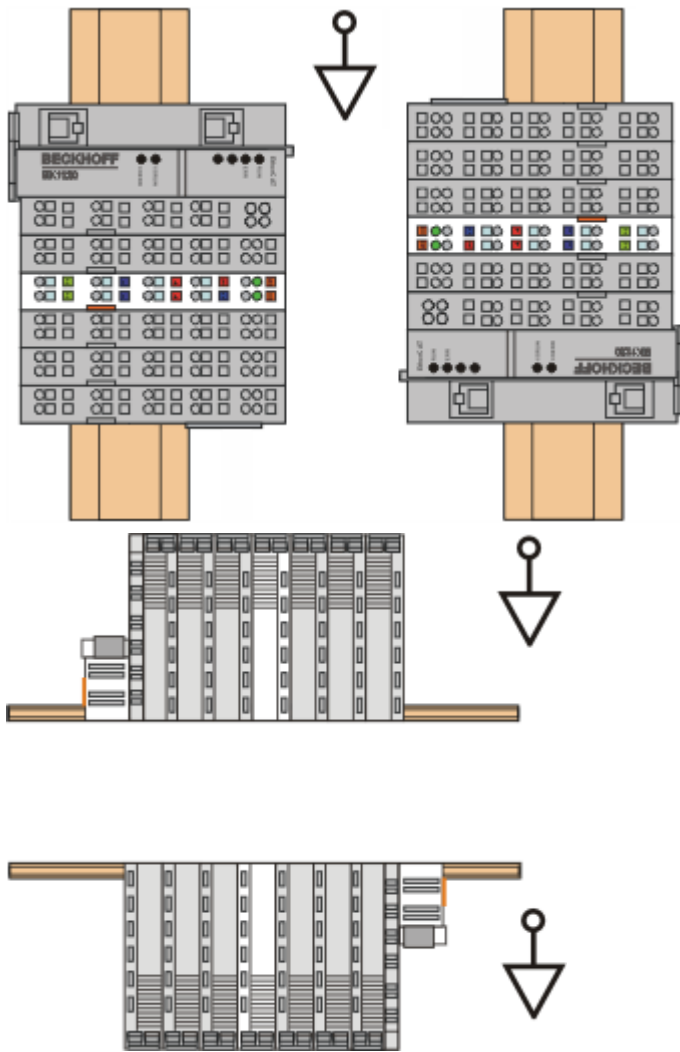

Fig. 49: Other installation positions

## 5.7 Connection system

### ⚠ WARNING

#### Risk of electric shock and damage of device!

Bring the bus terminal system into a safe, powered down state before starting installation, disassembly or wiring of the bus terminals!

#### Overview

The bus terminal system offers different connection options for optimum adaptation to the respective application:

- The terminals of ELxxxx and KLxxxx series with standard wiring include electronics and connection level in a single enclosure.
- The terminals of ESxxxx and KSxxxx series feature a pluggable connection level and enable steady wiring while replacing.
- The High Density Terminals (HD Terminals) include electronics and connection level in a single enclosure and have advanced packaging density.

#### Standard wiring (ELxxxx / KLxxxx)



Fig. 50: Standard wiring

The terminals of ELxxxx and KLxxxx series have been tried and tested for years. They feature integrated screwless spring force technology for fast and simple assembly.

#### Pluggable wiring (ESxxxx / KSxxxx)



Fig. 51: Pluggable wiring

The terminals of ESxxxx and KSxxxx series feature a pluggable connection level. The assembly and wiring procedure is the same as for the ELxxxx and KLxxxx series. The pluggable connection level enables the complete wiring to be removed as a plug connector from the top of the housing for servicing. The lower section can be removed from the terminal block by pulling the unlocking tab. Insert the new component and plug in the connector with the wiring. This reduces the installation time and eliminates the risk of wires being mixed up.

The familiar dimensions of the terminal only had to be changed slightly. The new connector adds about 3 mm. The maximum height of the terminal remains unchanged.

A tab for strain relief of the cable simplifies assembly in many applications and prevents tangling of individual connection wires when the connector is removed.

Conductor cross sections between 0.08 mm<sup>2</sup> and 2.5 mm<sup>2</sup> can continue to be used with the proven spring force technology.

The overview and nomenclature of the product names for ESxxxx and KSxxxx series has been retained as known from ELxxxx and KLxxxx series.

### High Density Terminals (HD Terminals)



Fig. 52: High Density Terminals

The terminals from these series with 16 terminal points are distinguished by a particularly compact design, as the packaging density is twice as large as that of the standard 12 mm bus terminals. Massive conductors and conductors with a wire end sleeve can be inserted directly into the spring loaded terminal point without tools.

#### ● **Wiring HD Terminals**



The High Density Terminals of the ELx8xx and KLx8xx series doesn't support pluggable wiring.

### Ultrasonically “bonded” (ultrasonically welded) conductors

#### ● **Ultrasonically “bonded” conductors**



It is also possible to connect the Standard and High Density Terminals with ultrasonically “bonded” (ultrasonically welded) conductors. In this case, please note the tables concerning the wire-size width [▶ 72]!

## 5.8 Wiring

### ⚠ **WARNING**

#### **Risk of electric shock and damage of device!**

Bring the bus terminal system into a safe, powered down state before starting installation, disassembly or wiring of the bus terminals!

**Terminals for standard wiring ELxxxx/KLxxxx and for pluggable wiring ESxxxx/KSxxxx**

Fig. 53: Connecting a cable on a terminal point

Up to eight terminal points enable the connection of solid or finely stranded cables to the bus terminal. The terminal points are implemented in spring force technology. Connect the cables as follows:

1. Open a terminal point by pushing a screwdriver straight against the stop into the square opening above the terminal point. Do not turn the screwdriver or move it alternately (don't toggle).
2. The wire can now be inserted into the round terminal opening without any force.
3. The terminal point closes automatically when the pressure is released, holding the wire securely and permanently.

See the following table for the suitable wire size width.

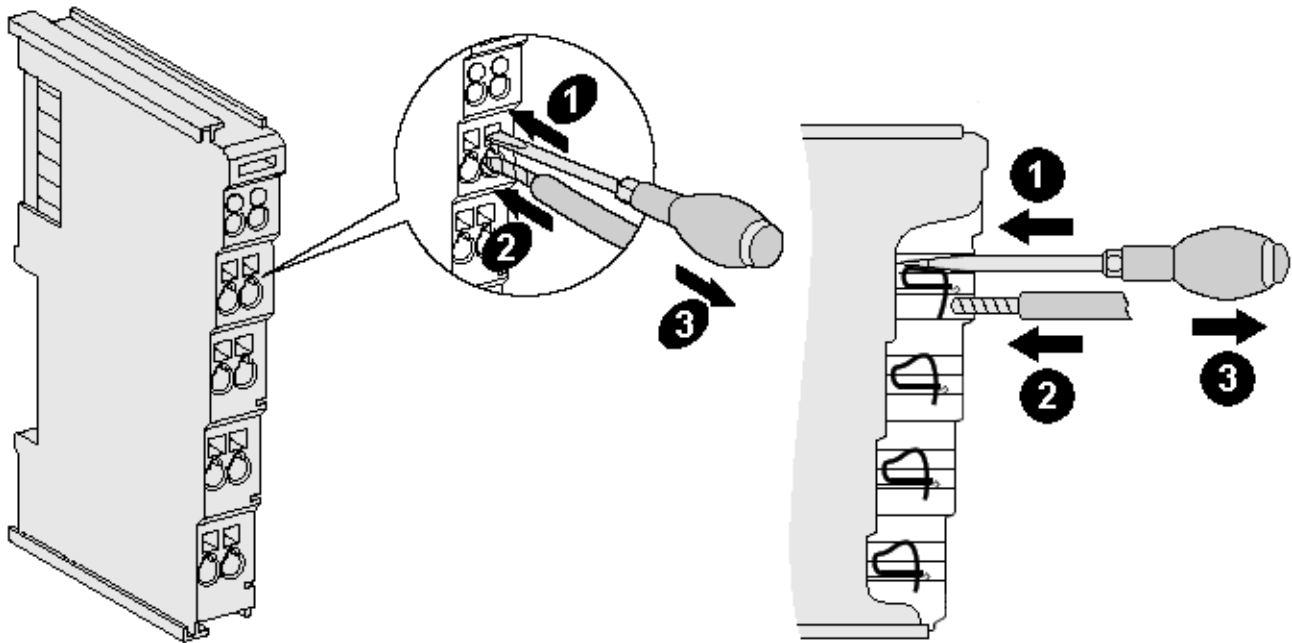
Terminal housing	ELxxxx, KLxxxx	ESxxxx, KSxxxx
Wire size width (single core wires)	0.08 ... 2.5 mm <sup>2</sup>	0.08 ... 2.5 mm <sup>2</sup>
Wire size width (fine-wire conductors)	0.08 ... 2.5 mm <sup>2</sup>	0.08 ... 2.5 mm <sup>2</sup>
Wire size width (conductors with a wire end sleeve)	0.14 ... 1.5 mm <sup>2</sup>	0.14 ... 1.5 mm <sup>2</sup>
Wire stripping length	8 ... 9 mm	9 ... 10 mm

**High Density Terminals ([HD Terminals](#) [▶ 71]) with 16 terminal points**

The conductors of the HD Terminals are connected without tools for single-wire conductors using the direct plug-in technique, i.e. after stripping the wire is simply plugged into the terminal point. The cables are released, as usual, using the contact release with the aid of a screwdriver. See the following table for the suitable wire size width.

Terminal housing	High Density Housing
Wire size width (single core wires)	0.08 ... 1.5 mm <sup>2</sup>
Wire size width (fine-wire conductors)	0.25 ... 1.5 mm <sup>2</sup>
Wire size width (conductors with a wire end sleeve)	0.14 ... 0.75 mm <sup>2</sup>
Wire size width (ultrasonically "bonded" conductors)	only 1.5 mm <sup>2</sup> (see <a href="#">notice</a> [▶ 71])
Wire stripping length	8 ... 9 mm



## 5.9 EtherCAT cabling – wire-bound

The cable length between two EtherCAT devices must not exceed 100 m. This results from the FastEthernet technology, which, above all for reasons of signal attenuation over the length of the cable, allows a maximum link length of 5 + 90 + 5 m if cables with appropriate properties are used. See also the [Design recommendations for the infrastructure for EtherCAT/Ethernet](#).

### Cables and connectors

For connecting EtherCAT devices only Ethernet connections (cables + plugs) that meet the requirements of at least category 5 (CAT5) according to EN 50173 or ISO/IEC 11801 should be used. EtherCAT uses 4 wires for signal transfer.

EtherCAT uses RJ45 plug connectors, for example. The pin assignment is compatible with the Ethernet standard (ISO/IEC 8802-3).

Pin	Color of conductor	Signal	Description
1	yellow	TD +	Transmission Data +
2	orange	TD -	Transmission Data -
3	white	RD +	Receiver Data +
6	blue	RD -	Receiver Data -

Due to automatic cable detection (auto-crossing) symmetric (1:1) or cross-over cables can be used between EtherCAT devices from Beckhoff.

### ● Recommended cables

- i** It is recommended to use the appropriate Beckhoff components e.g.
- cable sets ZK1090-9191-xxxx respectively
  - RJ45 connector, field assembly ZS1090-0005
  - EtherCAT cable, field assembly ZB9010, ZB9020

Suitable cables for the connection of EtherCAT devices can be found on the [Beckhoff website!](#)

### E-Bus supply

A bus coupler can supply the EL terminals added to it with the E-bus system voltage of 5 V; a coupler is thereby loadable up to 2 A as a rule (see details in respective device documentation). Information on how much current each EL terminal requires from the E-bus supply is available online and in the catalogue. If the added terminals require more current than the coupler can supply, then power feed terminals (e.g. [EL9410](#)) must be inserted at appropriate places in the terminal strand.

The pre-calculated theoretical maximum E-Bus current is displayed in the TwinCAT System Manager. A shortfall is marked by a negative total amount and an exclamation mark; a power feed terminal is to be placed before such a position.

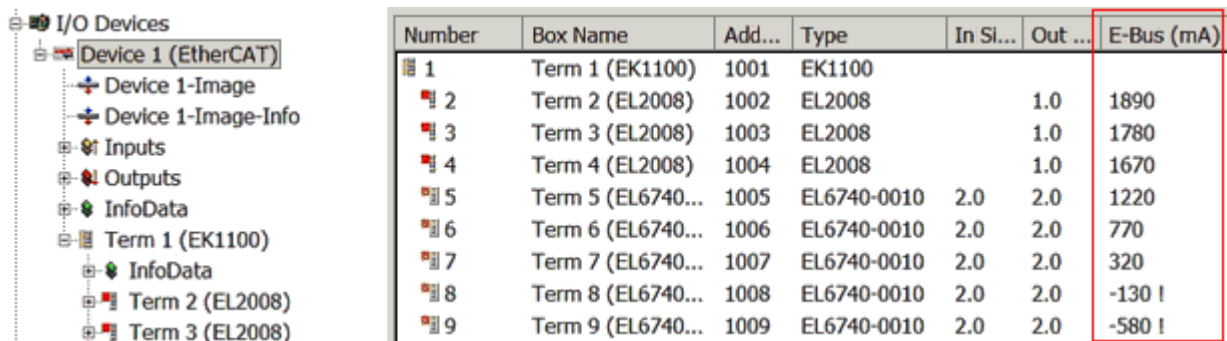

Fig. 54: System manager current calculation

### NOTICE

#### Malfunction possible!

The same ground potential must be used for the E-Bus supply of all EtherCAT terminals in a terminal block!

## 5.10 M8 Connector - Cabling

A list of the EtherCAT cable, power cable, sensor cable, Ethernet-/EtherCAT connectors and the field assembled connectors can be found at the following link: <https://www.beckhoff.com/en-us/products/i-o/accessories/>

You can find the corresponding data sheets at the following link: <https://www.beckhoff.com/en-us/support/download-finder/data-sheets/>

### EtherCAT cable



Fig. 55: ZK1090-3131-0xxx

For connecting EtherCAT devices only shielded Ethernet cables that meet the requirements of at least **category 5 (CAT5) according to EN 50173 or ISO/IEC 11801** should be used.

#### **i** Recommendations about cabling

You may get detailed recommendations about cabling EtherCAT from the documentation "Recommendations for the design of the infrastructure for EtherCAT/Ethernet", that is available for download at [www.Beckhoff.com](http://www.Beckhoff.com).

EtherCAT uses 4 wires for signal transfer.

Due to automatic cable detection (auto-crossing) symmetric (1:1) or cross-over cables can be used between EtherCAT devices from Beckhoff.

### M8 Connector - pin assignment



Signal	Description	Pin (M8)
Tx+	Transmit Data+	1
Tx-	Transmit Data-	4
Rx+	Receive Data+	2
Rx-	Receive Data-	3
Shield	Shielding	Housing

### 5.11 Nut torque for connectors



Fig. 56: X1 and X2 of EK1122-0008

For usage of the EtherCAT connectors M8 of EK1122-0008 the following have to be noticed:

#### M8 connectors

It is recommended to pull the M8 connectors tight with a nut torque of **0.4 Nm**. When using the torque control screwdriver [ZB8800](#) is also a max. torque of **0.5 Nm** permissible.

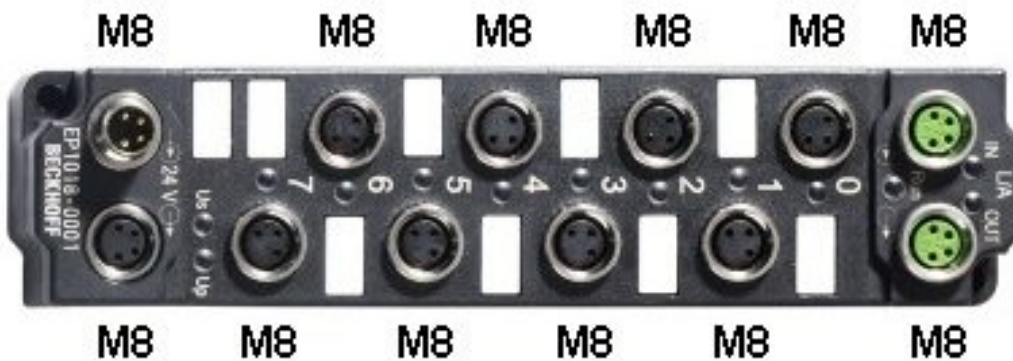

Fig. 57: EtherCAT Box with M8 connectors

## 5.12 Note - Power supply

### ⚠ WARNING

#### Power supply from SELV/PELV power supply unit!

SELV/PELV circuits (Safety Extra Low Voltage, Protective Extra Low Voltage) according to IEC 61010-2-201 must be used to supply this device.

Notes:

- SELV/PELV circuits may give rise to further requirements from standards such as IEC 60204-1 et al, for example with regard to cable spacing and insulation.
- A SELV (Safety Extra Low Voltage) supply provides safe electrical isolation and limitation of the voltage without a connection to the protective conductor, a PELV (Protective Extra Low Voltage) supply also requires a safe connection to the protective conductor.

## 5.13 Power supply, potential groups

### Bus Coupler power supply

The Bus Couplers require a 24 V<sub>DC</sub> supply for their operation. The connection is made by means of the upper spring-loaded terminals labelled 24 V and 0 V. The supply voltage is used by the Bus Coupler electronics and for direct voltage generation for the E-bus. The voltage generation for the E-bus takes place in a DC/DC converter without electrical isolation.

The EK1xxx units supply the E-bus with max. 2,000 mA E-bus current. Power feed terminals are to be inserted if the added terminals require more current.

### Input for power contacts

The bottom six connections with spring-loaded terminals can be used to feed the supply for the peripherals. The spring-loaded terminals are joined in pairs to a power contact. The feed for the power contacts has no connection to the voltage supply for the Bus Coupler. The design of the feed permits voltages of up to 24 V. The assignment in pairs and the electrical connection between feed terminal contacts allows the connection wires to be looped through to various terminal points. The current load via the power contacts may not permanently exceed 10 A; the supply line must therefore be protected by a 10 A fuse (slow-blow).

### Power contacts

On the right hand face of the Bus Coupler there are three spring contacts for the power contact connections. The spring contacts are hidden in slots so that they can not be accidentally touched. By attaching a Bus Terminal the blade contacts on the left hand side of the Bus Terminal are connected to the spring contacts. The tongue and groove guides on the top and bottom of the Bus Coupler and of the Bus Terminals guarantees that the power contacts mate securely.

The current load of the power contacts may not permanently exceed 10 A.

### Electrical isolation

The bus couplers operate by means of three independent potential groups. The supply voltage feeds the E-bus electronics in the bus coupler and the E-bus itself, which are electrically isolated. The supply voltage is also used to generate the operating voltage for the fieldbus.

Note: All the Bus Terminals are electrically isolated from the E-bus. The E-bus is thus electrically isolated from everything else.

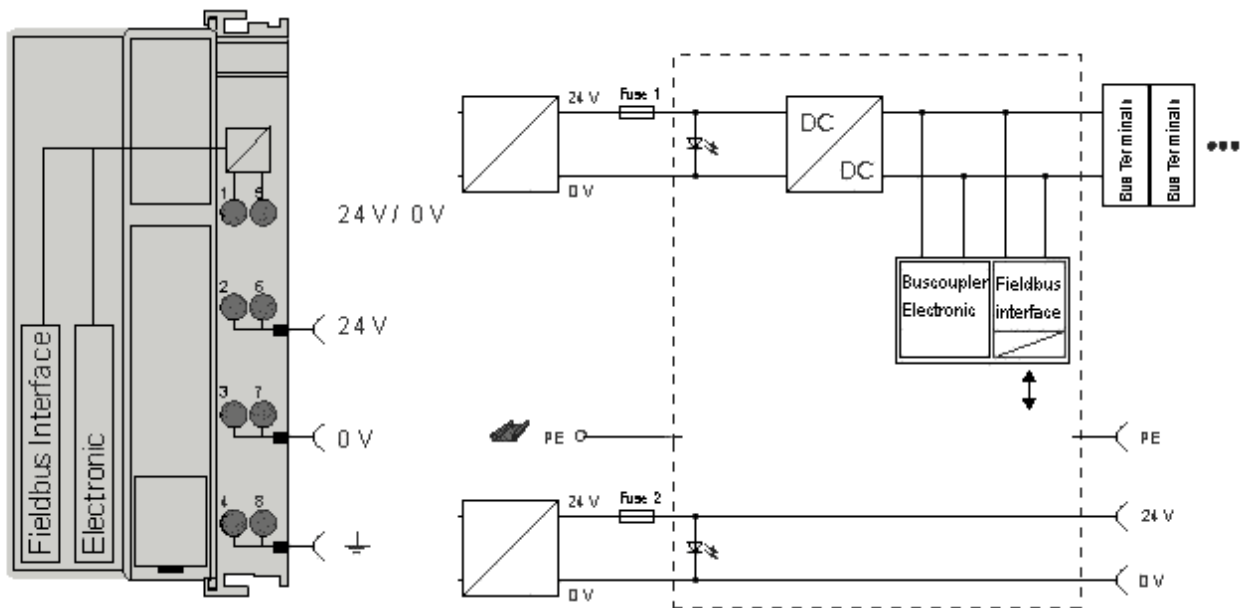

Fig. 58: Potential diagram EKxxxx

**GND concept**

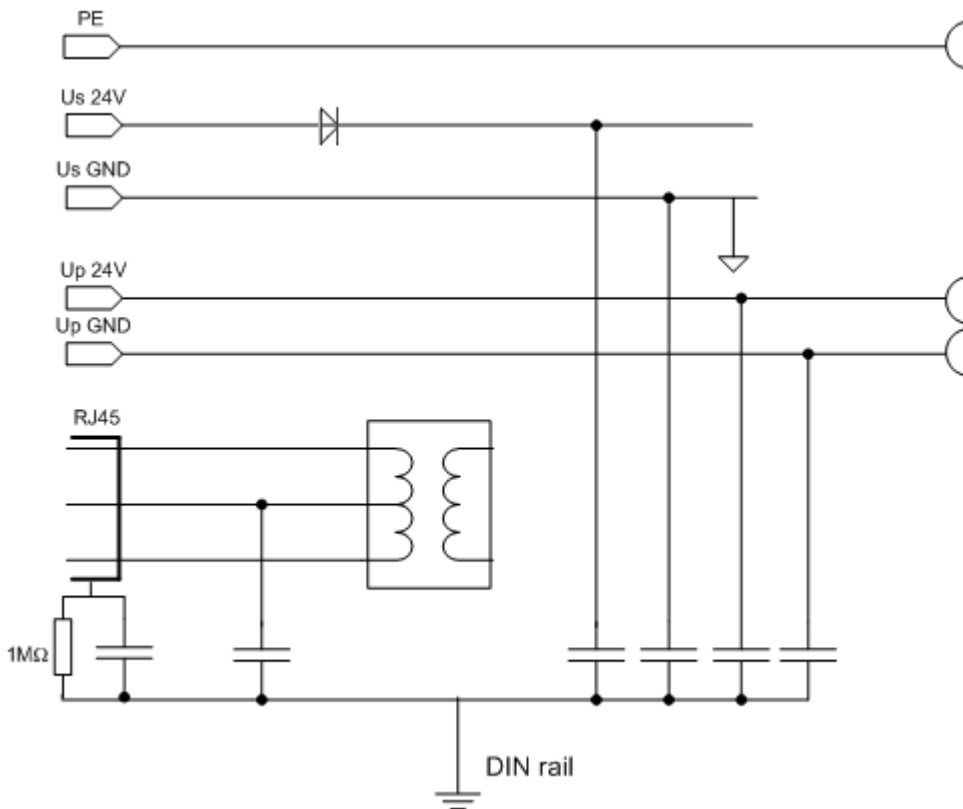

Fig. 59: GND concept EKxxxx

**Fuse protection**

**Coupler supply, fuse 1:**

depending on the required current consumption and hence the configured terminals  
typical max. 1 A

**Power contacts, fuse 2:**

permitted max. 10 A (slow-blow)

The coupler electronics and the power contacts can be supplied together from the same source. In this case the fuse should be dimensioned for 10 A max.

## 5.14 Positioning of passive Terminals

**i** **Hint for positioning of passive terminals in the bus terminal block**

EtherCAT Terminals (ELxxxx / ESxxxx), which do not take an active part in data transfer within the bus terminal block are so called passive terminals. The passive terminals have no current consumption out of the E-Bus.

To ensure an optimal data transfer, you must not directly string together more than two passive terminals!

**Examples for positioning of passive terminals (highlighted)**

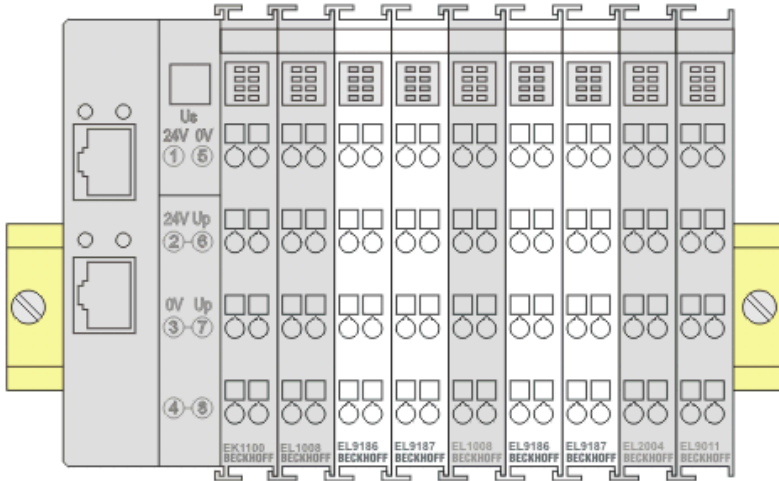

Fig. 60: Correct positioning

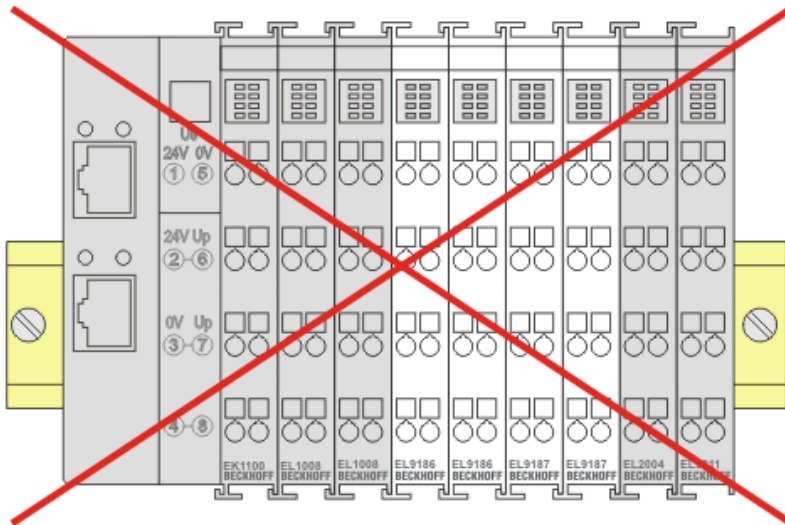

Fig. 61: Incorrect positioning

## 5.15 Disposal



Products marked with a crossed-out wheeled bin shall not be discarded with the normal waste stream. The device is considered as waste electrical and electronic equipment. The national regulations for the disposal of waste electrical and electronic equipment must be observed.



## 6 Basics

### 6.1 EtherCAT basics

Please refer to the [EtherCAT System Documentation](#) for the EtherCAT fieldbus basics.

### 6.2 Basic function principles of EtherCAT junctions

Some Beckhoff EtherCAT devices can be used for junctions in the EtherCAT segment. These include EK1122, EK1521, EP1122 or also CU112x. In the following examples only the EK1122 is used. The technical and system characteristics of the other devices are similar.

#### EtherCAT handling in the slaves

With EtherCAT as fieldbus protocol a wide range of bus topologies can be used: line, star and tree topology, with redundancy support even ring topology. The simplest topology is the line topology, in which each EtherCAT slave passes the data on to the *only* next slave; see following Fig. *EtherCAT line topology*.

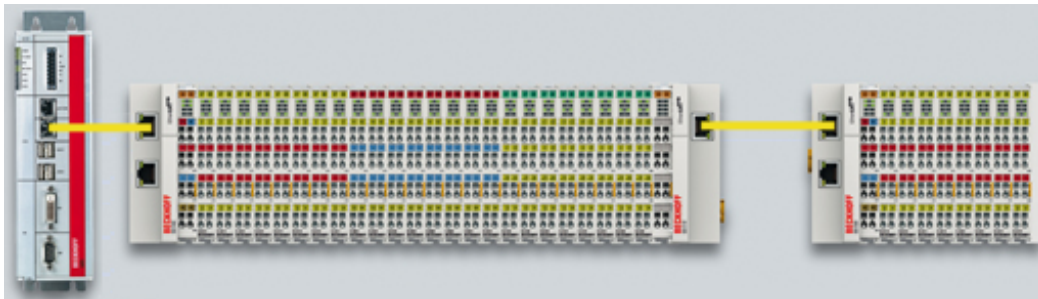

Fig. 62: EtherCAT line topology

When using, for example, EK1100 EtherCAT Couplers, a junction and thus a type of tree topology is possible; see following Fig. *Line topology with extensions*.

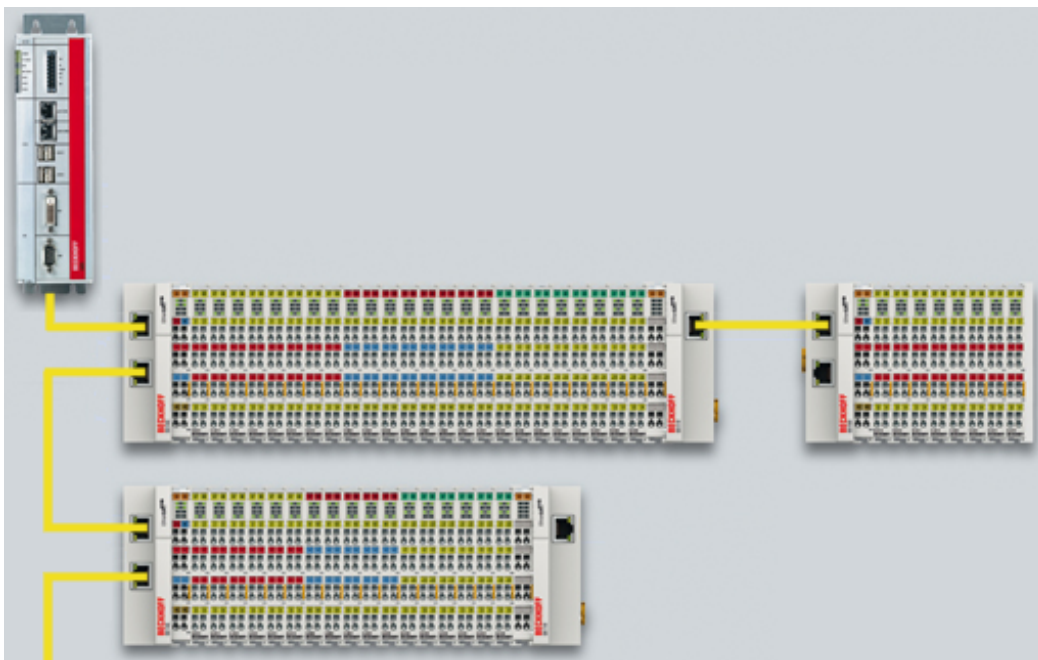

Fig. 63: Line topology with extensions

The basic principle is that internally the Ethernet frame(s) with the EtherCAT protocol data continue to be transported in a logical ring:

- the EtherCAT master sends the frame on the two outgoing lines of the Ethernet cable

- this frame passes each slave once,
- is reversed by the last slave in the logical sequence
- and is returned to the master through each EtherCAT slave via two return lines of the Ethernet cable without further processing.

At short cycle times in the order of 50  $\mu$ s at 20,000 Ethernet frames are in transit in the EtherCAT system every second, plus acyclic organizational frames. The master awaits the return of the sent frames, which return the device input data to the master, for example. Telegram transfer between slaves is link-based: An EtherCAT slave will only forward a frame if a 'link' signal to the next device is present. Normally it can be assumed that the downstream device correctly processes each EtherCAT telegram and returns or process it at the end.

The crucial factor for forwarding EtherCAT telegrams is that a link signal is reported only from one slave to the next if both slaves are actually ready for real-time participation in data processing. Specifically, this means that an EtherCAT slave should not open the respective Ethernet port until it is ready to receive and forward an Ethernet frame immediately.

A switch or router is usually used for standard Ethernet traffic forwarding. Any collisions or frame losses are compensated through frame repetition in the higher level protocol layers (e.g. TCP). This mode is generally not used for EtherCAT due to the short cycle times and the real-time requirement. Some Ethernet devices such as special switches, for example, report a link to the remote terminal even if they will only be ready for data processing in a few milliseconds. This behavior is particularly noticeable in media converters from 100Base-TX (copper) to 100Base-Fx (optical fiber), which may report a link to the preceding EtherCAT slave even if the optical fiber connection is interrupted, depending on the setting on the copper side.

Fast link detection is therefore a central component of each ESC (EtherCAT slave controller, hardware processing unit for the EtherCAT protocol). According to the EtherCAT specification an ESC can have and control one to four ports. Via an open port it can handle outgoing and incoming Ethernet traffic. The direction of data flow in a fully configured ESC is shown in Fig. *Direction of data flow in the ESC* – the data in the EtherCAT datagrams are thereby processed only between Ports 0 (A) and 3 (D) in the EtherCAT processing unit.

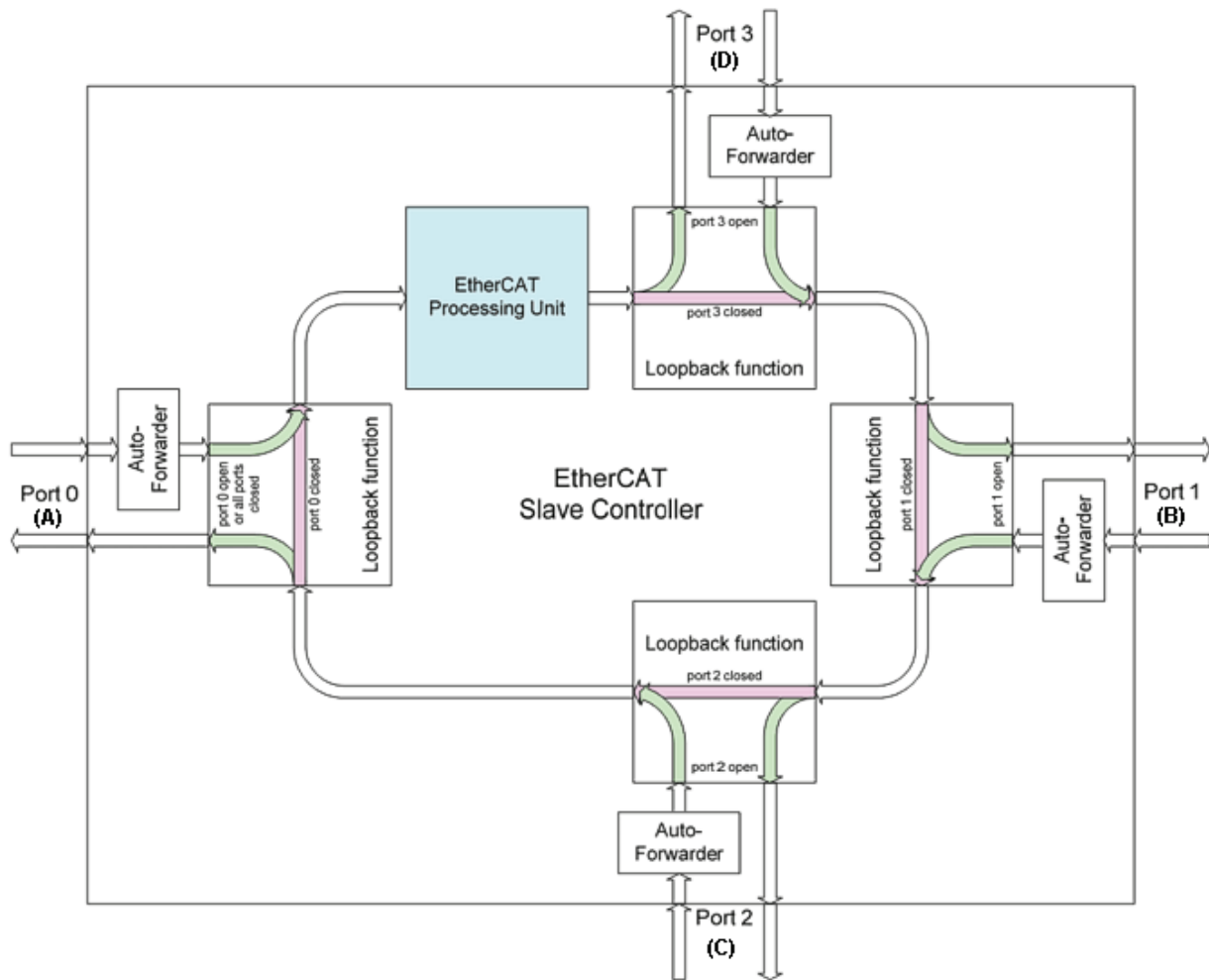

Fig. 64: Direction of data flow in the ESC

Ideally link detection and therefore port handling in the ESC should be fast enough that lost frame events are avoided even at 100  $\mu$ s cycle time. Nevertheless, at least one lost frame can never be ruled out if a connection is disconnected while an Ethernet frame is in transit on this line and in the bus segment downstream of the separation point.

**Implementation: EL terminal**

A standard EtherCAT slave such as a Beckhoff EL terminal has two ports:

- one for incoming frames (port 0 [A])
- and one for outgoing frames (e.g. port [D]).

The other two ports are internally closed in the ESC. An EtherCAT telegram enters the processing unit via port 0 (A)/top and is forwarded to the next slave via port 3 (D)/left, if a link to this port exists - see green arrows. This is the case if a further EL terminal is connected to the right.

If no link exists, the frame is forwarded to port 1(B) via the purple route. This and port 2 (C) have no link and therefore return the frame to port 0 (A), where the frame leaves via the same Ethernet port through which it arrived at the slave. This is the case if the terminal acts as end terminal.

An EtherCAT device with a single port is therefore only of limited use, since it can only be used as end device.

**Implementation: EK1100 EtherCAT Coupler**

Three of the four available ports in the EK1100 EtherCAT Coupler are used, thus enabling a connection to the right to terminals and via an RJ45 socket to further couplers; cf. Fig. "Line topology with extensions [► 81]". In the EK1100 the processing unit is not used for process data exchange.

**Implementation: EK1121-0010 EtherCAT junction, Extended Distance**

As in the EK1100, three ESC ports can be connected in these junctions: Two via E-bus within the terminal and one via the RJ45 sockets with Ethernet configuration.

**Implementation: EK1122 EtherCAT junction**

In the EK1122 all four ESC ports can be connected - two via the internal E-bus and two via the RJ45 sockets with Ethernet configuration. In the TwinCAT System Manager the link statuses of ports 0, 1, 2 and 3 are shown by the online display – they are designated there as ports A, B, C and D; see Fig. “Topology display for interrupted line [▶ 86]”.

**Implementation: EK1521 / EK1521-0010 / EK1561 EtherCAT junction**

As in the EK1100, three ESC ports can be connected in these junctions: Two via E-bus within the terminal and one via the SC socket/versatile link and optical fiber cable/POF line.

**Implementation: CU1123-00x0 EtherCAT junction**

In the CU1123-00x0 EtherCAT junction three of the four available ports can be connected via the RJ45 sockets.

**Implementation: CU1124 EtherCAT junction**

In the CU1124 EtherCAT junction all four available ports can be connected via the RJ45 sockets.

**Implementation: CU1128 EtherCAT junction**

The CU1128 integrates three ESCs, which means eight ports in total are available to users. The three ESCs are interconnected via E-bus.

**Example configuration with EK1122**

The following section describes the link characteristics under TwinCAT and its representation in the System Manager.

No	Addr	Name	State	CRC
1	1001	Term 1 (EK1100)	OP	0, 0
2	1002	Term 2 (EK1122)	OP	
3	1003	Term 3 (EK1100)	OP	0, 0
4	1004	Term 4 (EL3102)	OP	0
5	1005	Term 5 (EK1100)	OP	0, 0
6	1006	Term 6 (EL4732)	OP	0
7	1007	Term 7 (EL1012)	OP	0, 0
8	1008	Term 8 (EL2004)	OP	0

Counter	Cyclic	Queued
Send Frames	7131 +	6479
Frames / sec	247 +	2
Lost Frames	0 +	0
Tx/Rx Errors	0 /	0

Fig. 65: Example configuration

The TwinCAT online topology shows the wiring scheme, see Fig. *Online Topology*. The EK1122 is selected, so that further information is shown. The green bars above the slaves indicate the correct RUN state in all slaves.

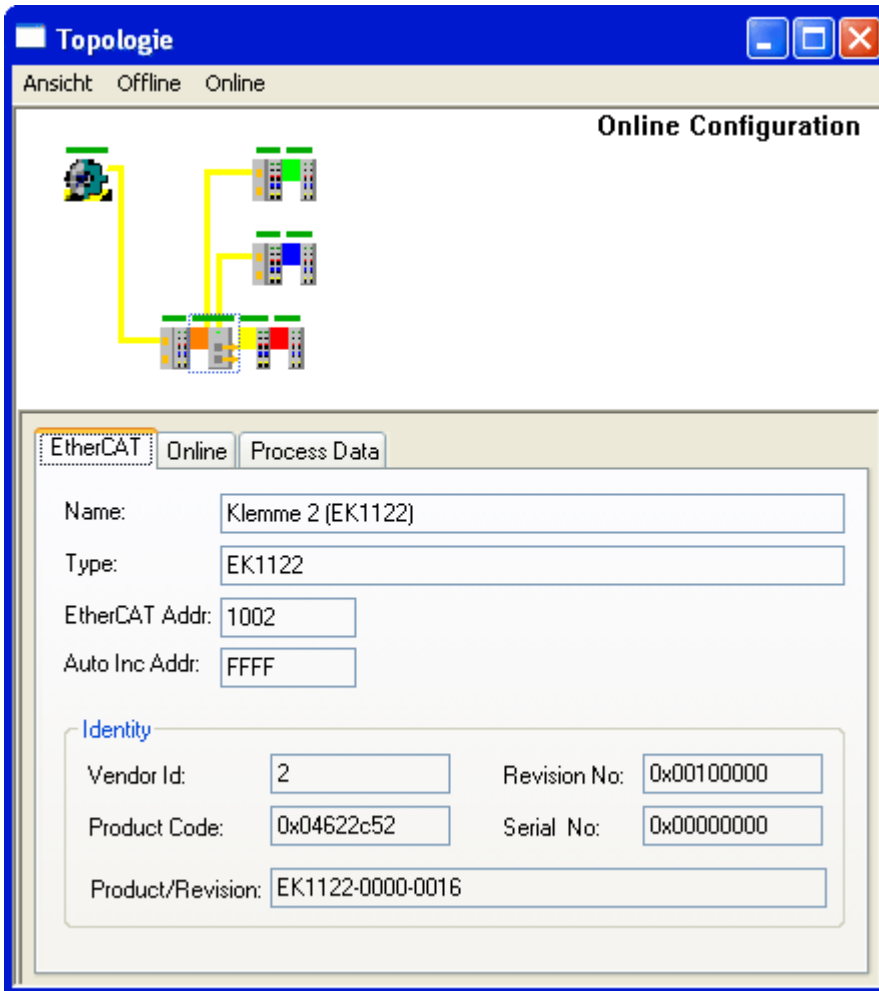

Fig. 66: Online topology

An error is now generated by disconnecting the connection between the upper RJ45 socket (X1) and the EL3102 device. Within a few  $\mu\text{s}$  the ESC in the EK1122 detects the lost link and automatically closes the affected port. This has the effect that the next incoming EtherCAT telegram is immediately forwarded to port D (port 3) and the EL4732. The link is thus missing here and the System Manager marks this in the online display; see following Fig. *Example configuration with interrupted cable*.

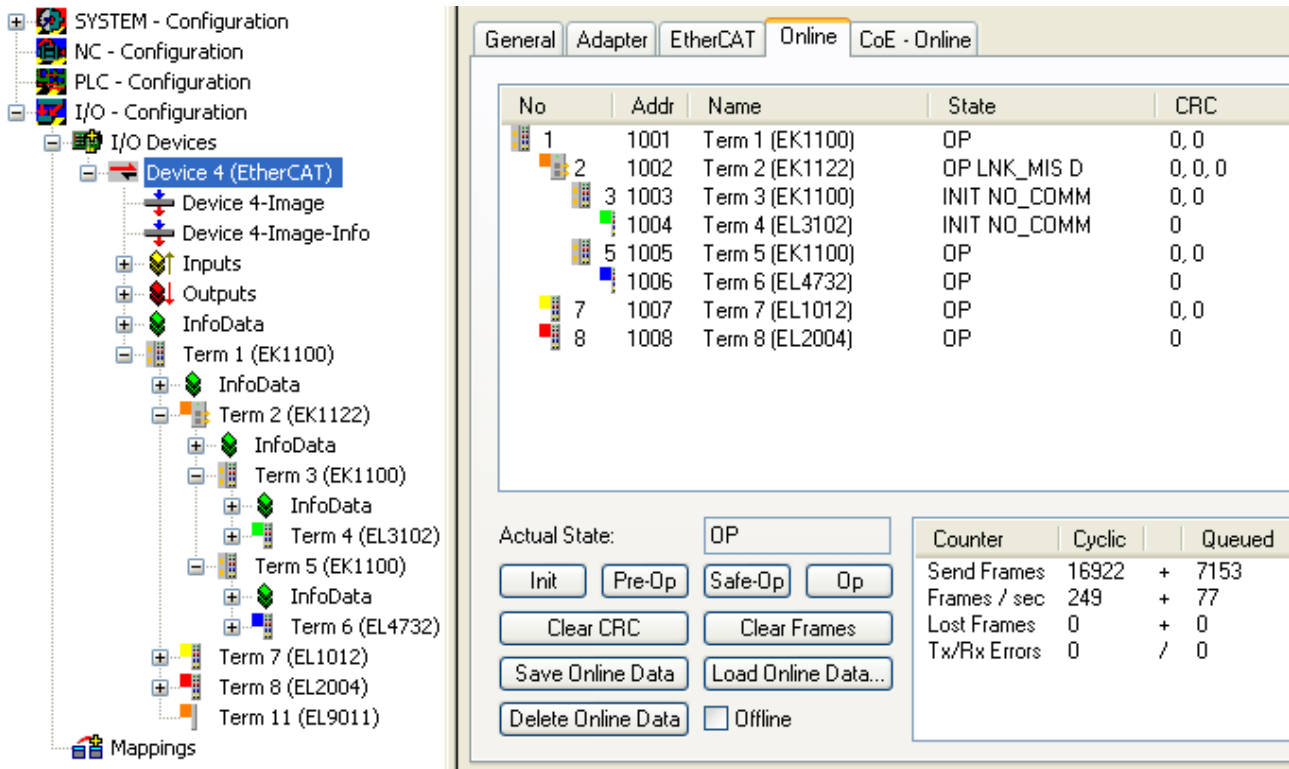

Fig. 67: Example configuration with interrupted cable

The System Manager messages can be interpreted as follows:

- Address 1002 - EK1122: “OP LNK:MIS D”: The slave is in OP state, although a link is missing at port D (3) that should be present according to the configuration
- Address 1003 - EK1100: “INIT NO\_COMM”: Since communication with this slave is interrupted its state is shown as INIT
- Address 1004 - EL3104: ditto

**● Logger output**

**I** The logger output can be displayed in the lower part of the System Manager (Display → Show Logger Output). This may be helpful for diagnostic purposes (for link interruptions and other situations).

In the topology display any slaves affected by interruption are shown with a red border, see the following Fig. *Topology display for interrupted line.*

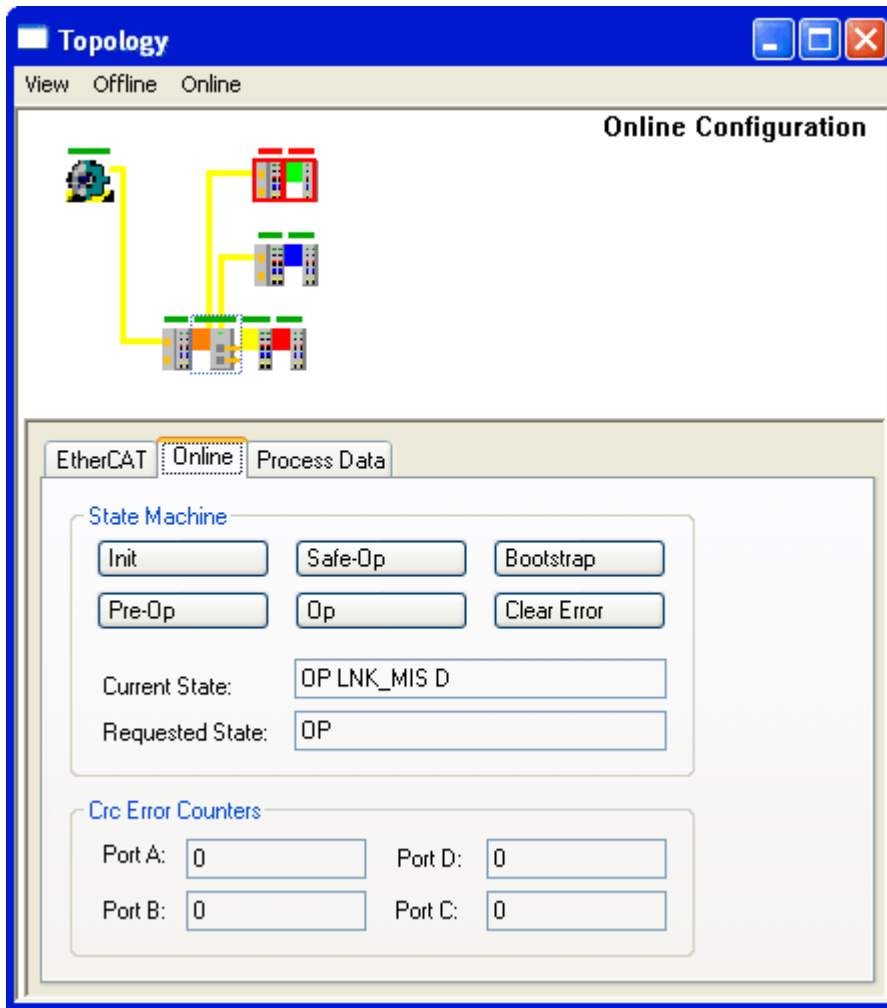

Fig. 68: Topology display for interrupted line

In Fig. "Example configuration [▶ 84]" and Fig. "Example configuration with interrupted cable" [▶ 86] note the display of acyclic frames, see the following Fig. *Comparison of the frame displays in the System Manager.*

No	Addr	Name	State	CRC
1	1001	Term 1 (EK1100)	OP	0, 0
2	1002	Term 2 (EK1122)	OP	0, 0
3	1003	Term 3 (EK1100)	OP	0, 0
4	1004	Term 4 (EL3102)	OP	0
5	1005	Term 5 (EK1100)	OP	0, 0
6	1006	Term 6 (EL4732)	OP	0
7	1007	Term 7 (EL1012)	OP	0, 0
8	1008	Term 8 (EL2004)	OP	0

No	Addr	Name	State	CRC
1	1001	Term 1 (EK1100)	OP	0, 0
2	1002	Term 2 (EK1122)	OP LNK_MIS D	0, 0, 0
3	1003	Term 3 (EK1100)	INIT NO_COMM	0, 0
4	1004	Term 4 (EL3102)	INIT NO_COMM	0
5	1005	Term 5 (EK1100)	OP	0, 0
6	1006	Term 6 (EL4732)	OP	0
7	1007	Term 7 (EL1012)	OP	0, 0
8	1008	Term 8 (EL2004)	OP	0

Counter	Cyclic	Queued
Send Frames	7131	6479
Frames / sec	247	+ 2
Lost Frames	0	+ 0
Tx/Rx Errors	0	/ 0

Counter	Cyclic	Queued
Send Frames	16922	7153
Frames / sec	249	+ 77
Lost Frames	0	+ 0
Tx/Rx Errors	0	/ 0

Fig. 69: Comparison of the frame displays in the System Manager

The image on the left shows a small number (2) of acyclic frames sent by the master during the respective second - all slaves are operating properly. The image on the right shows a significant increase (currently 77 acyclic frames/sec): The EtherCAT master has quickly detected that not all slaves are properly taking part in the data exchange. Once the master has located the fault, it continuously tries to restore the connection.

**Reconnection**

Once the connection has been restored, the EK1122 reports to the master that a link is present again at port D (3). The EtherCAT master will then make its process data available again for this section. Once the preparations are complete, it will instruct the EK1122 to re-open port D (3) for regular data exchange. Cyclic and acyclic data traffic with the other EtherCAT slaves continues normally.

**External access to EtherCAT diagnostics**

**I** The system offers a wide range of options for accessing status and diagnostic information and EtherCAT master functions from the PLC. Almost all information displayed by the System Manager online can also be retrieved via ADS (see figures on this page). System Manager functions can also be triggered via PLC or ADS. Please refer to the relevant sections in the Beckhoff Information System and the notes on EtherCAT diagnostics.

**6.3 EtherCAT State Machine**

The state of the EtherCAT slave is controlled via the EtherCAT State Machine (ESM). Depending upon the state, different functions are accessible or executable in the EtherCAT slave. Specific commands must be sent by the EtherCAT master to the device in each state, particularly during the bootup of the slave.

A distinction is made between the following states:

- Init
- Pre-Operational
- Safe-Operational and
- Operational
- Boot

The regular state of each EtherCAT slave after bootup is the OP state.

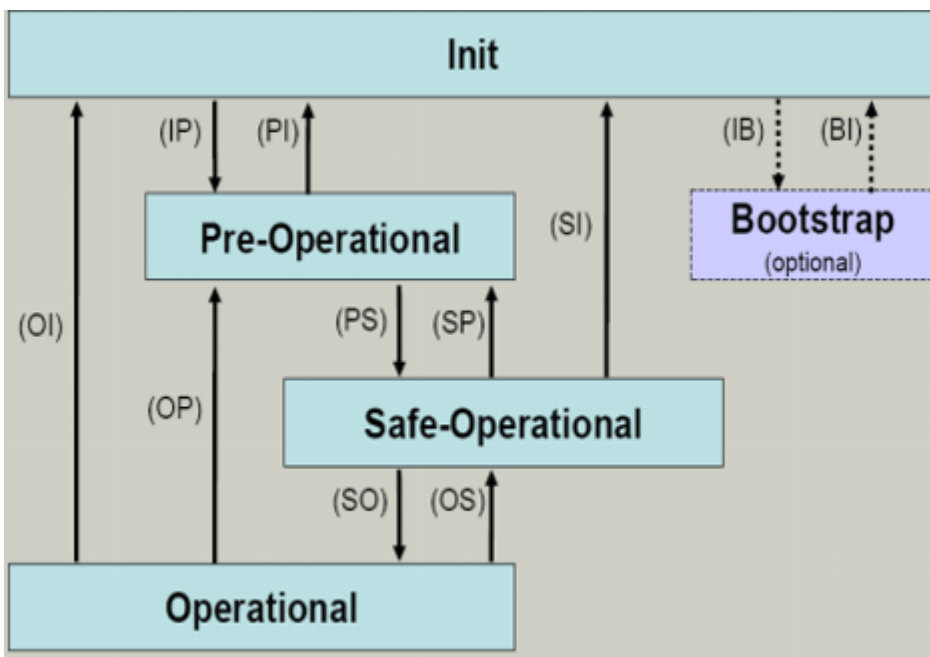

Fig. 70: States of the EtherCAT State Machine

**Init**

After switch-on the EtherCAT slave in the *Init* state. No mailbox or process data communication is possible. The EtherCAT master initializes sync manager channels 0 and 1 for mailbox communication.



### Pre-Operational (Pre-Op)

During the transition between *Init* and *Pre-Op* the EtherCAT slave checks whether the mailbox was initialized correctly.

In *Pre-Op* state mailbox communication is possible, but not process data communication. The EtherCAT master initializes the sync manager channels for process data (from sync manager channel 2), the FMMU channels and, if the slave supports configurable mapping, PDO mapping or the sync manager PDO assignment. In this state the settings for the process data transfer and perhaps terminal-specific parameters that may differ from the default settings are also transferred.

### Safe-Operational (Safe-Op)

During transition between *Pre-Op* and *Safe-Op* the EtherCAT slave checks whether the sync manager channels for process data communication and, if required, the distributed clocks settings are correct. Before it acknowledges the change of state, the EtherCAT slave copies current input data into the associated DP-RAM areas of the EtherCAT slave controller (ECSC).

In *Safe-Op* state mailbox and process data communication is possible, although the slave keeps its outputs in a safe state, while the input data are updated cyclically.

---

#### ● Outputs in SAFEOP state

**I** The default set watchdog monitoring sets the outputs of the module in a safe state - depending on the settings in SAFEOP and OP - e.g. in OFF state. If this is prevented by deactivation of the watchdog monitoring in the module, the outputs can be switched or set also in the SAFEOP state.

---

### Operational (Op)

Before the EtherCAT master switches the EtherCAT slave from *Safe-Op* to *Op* it must transfer valid output data.

In the *Op* state the slave copies the output data of the masters to its outputs. Process data and mailbox communication is possible.

### Boot

In the *Boot* state the slave firmware can be updated. The *Boot* state can only be reached via the *Init* state.

In the *Boot* state mailbox communication via the *file access over EtherCAT* (FoE) protocol is possible, but no other mailbox communication and no process data communication.

## 6.4 CoE - Interface: notes

This device has no CoE.

Detailed information on the CoE interface can be found in the [EtherCAT system documentation](#) on the Beckhoff website.

## 6.5 EKxxxx - Optional Distributed Clocks support

### Basic principles Distributed Clocks (DC)

The EtherCAT Distributed Clocks system comprises local clocks that are integrated in the EtherCAT slaves and are synchronized by the EtherCAT master via special datagrams. Not all EtherCAT slaves support the Distributed Clocks procedure. It is only supported by slaves whose function requires it. In the TwinCAT System Manager a slave indicates its DC capability by showing "DC" in the settings dialog.

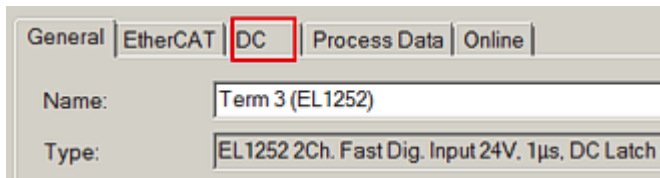

Fig. 71: DC tab for indicating the Distributed Clocks function

Once of these local clocks is the reference clock, based on which all other clocks are synchronized. See also explanatory notes in the [Basic EtherCAT documentation](#). The reference clock must be the first DC-capable EtherCAT slave. By default TwinCAT therefore selects the first DC-capable device as reference clock. This is shown (and can be modified by the user) under advanced properties of the EtherCAT master. The standard setting should not be changed, except in cases where external synchronization is recommended in the relevant documentation, for example.

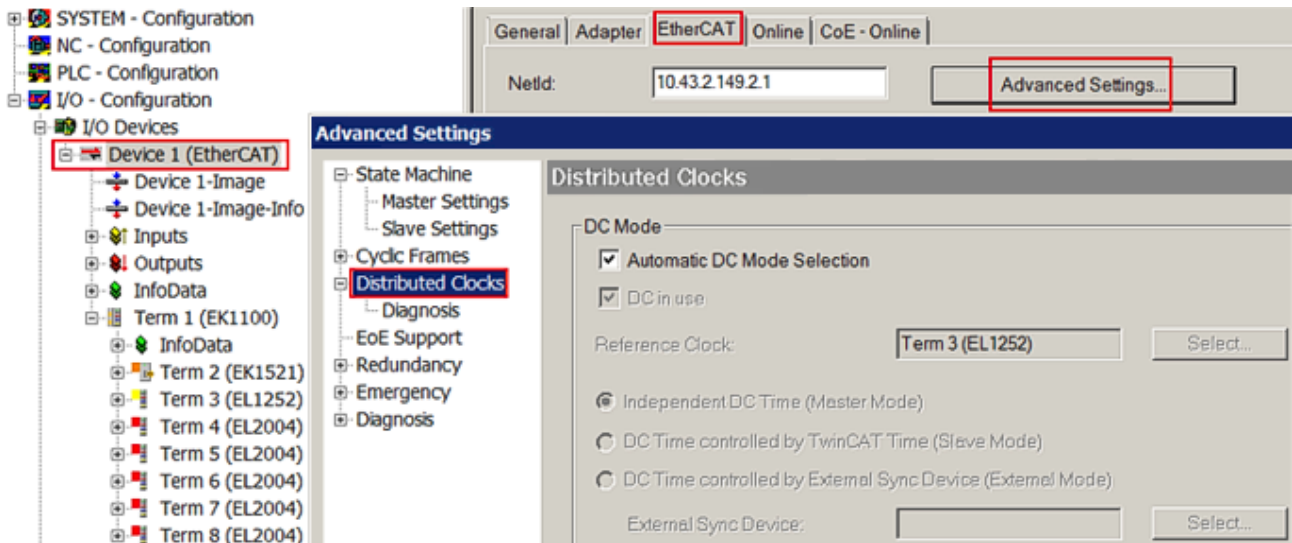

Fig. 72: Advanced Distributed Clocks settings in the EtherCAT master

The figure shows how TwinCAT selects the EL1252 as reference clock by default, since the preceding components do not support DC.

**Settings EtherCAT device**

System and infrastructure devices such as EK1100 or EK1122 couplers and junction etc. do not require Distributed Clocks to function properly. Nevertheless, it may be topologically expedient to designate the first coupler in an EtherCAT system as reference clock, for example. For this reason, from a certain level the infrastructure components are able to operate as reference clocks, based on special configuration settings.

According to the following table (*DC support from rev/firmware version*), the components support activation of distributed clocks:

Device	XML revision in the configuration	Serial number of the component
BK1150	from BK1150-0000-0016	from firmware 01: xxxx01yy
CU1128	from CU1128-0000-0000	from firmware 00: xxxx00yy
EK1100	from EK1100-0000-0017	from firmware 06: xxxx06yy
EK1101	from EK1101-0000-0017	from firmware 01: xxxx01yy
EK1501	from EK1501-0000-0017	from firmware 01: xxxx01yy
EK1501-0010	from EK1501-0010-0017	from firmware 02: xxxx02yy
EK1122	from EK1122-0000-0017	from firmware 01: xxxx02yy
EK1521	from EK1521-0000-0018	from firmware 03: xxxx03yy
EK1541	from EK1541-0000-0016	from firmware 01: xxxx01yy
EK1561	from EK1561-0000-0016	from firmware 01: xxxx01yy
EK1521-0010	from EK1521-0010-0018	from firmware 03: xxxx03yy
EK1814	from EK1814-0000-0016	from firmware 00: xxxx00yy

To ensure that TwinCAT uses such a component as DC reference clock, a manual intervention during the configuration setup is required, as shown here using the EK1100 as an example.

The checkboxes “Cyclic Mode Enable” and “Use as potential Reference Clock” must be set.

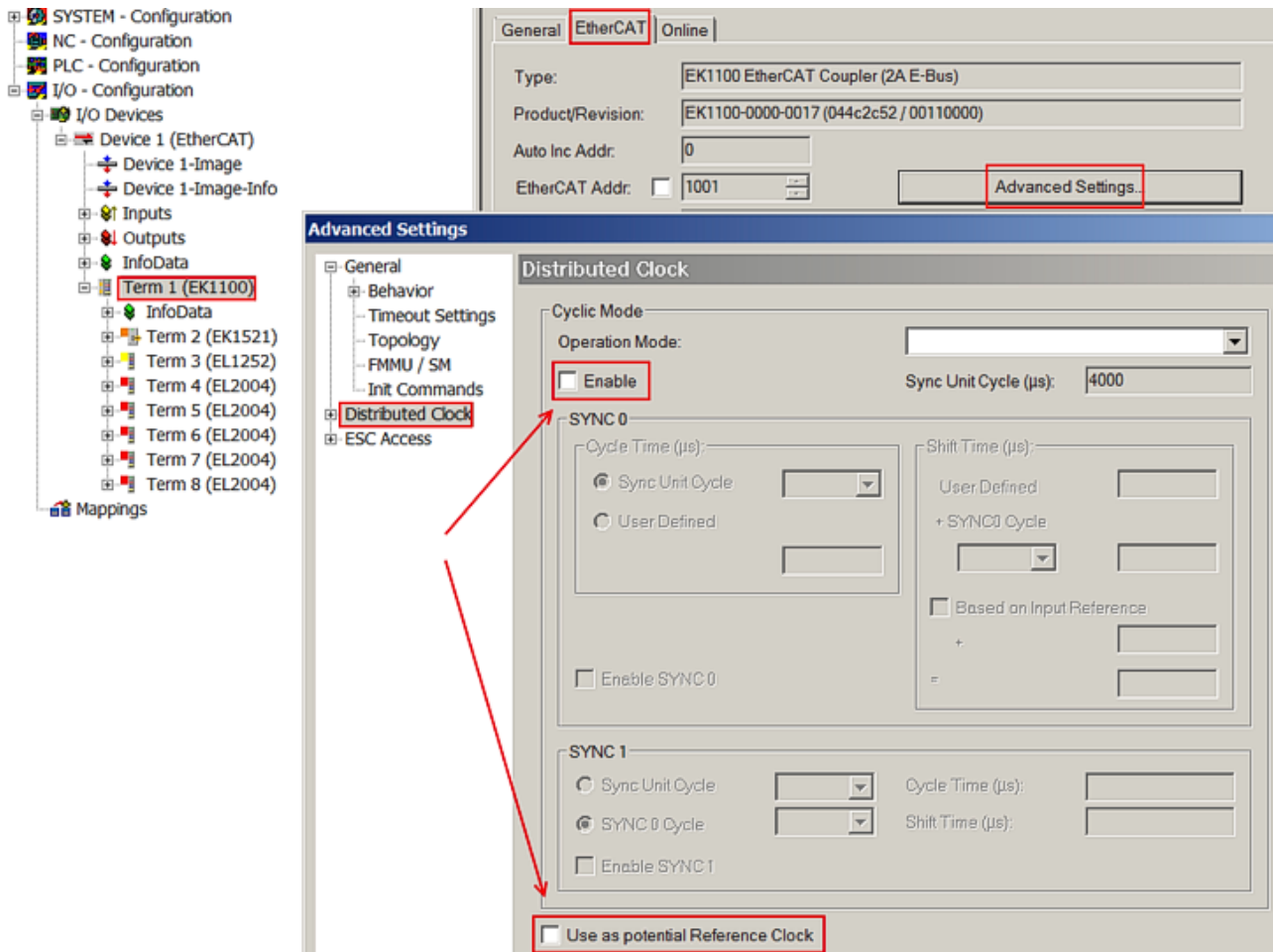

Fig. 73: TwinCAT setting for using this component as reference clock

**i Activation of Distributed Clocks support**

The (synchronization) procedure described here is only successful for the components described above. The checkboxes can be set for other components, too, although the hardware does not support this function, unless specified in the respective documentation. In particular, please note that after commissioning the component may not be replaced with a previous version without DC support.

## 7 Appendix

### 7.1 Safety instructions and behavioral rules for Class 1 laser

#### ⚠ CAUTION

**Class 1 laser product – danger of accident due to glare!**



The following laser-specific behavioral rules are to be followed for the Class 1 laser products described in this document:

- The laser beam may not be directed toward persons, since accidents may be caused by glare.
- Do not look into the direct or reflected beam.
- If laser radiation meets the eye, the eyes must be consciously closed and the head turned away from the beam immediately.
- When using the laser, no optical instruments may be used to view the radiation source, since this can lead to exposure limit values being exceeded.
- Manipulations (modifications) of the laser device are not permitted.

### 7.2 Firmware compatibility

The EK1122 and EK15xx Couplers have no firmware.

### 7.3 Firmware Update EL/ES/EM/ELM/EP/EPP/ERPxxxx

This section describes the device update for Beckhoff EtherCAT slaves from the EL/ES, ELM, EM, EK, EP, EPP and ERP series. A firmware update should only be carried out after consultation with Beckhoff support.

#### NOTICE

##### **Only use TwinCAT 3 software!**

A firmware update of Beckhoff IO devices must only be performed with a TwinCAT 3 installation. It is recommended to build as up-to-date as possible, available for free download on the [Beckhoff website](#).

To update the firmware, TwinCAT can be operated in the so-called FreeRun mode, a paid license is not required.

The device to be updated can usually remain in the installation location, but TwinCAT has to be operated in the FreeRun. Please make sure that EtherCAT communication is trouble-free (no LostFrames etc.).

Other EtherCAT master software, such as the EtherCAT Configurator, should not be used, as they may not support the complexities of updating firmware, EEPROM and other device components.

#### **Storage locations**

An EtherCAT slave stores operating data in up to three locations:

- Each EtherCAT slave has a device description, consisting of identity (name, product code), timing specifications, communication settings, etc.  
This device description (ESI; EtherCAT Slave Information) can be downloaded from the Beckhoff website in the download area as a [zip file](#) and used in EtherCAT masters for offline configuration, e.g.

in TwinCAT.

Above all, each EtherCAT slave carries its device description (ESI) electronically readable in a local memory chip, the so-called **ESI EEPROM**. When the slave is switched on, this description is loaded locally in the slave and informs it of its communication configuration; on the other hand, the EtherCAT master can identify the slave in this way and, among other things, set up the EtherCAT communication accordingly.

### NOTICE

#### Application-specific writing of the ESI-EEPROM

The ESI is developed by the device manufacturer according to ETG standard and released for the corresponding product.

- Meaning for the ESI file: Modification on the application side (i.e. by the user) is not permitted.  
 - Meaning for the ESI EEPROM: Even if a writeability is technically given, the ESI parts in the EEPROM and possibly still existing free memory areas must not be changed beyond the normal update process. Especially for cyclic memory processes (operating hours counter etc.), dedicated memory products such as EL6080 or IPC's own NOVRAM must be used.

- Depending on functionality and performance EtherCAT slaves have one or several local controllers for processing I/O data. The corresponding program is the so-called **firmware** in \*.efw format.
- In some EtherCAT slaves the EtherCAT communication may also be integrated in these controllers. In this case the controller is usually a so-called **FPGA** chip with \*.rbf firmware.

Customers can access the data via the EtherCAT fieldbus and its communication mechanisms. Acyclic mailbox communication or register access to the ESC is used for updating or reading of these data.

The TwinCAT System Manager offers mechanisms for programming all three parts with new data, if the slave is set up for this purpose. Generally the slave does not check whether the new data are suitable, i.e. it may no longer be able to operate if the data are unsuitable.

#### Simplified update by bundle firmware

The update using so-called **bundle firmware** is more convenient: in this case the controller firmware and the ESI description are combined in a \*.efw file; during the update both the firmware and the ESI are changed in the terminal. For this to happen it is necessary

- for the firmware to be in a packed format: recognizable by the file name, which also contains the revision number, e.g. ELxxx-xxx\_REV0016\_SW01.efw
- for password=1 to be entered in the download dialog. If password=0 (default setting) only the firmware update is carried out, without an ESI update.
- for the device to support this function. The function usually cannot be retrofitted; it is a component of many new developments from year of manufacture 2016.

Following the update, its success should be verified

- ESI/Revision: e.g. by means of an online scan in TwinCAT ConfigMode/FreeRun – this is a convenient way to determine the revision
- Firmware: e.g. by looking in the online CoE of the device

### NOTICE

#### Risk of damage to the device!

✓ Note the following when downloading new device files

a) Firmware downloads to an EtherCAT device must not be interrupted

b) Flawless EtherCAT communication must be ensured. CRC errors or LostFrames must be avoided.

c) The power supply must adequately dimensioned. The signal level must meet the specification.

⇒ In the event of malfunctions during the update process the EtherCAT device may become unusable and require re-commissioning by the manufacturer.

### 7.3.1 Device description ESI file/XML

#### NOTICE

#### Attention regarding update of the ESI description/EEPROM

Some slaves have stored calibration and configuration data from the production in the EEPROM. These are irretrievably overwritten during an update.

The ESI device description is stored locally on the slave and loaded on start-up. Each device description has a unique identifier consisting of slave name (9 characters/digits) and a revision number (4 digits). Each slave configured in the System Manager shows its identifier in the EtherCAT tab:

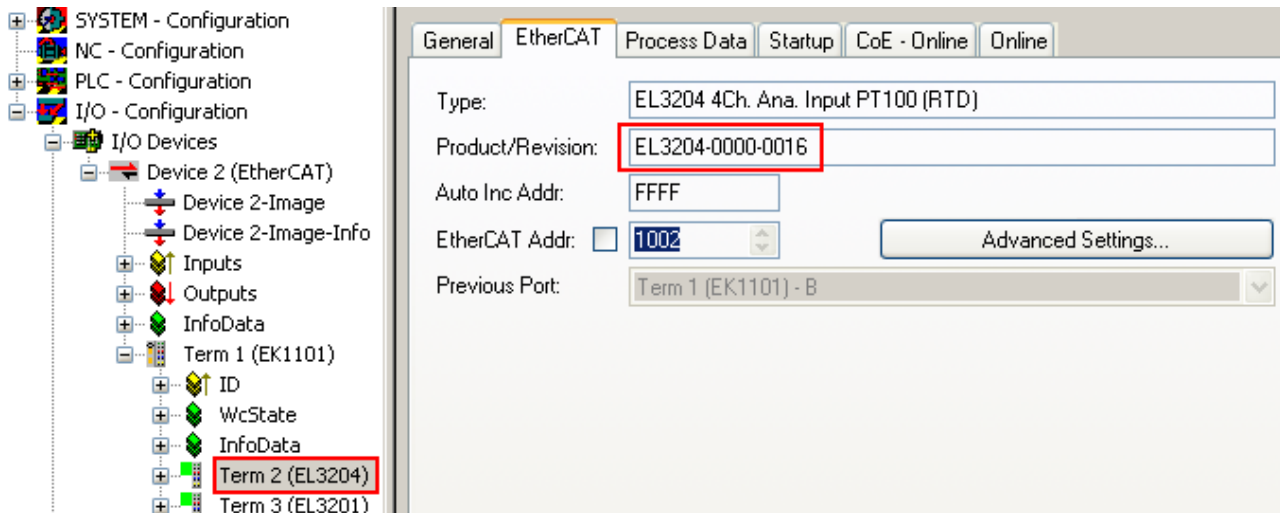

Fig. 74: Device identifier consisting of name EL3204-0000 and revision -0016

The configured identifier must be compatible with the actual device description used as hardware, i.e. the description which the slave has loaded on start-up (in this case EL3204). Normally the configured revision must be the same or lower than that actually present in the terminal network.

For further information on this, please refer to the [EtherCAT system documentation](#).

#### **i** Update of XML/ESI description

The device revision is closely linked to the firmware and hardware used. Incompatible combinations lead to malfunctions or even final shutdown of the device. Corresponding updates should only be carried out in consultation with Beckhoff support.

#### Display of ESI slave identifier

The simplest way to ascertain compliance of configured and actual device description is to scan the EtherCAT boxes in TwinCAT mode Config/FreeRun:

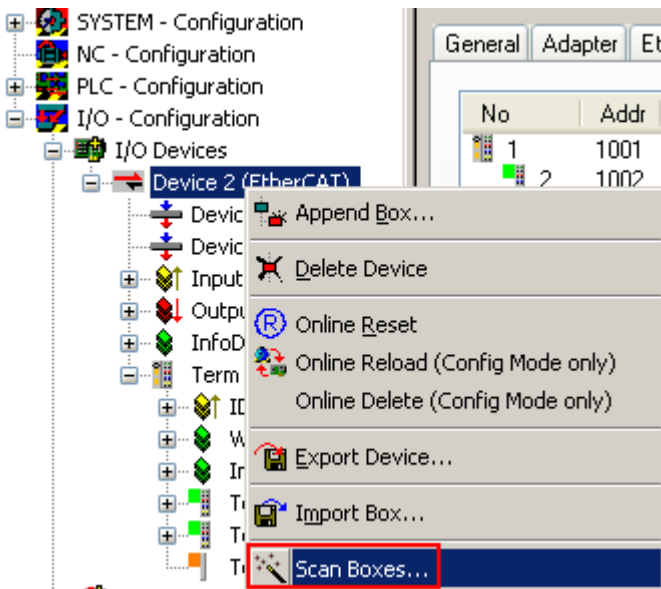

Fig. 75: Scan the subordinate field by right-clicking on the EtherCAT device

If the found field matches the configured field, the display shows



Fig. 76: Configuration is identical

otherwise a change dialog appears for entering the actual data in the configuration.

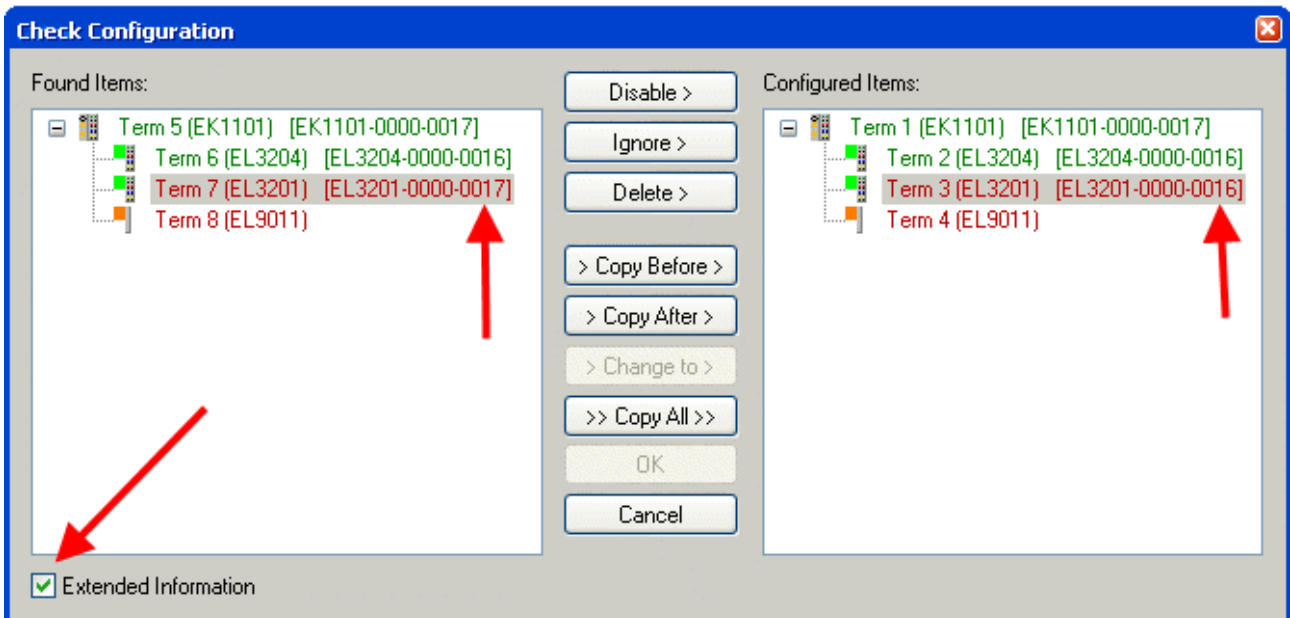

Fig. 77: Change dialog

In this example in Fig. *Change dialog*, an EL3201-0000-0017 was found, while an EL3201-0000-0016 was configured. In this case the configuration can be adapted with the *Copy Before* button. The *Extended Information* checkbox must be set in order to display the revision.

## Changing the ESI slave identifier

The ESI/EEPROM identifier can be updated as follows under TwinCAT:

- Trouble-free EtherCAT communication must be established with the slave.
- The state of the slave is irrelevant.
- Right-clicking on the slave in the online display opens the *EEPROM Update* dialog, Fig. *EEPROM Update*

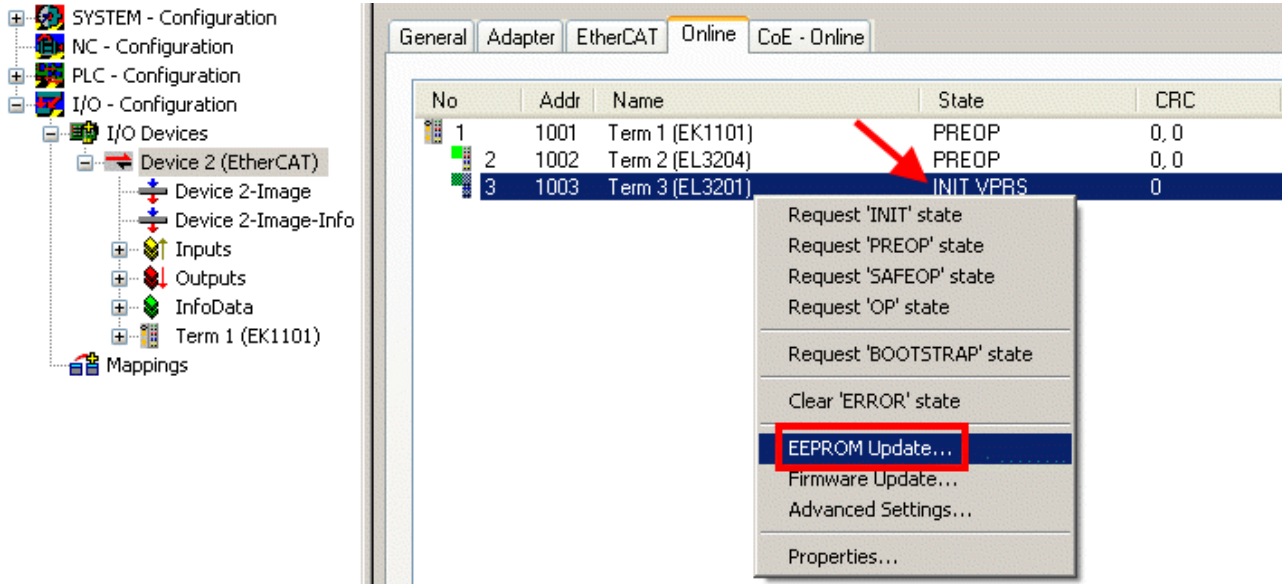

Fig. 78: EEPROM Update

The new ESI description is selected in the following dialog, see Fig. *Selecting the new ESI*. The checkbox *Show Hidden Devices* also displays older, normally hidden versions of a slave.

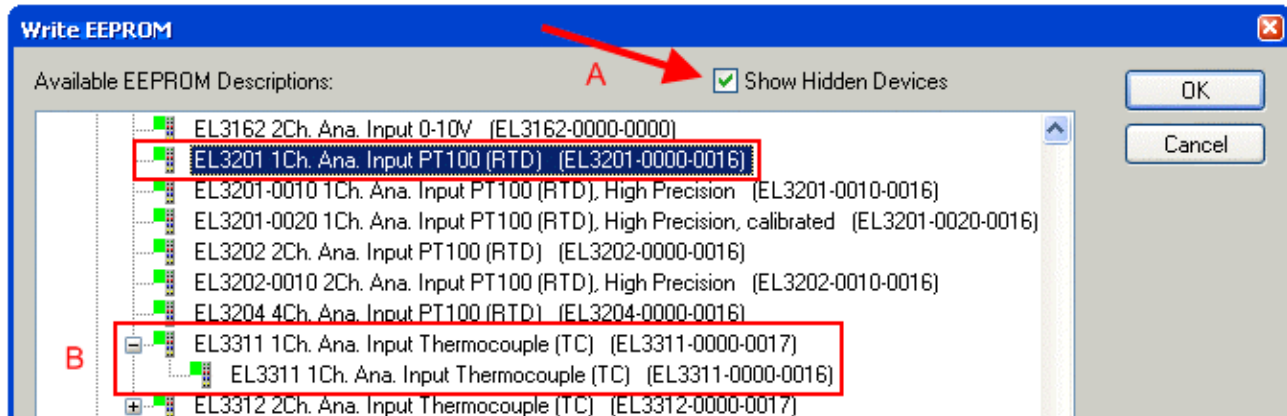

Fig. 79: Selecting the new ESI

A progress bar in the System Manager shows the progress. Data are first written, then verified.

### ● The change only takes effect after a restart.

**i** Most EtherCAT devices read a modified ESI description immediately or after startup from the INIT. Some communication settings such as distributed clocks are only read during power-on. The EtherCAT slave therefore has to be switched off briefly in order for the change to take effect.



### 7.3.2 Firmware explanation

#### Determining the firmware version

#### Determining the version via the System Manager

The TwinCAT System Manager shows the version of the controller firmware if the master can access the slave online. Click on the E-Bus Terminal whose controller firmware you want to check (in the example terminal 2 (EL3204)) and select the tab *CoE Online* (CAN over EtherCAT).

#### ● CoE Online and Offline CoE



Two CoE directories are available:

- **online:** This is offered in the EtherCAT slave by the controller, if the EtherCAT slave supports this. This CoE directory can only be displayed if a slave is connected and operational.
- **offline:** The EtherCAT Slave Information ESI/XML may contain the default content of the CoE. This CoE directory can only be displayed if it is included in the ESI (e.g. "Beckhoff EL5xxx.xml").

The Advanced button must be used for switching between the two views.

In Fig. *Display of EL3204 firmware version* the firmware version of the selected EL3204 is shown as 03 in CoE entry 0x100A.

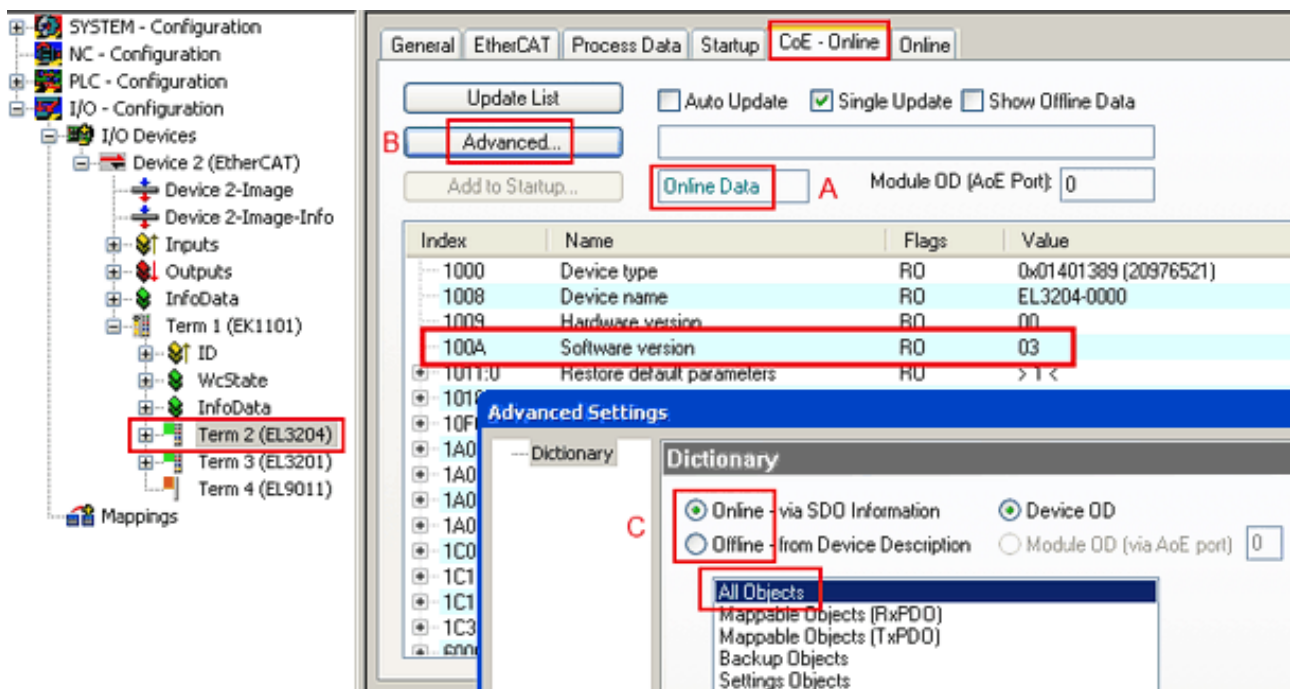

Fig. 80: Display of EL3204 firmware version

In (A) TwinCAT 2.11 shows that the Online CoE directory is currently displayed. If this is not the case, the Online directory can be loaded via the *Online* option in Advanced Settings (B) and double-clicking on *AllObjects*.

### 7.3.3 Updating controller firmware \*.efw

#### ● CoE directory



The Online CoE directory is managed by the controller and stored in a dedicated EEPROM, which is generally not changed during a firmware update.

Switch to the *Online* tab to update the controller firmware of a slave, see Fig. *Firmware Update*.

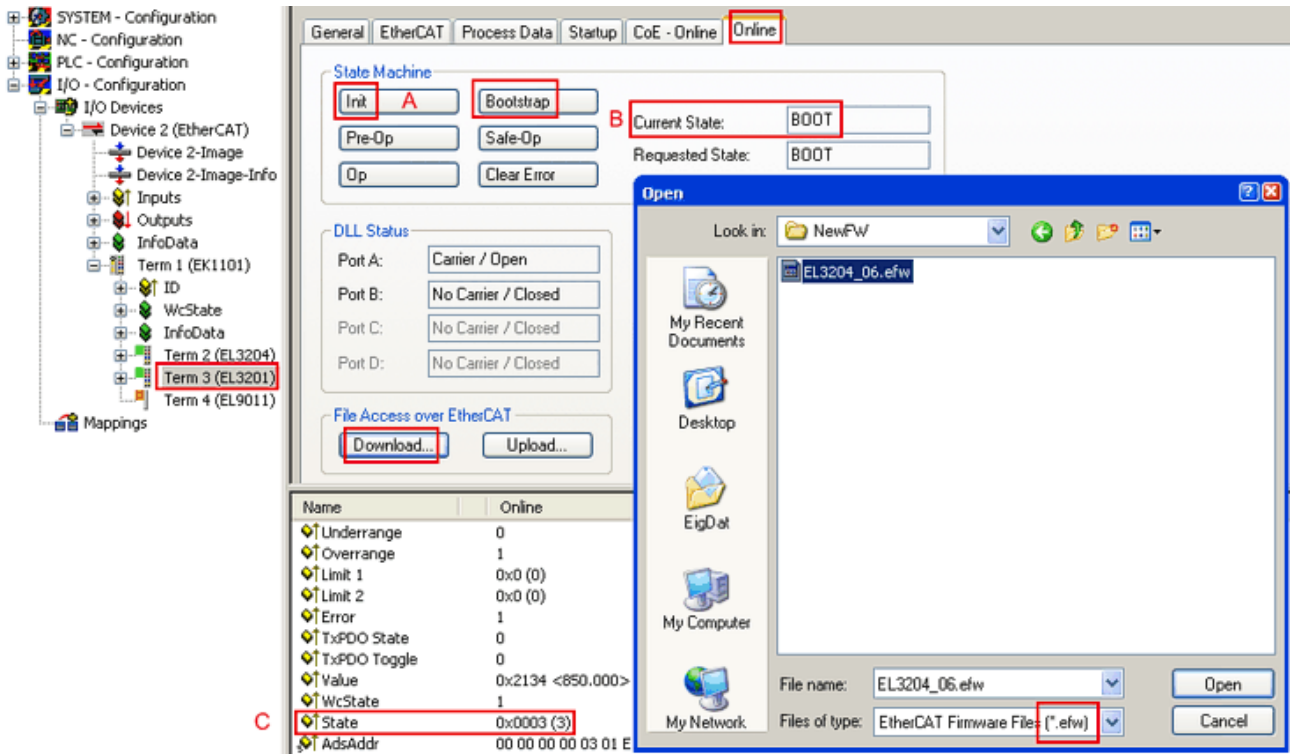
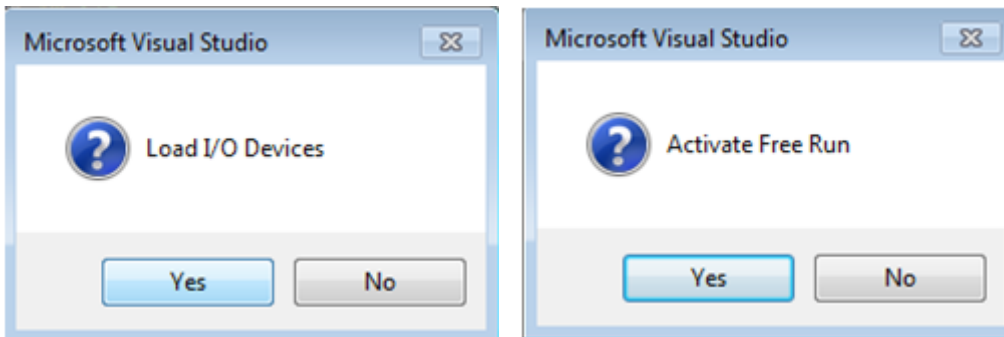

Fig. 81: Firmware Update

Proceed as follows, unless instructed otherwise by Beckhoff support. Valid for TwinCAT 2 and 3 as EtherCAT master.

- Switch TwinCAT system to ConfigMode/FreeRun with cycle time  $\geq 1$  ms (default in ConfigMode is 4 ms). A FW-Update during real time operation is not recommended.



- Switch EtherCAT Master to PreOP

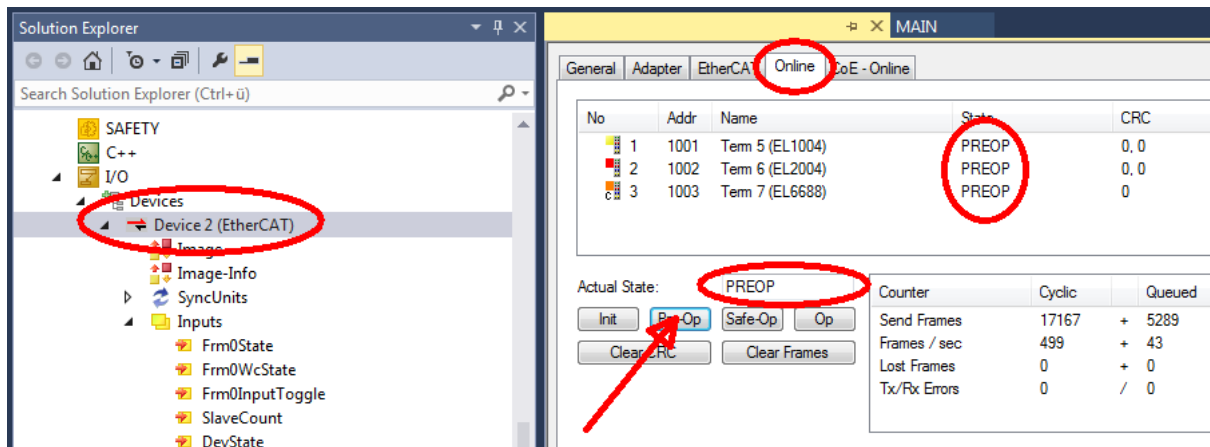

- Switch slave to INIT (A)
- Switch slave to BOOTSTRAP

- Check the current status (B, C)
- Download the new \*efw file (wait until it ends). A password will not be necessary usually.

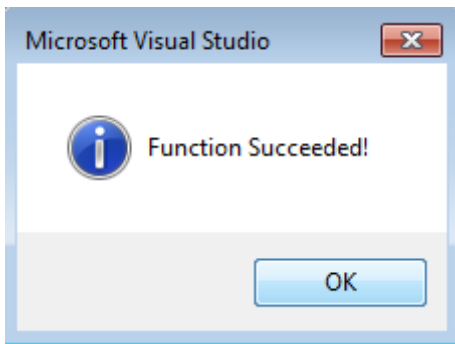

- After the download switch to INIT, then PreOP
- Switch off the slave briefly (don't pull under voltage!)
- Check within CoE 0x100A, if the FW status was correctly overtaken.

### 7.3.4 FPGA firmware \*.rbf

If an FPGA chip deals with the EtherCAT communication an update may be accomplished via an \*.rbf file.

- Controller firmware for processing I/O signals
- FPGA firmware for EtherCAT communication (only for terminals with FPGA)

The firmware version number included in the terminal serial number contains both firmware components. If one of these firmware components is modified this version number is updated.

#### Determining the version via the System Manager

The TwinCAT System Manager indicates the FPGA firmware version. Click on the Ethernet card of your EtherCAT strand (Device 2 in the example) and select the *Online* tab.

The *Reg:0002* column indicates the firmware version of the individual EtherCAT devices in hexadecimal and decimal representation.

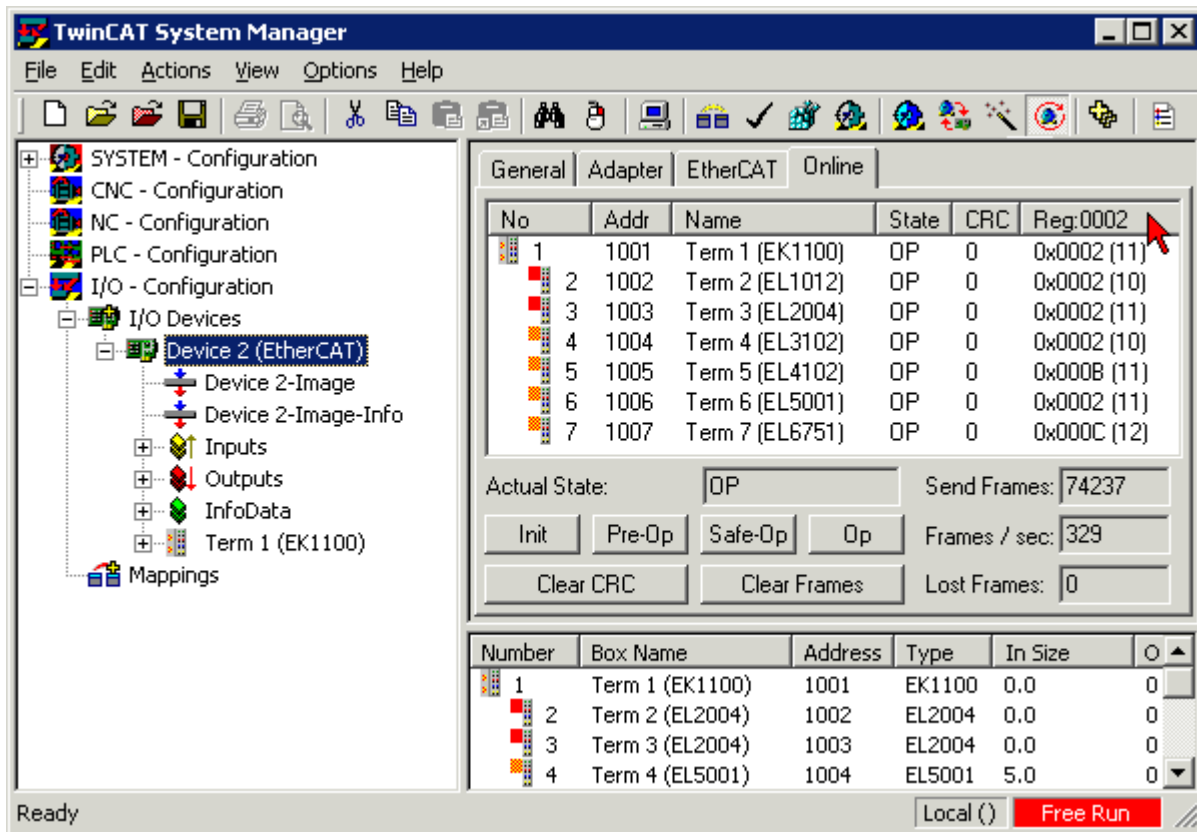
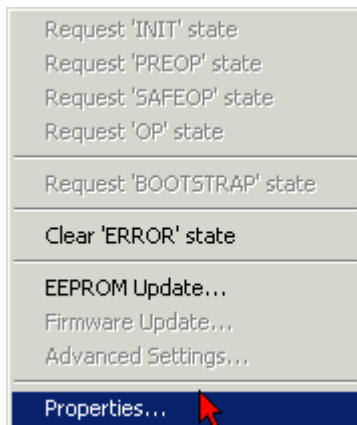

Fig. 82: FPGA firmware version definition

If the column *Reg:0002* is not displayed, right-click the table header and select *Properties* in the context menu.

Fig. 83: Context menu *Properties*

The *Advanced Settings* dialog appears where the columns to be displayed can be selected. Under *Diagnosis/Online View* select the *'0002 ETxxxx Build'* check box in order to activate the FPGA firmware version display.

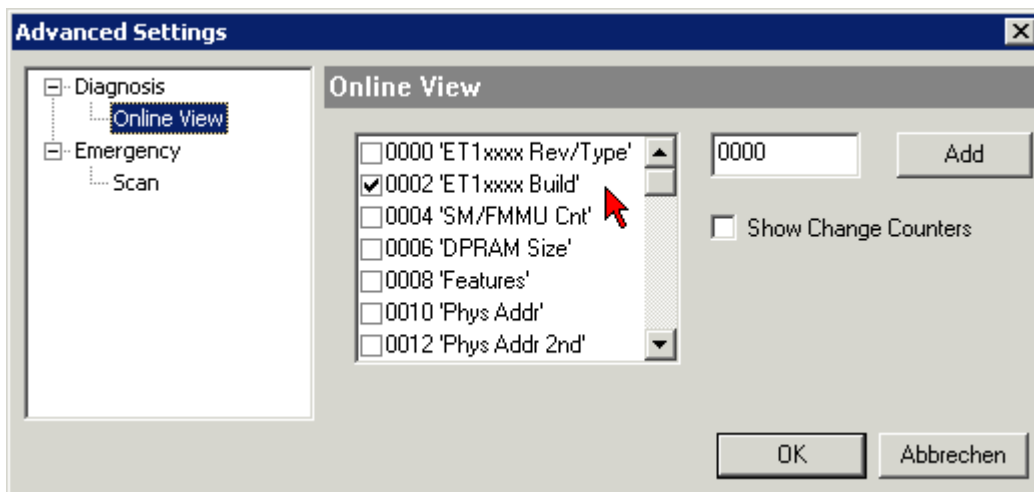

Fig. 84: Dialog *Advanced Settings*

### Update

For updating the FPGA firmware

- of an EtherCAT coupler the coupler must have FPGA firmware version 11 or higher;
- of an E-Bus Terminal the terminal must have FPGA firmware version 10 or higher.

Older firmware versions can only be updated by the manufacturer!

### Updating an EtherCAT device

The following sequence order have to be met if no other specifications are given (e.g. by the Beckhoff support):

- Switch TwinCAT system to ConfigMode/FreeRun with cycle time  $\geq 1$  ms (default in ConfigMode is 4 ms). A FW-Update during real time operation is not recommended.

- In the TwinCAT System Manager select the terminal for which the FPGA firmware is to be updated (in the example: Terminal 5: EL5001) and click the *Advanced Settings* button in the *EtherCAT* tab:

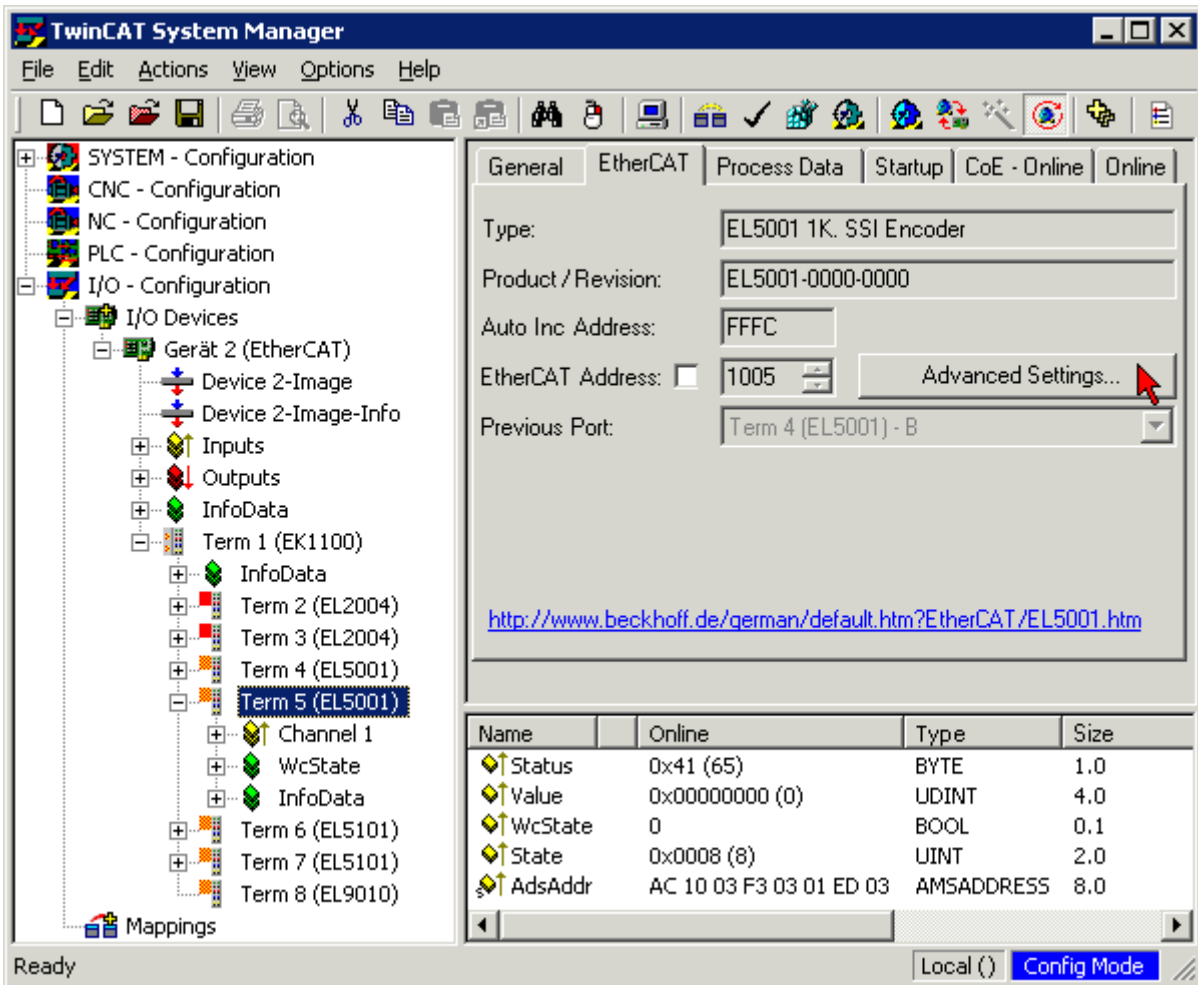

- The *Advanced Settings* dialog appears. Under *ESC Access/E<sup>2</sup>PROM/FPGA* click on *Write FPGA* button:

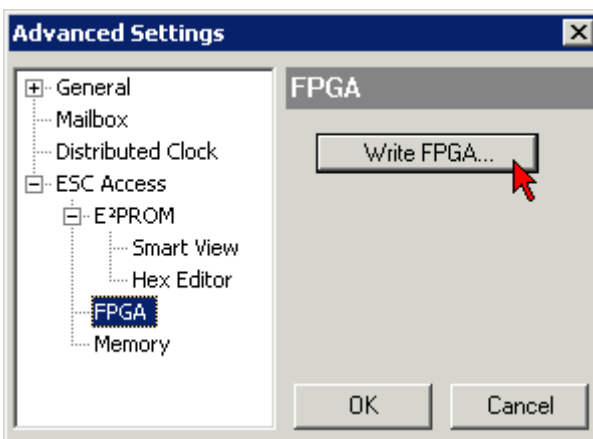

- Select the file (\*.rbf) with the new FPGA firmware, and transfer it to the EtherCAT device:

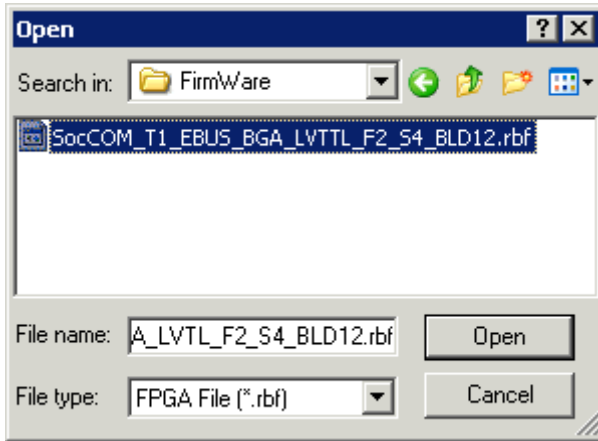

- Wait until download ends
- Switch slave current less for a short time (don't pull under voltage!). In order to activate the new FPGA firmware a restart (switching the power supply off and on again) of the EtherCAT device is required.
- Check the new FPGA status

**NOTICE**

**Risk of damage to the device!**

A download of firmware to an EtherCAT device must not be interrupted in any case! If you interrupt this process by switching off power supply or disconnecting the Ethernet link, the EtherCAT device can only be recommissioned by the manufacturer!

### 7.3.5 Simultaneous updating of several EtherCAT devices

The firmware and ESI descriptions of several devices can be updated simultaneously, provided the devices have the same firmware file/ESI.

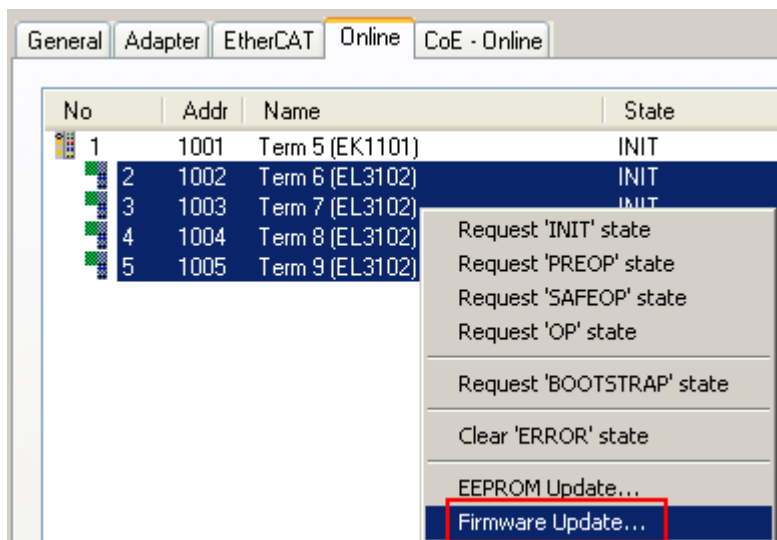

Fig. 85: Multiple selection and firmware update

Select the required slaves and carry out the firmware update in BOOTSTRAP mode as described above.

## 7.4 Support and Service

Beckhoff and their partners around the world offer comprehensive support and service, making available fast and competent assistance with all questions related to Beckhoff products and system solutions.

### Beckhoff's branch offices and representatives

Please contact your Beckhoff branch office or representative for local support and service on Beckhoff products!

The addresses of Beckhoff's branch offices and representatives round the world can be found on her internet pages: [www.beckhoff.com](http://www.beckhoff.com)

You will also find further documentation for Beckhoff components there.

### Support

The Beckhoff Support offers you comprehensive technical assistance, helping you not only with the application of individual Beckhoff products, but also with other, wide-ranging services:

- support
- design, programming and commissioning of complex automation systems
- and extensive training program for Beckhoff system components

Hotline: +49 5246 963 157  
e-mail: [support@beckhoff.com](mailto:support@beckhoff.com)  
web: [www.beckhoff.com/support](http://www.beckhoff.com/support)

### Service

The Beckhoff Service Center supports you in all matters of after-sales service:

- on-site service
- repair service
- spare parts service
- hotline service

Hotline: +49 5246 963 460  
e-mail: [service@beckhoff.com](mailto:service@beckhoff.com)  
web: [www.beckhoff.com/service](http://www.beckhoff.com/service)

### Headquarters Germany

Beckhoff Automation GmbH & Co. KG

Hülshorstweg 20  
33415 Verl  
Germany

Phone: +49 5246 963 0  
e-mail: [info@beckhoff.com](mailto:info@beckhoff.com)  
web: [www.beckhoff.com](http://www.beckhoff.com)





More Information:  
[www.beckhoff.com/ek1xxx](http://www.beckhoff.com/ek1xxx)

Beckhoff Automation GmbH & Co. KG  
Hülshorstweg 20  
33415 Verl  
Germany  
Phone: +49 5246 9630  
[info@beckhoff.com](mailto:info@beckhoff.com)  
[www.beckhoff.com](http://www.beckhoff.com)

