

SGWEIGH

检重秤 高速分选秤 多级分选秤 静态检重秤

Shanghai Shigan Industrial Co., Ltd.

上海实干实业有限公司

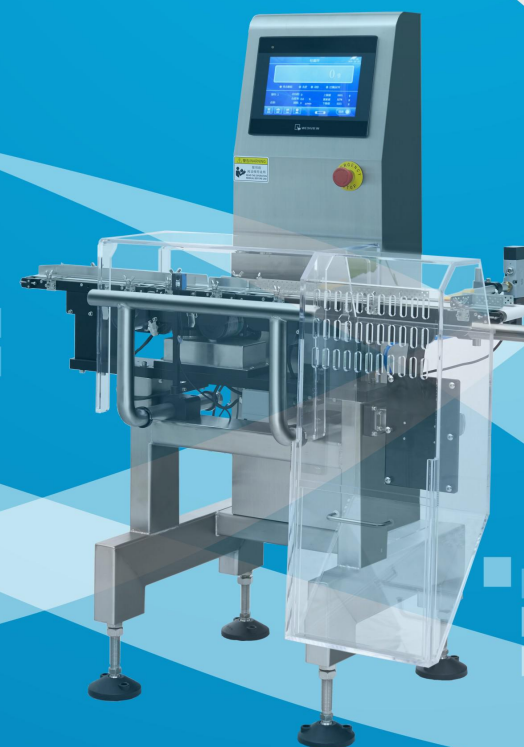

上海实干实业有限公司
Shanghai Shigan Industrial Co., Ltd.

地址：上海市松江区新桥镇九新公路2888号
电话：021-67689703
网址：www.sgjianzhongji.com

上海实干实业有限公司
Shanghai Shigan Industrial Co., Ltd.



Company Profile 公司简介

上海实干实业有限公司是一家集科技、研发、生产销售为一体的高科技企业，公司拥有多年检重领域经验，以卓越的设计能力，完善的工艺控制和可靠稳定的检测手段，向客户提供高性价比的检重秤，多级分选秤，以及相应的辅助配套设备。

产品质量稳定可靠，部分型号产品已经能够超越同类进口产品，并且远销世界各地，深受广大用户及经销商的喜爱和好评。公司始终坚持“质量为王、持续创新”的经营方针，以“信守承诺、用户至上”的企业宗旨，与广大用户精诚合作、欢迎新老客户光临惠顾。

Shanghai Shigan Industrial Co., Ltd. is a hi-tech integrated enterprise with science and technology, processing and sales. We are specialized in checkweigher for years in this field, providing customers cost-effective checkweigher, Multi-grades weight sorting scale and related auxiliary equipment by excellent design, perfect process control, stable and reliable detection methods.

Stable and reliable quality, Several series had already exceeded the similar imported products, export all over the world, and they are loved and praised by customers and distributors in the market.

The company always adheres to the business principle of "Quality is king and continuous innovation", with the corporate tenet of "keeping promises and customers first", cooperates with customers sincerely and welcomes new and old customers to visit our factory.



>> SG-100

▶ 功能特点 Features

- ① 触摸屏人机对话
User-friendly operating system.
- ② 中英文操作界面
Chinese-English interface.
- ③ 重量补偿功能
Weight of products can be compensated
- ④ 柱状图和曲线图用来客户分析产品合格率
Product qualification ratio can be showed in line graphs and bar charts.
- ⑤ 二级操作权限管理，支持自设密码
Two types of changeable password and login user rights for operators and administrator respectively.
- ⑥ 可100个产品配方预设存储
100 kinds of data can be stored with strong data statistics function.
- ⑦ 不合格产品多种剔除方式，支持不合格停机功能。
Support the function of non-qualified stop and multi-methods of rejection.



▶ 选配 Optional

- ① U盘接口 USB Port
- ② RS485 接口/喷码机通信接口
RS485 Port/Inkjet printer communication interface
- ③ 声光报警灯
Sound-light tri-colour alarming lamp

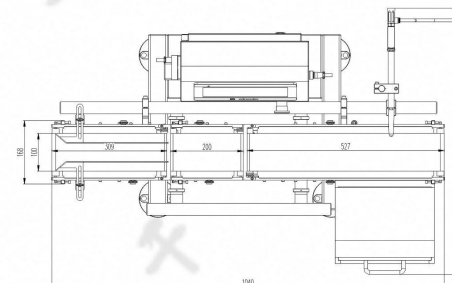

型号: Type	SG-100
称重范围: Weighing scope	2-300g
产品限制: Restrictions of product	L:100 W:100 H:2-150(mm)
分选精度: Accuracy	±0.05g (视产品) (±0.05g Depends on products)
分度值: Division Scale	0.01g
皮带速度: Belt speed	0-80m/min
最高速度: Highest speed	300pcs/min
皮带宽度: Belt Width	100mm
机器自重: Weight of Machine	70Kg
电源: Power Supply	AC 220V±10% 50HZ
功率: Power	≈100w
主要材质: Main Material	SU304 不锈钢 (SUS304 Stainless Steel)

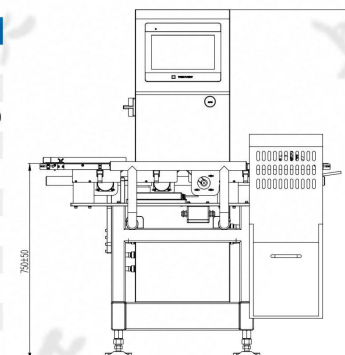

>> SG-150

▶ 功能特点Features

- ◎ 触摸屏人机对话
User-friendly operating system.
- ◎ 中英文操作界面
Chinese-English interface.
- ◎ 重量补偿功能
Weight of products can be compensated
- ◎ 柱状图和曲线图用来客户分析产品合格率
Product qualification ratio can be showed in line graphs and bar charts.
- ◎ 二级操作权限管理, 支持自设密码
Two types of changeable password and login user rights for operators and administrator respectively.
- ◎ 可 100 个产品配方预设存储
100 kinds of data can be stored with strong data statistics function.
- ◎ 不合格产品多种剔除方式, 支持不合格停机功能。
Support the function of non-qualified stop and multi-methods of rejection.

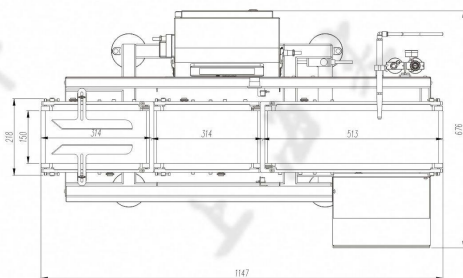

▶ 选配Optional

- ◎ U 盘接口 USB Port
- ◎ RS485 接口/喷码机通信接口
RS485 Port/Inkjet printer communication interface
- ◎ 声光报警灯
Sound-light tri-colour alarming lamp

型号:Type	SG-150
称重范围:Weighing scope	3-500g
产品限制:Restrictions of product	L:200 W:150 H:3-200(mm)
分选精度:Accuracy	±0.1g (视产品) (±0.1g Depends on products)
分度值:Division Scale	0.1g
皮带速度:Belt speed	0-65m/min
最高速度:Highest speed	150pcs/min
皮带宽度:Belt Width	150mm
机器自重:Weight of Machine	60Kg
电源:Power Supply	AC 220V±10% 50HZ
功率:Power	≈100w
主要材质:Main Material	SU304 不锈钢 (SUS304 Stainless Steel)

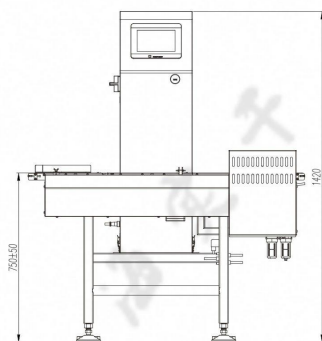

>> SG-150H

▶ 功能特点Features

- ◎ 触摸屏人机对话
User-friendly operating system.
- ◎ 中英文操作界面
Chinese-English interface.
- ◎ 重量补偿功能
Weight of products can be compensated
- ◎ 柱状图和曲线图用来客户分析产品合格率
Product qualification ratio can be showed in line graphs and bar charts.
- ◎ 二级操作权限管理, 支持自设密码
Two types of changeable password and login user rights for operators and administrator respectively.
- ◎ 可 100 个产品配方预设存储
100 kinds of data can be stored with strong data statistics function.
- ◎ 不合格产品多种剔除方式, 支持不合格停机功能。
Support the function of non-qualified stop and multi-methods of rejection.

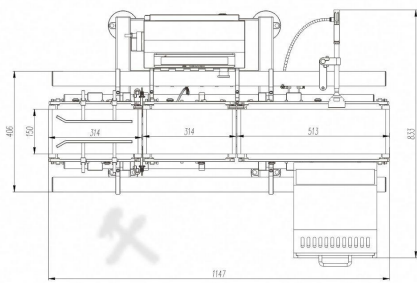

▶ 选配Optional

- ◎ U 盘接口 USB Port
- ◎ RS485 接口/喷码机通信接口
RS485 Port/Inkjet printer communication interface
- ◎ 声光报警灯
Sound-light tri-colour alarming lamp

型号:Type	SG-150H
称重范围:Weighing scope	3-500g
产品限制:Restrictions of product	L:200 W:150 H:3-200(mm)
分选精度:Accuracy	±0.1g (视产品) (±0.1g Depends on products)
分度值:Division Scale	0.1g
皮带速度:Belt speed	0-90m/min
最高速度:Highest speed	240pcs/min
皮带宽度:Belt Width	150mm
机器自重:Weight of Machine	70Kg
电源:Power Supply	AC 220V±10% 50HZ
功率:Power	≈100w
主要材质:Main Material	SU304 不锈钢 (SUS304 Stainless Steel)

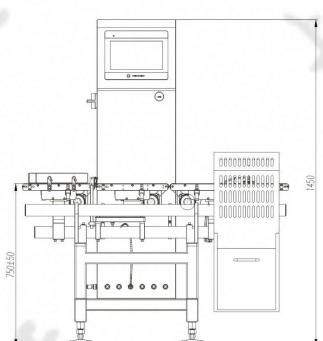

>> SG-220面膜专用Facial mask

▶ 功能特点Features

- ◎ 触摸屏人机对话
User-friendly operating system.
- ◎ 中英文操作界面
Chinese-English interface.
- ◎ 重量补偿功能
Weight of products can be compensated
- ◎ 柱状图和曲线图用来客户分析产品合格率
Product qualification ratio can be showed in line graphs and bar charts.
- ◎ 二级操作权限管理, 支持自设密码
Two types of changeable password and login user rights for operators and administrator respectively.
- ◎ 可 100 个产品配方预设存储
100 kinds of data can be stored with strong data statistics function.
- ◎ 不合格产品多种剔除方式, 支持不合格停机功能。
Support the function of non-qualified stop and multi-methods of rejection.



▶ 选配Optional

- ◎ U 盘接口 USB Port
- ◎ RS485 接口/喷码机通信接口
RS485 Port/Inkjet printer communication interface
- ◎ 声光报警灯
Sound-light tri-colour alarming lamp

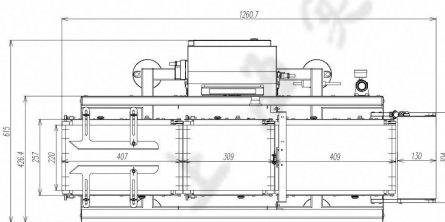

型号: Type	SG-220
称重范围: Weighing scope	5-1500g
产品限制: Restrictions of product	L:200 W:150 H:3-200(mm)
分选精度: Accuracy	±0.2g (视产品) (±0.2g Depends on products)
分度值: Division Scale	0.1g
皮带速度: Belt speed	0-60m/min
最高速度: Highest speed	100pcs/min
皮带宽度: Belt Width	220mm
机器自重: Weight of Machine	≈ 65Kg
电源: Power Supply	AC 220V±10% 50HZ
功率: Power	≈ 200w
主要材质: Main Material	SU304 不锈钢 (SUS304 Stainless Steel)

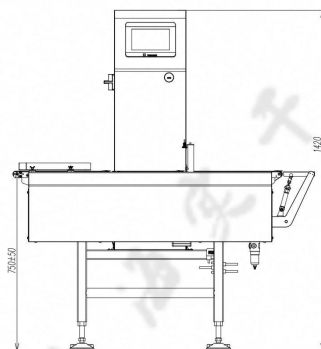

>> SG-220

▶ 功能特点Features

- ◎ 触摸屏人机对话
User-friendly operating system.
- ◎ 中英文操作界面
Chinese-English interface.
- ◎ 重量补偿功能
Weight of products can be compensated
- ◎ 柱状图和曲线图用来客户分析产品合格率
Product qualification ratio can be showed in line graphs and bar charts.
- ◎ 二级操作权限管理, 支持自设密码
Two types of changeable password and login user rights for operators and administrator respectively.
- ◎ 可 100 个产品配方预设存储
100 kinds of data can be stored with strong data statistics function.
- ◎ 不合格产品多种剔除方式, 支持不合格停机功能。
Support the function of non-qualified stop and multi-methods of rejection.



▶ 选配Optional

- ◎ U 盘接口 USB Port
- ◎ RS485 接口/喷码机通信接口
RS485 Port/Inkjet printer communication interface
- ◎ 声光报警灯
Sound-light tri-colour alarming lamp

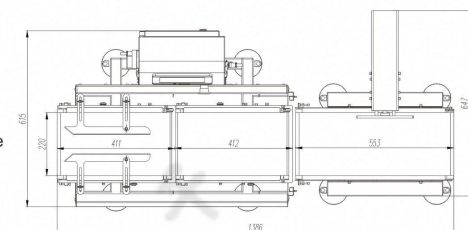

型号: Type	SG-220
称重范围: Weighing scope	5-1500g
产品限制: Restrictions of product	L:300 W:220 H:3-200(mm)
分选精度: Accuracy	±0.2g (视产品) (±0.2g Depends on products)
分度值: Division Scale	0.1g
皮带速度: Belt speed	0-60m/min
最高速度: Highest speed	100pcs/min
皮带宽度: Belt Width	220mm
机器自重: Weight of Machine	≈ 55Kg+30Kg
电源: Power Supply	AC 220V±10% 50HZ
功率: Power	≈ 200w
主要材质: Main Material	SU304 不锈钢 (SUS304 Stainless Steel)

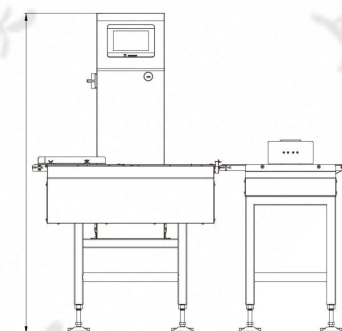

>> SG-300

▶ 功能特点Features

- ◎ 触摸屏人机对话
User-friendly operating system.
- ◎ 中英文操作界面
Chinese-English interface.
- ◎ 重量补偿功能
Weight of products can be compensated
- ◎ 柱状图和曲线图用来客户分析产品合格率
Product qualification ratio can be showed in line graphs and bar charts.
- ◎ 二级操作权限管理, 支持自设密码
Two types of changeable password and login user rights for operators and administrator respectively.
- ◎ 可 100 个产品配方预设存储
100 kinds of data can be stored with strong data statistics function.
- ◎ 不合格产品多种剔除方式, 支持不合格停机功能。
Support the function of non-qualified stop and multi-methods of rejection.



▶ 选配Optional

- ◎ U 盘接口 USB Port
- ◎ RS485 接口/喷码机通信接口
RS485 Port/Inkjet printer communication interface
- ◎ 声光报警灯
Sound-light tri-colour alarming lamp

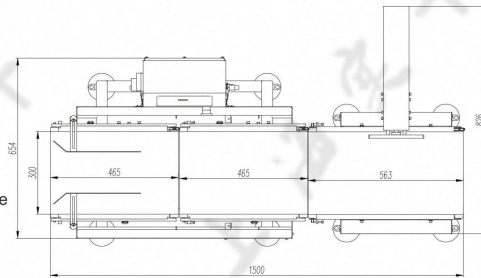

型号: Type	SG-300
称重范围: Weighing scope	5-3000g/5000g
产品限制: Restrictions of product	L:350 W:300 H:3mm以上
分选精度: Accuracy	±0.5g-1g (视产品) (±0.5g-1g Depends on products)
分度值: Division Scale	0.1g
皮带速度: Belt speed	0-60m/min
最高速度: Highest speed	80pcs/min
皮带宽度: Belt Width	300mm
机器自重: Weight of Machine	≈60Kg+35Kg
电源: Power Supply	AC 220V±10% 50HZ
功率: Power	≈200w
主要材质: Main Material	SU304 不锈钢 (SUS304 Stainless Steel)

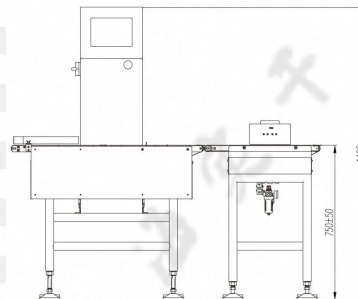

>> SG-400

▶ 功能特点Features

- ◎ 触摸屏人机对话
User-friendly operating system.
- ◎ 中英文操作界面
Chinese-English interface.
- ◎ 重量补偿功能
Weight of products can be compensated
- ◎ 柱状图和曲线图用来客户分析产品合格率
Product qualification ratio can be showed in line graphs and bar charts.
- ◎ 二级操作权限管理, 支持自设密码
Two types of changeable password and login user rights for operators and administrator respectively.
- ◎ 可 100 个产品配方预设存储
100 kinds of data can be stored with strong data statistics function.
- ◎ 不合格产品多种剔除方式, 支持不合格停机功能。
Support the function of non-qualified stop and multi-methods of rejection.



▶ 选配Optional

- ◎ U 盘接口 USB Port
- ◎ RS485 接口/喷码机通信接口
RS485 Port/Inkjet printer communication interface
- ◎ 声光报警灯
Sound-light tri-colour alarming lamp

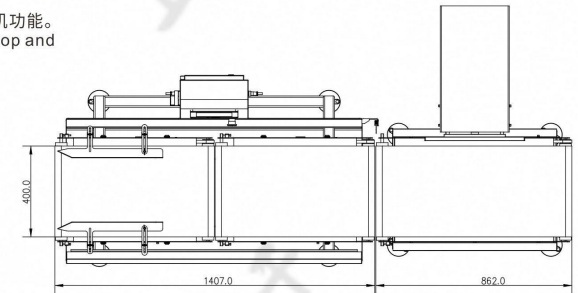

型号: Type	SG-400
称重范围: Weighing scope	10-10000g
产品限制: Restrictions of product	L:450 W:400 H:3-400mm
分选精度: Accuracy	±1-10g (视产品) (±1-10g Depends on products)
分度值: Division Scale	1g
皮带速度: Belt speed	0-60m/min
最高速度: Highest speed	50pcs/min
皮带宽度: Belt Width	400mm
机器自重: Weight of Machine	≈80Kg+44Kg
电源: Power Supply	AC 220V±10% 50HZ
功率: Power	≈300w
主要材质: Main Material	SU304 不锈钢 (SUS304 Stainless Steel)

>> SG-450

▶ 功能特点Features

- ◎ 触摸屏人机对话
User-friendly operating system.
- ◎ 中英文操作界面
Chinese-English interface.
- ◎ 重量补偿功能
Weight of products can be compensated
- ◎ 柱状图和曲线图用来客户分析产品合格率
Product qualification ratio can be showed in line graphs and bar charts.
- ◎ 二级操作权限管理, 支持自设密码
Two types of changeable password and login user rights for operators and administrator respectively.
- ◎ 可 100 个产品配方预设存储
100 kinds of data can be stored with strong data statistics function.
- ◎ 不合格产品多种剔除方式, 支持不合格停机功能。
Support the function of non-qualified stop and multi-methods of rejection.

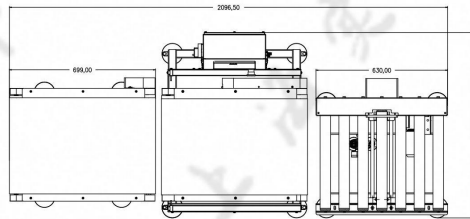

▶ 选配Optional

- ◎ U 盘接口 USB Port
- ◎ RS485 接口/喷码机通信接口
RS485 Port/Inkjet printer communication interface
- ◎ 声光报警灯
Sound-light tri-colour alarming lamp

型号:Type	SG-450
称重范围:Weighing scope	0.05-20/30Kg
产品限制:Restrictions of product	L:550 W:450 H:3-400mm
分选精度:Accuracy	±5/10g (视产品) (±5/10g Depends on products)
分度值:Division Scale	1g
皮带速度:Belt speed	0-40m/min
最高速度:Highest speed	40pcs/min
皮带宽度:Belt Width	450mm
机器自重:Weight of Machine	≈40Kg+70Kg+44Kg
电源:Power Supply	AC 220V±10% 50HZ
功率:Power	≈400w
主要材质:Main Material	SU304 不锈钢 (SUS304 Stainless Steel)

>> SG-550

▶ 功能特点Features

- ◎ 触摸屏人机对话
User-friendly operating system.
- ◎ 中英文操作界面
Chinese-English interface.
- ◎ 重量补偿功能
Weight of products can be compensated
- ◎ 柱状图和曲线图用来客户分析产品合格率
Product qualification ratio can be showed in line graphs and bar charts.
- ◎ 二级操作权限管理, 支持自设密码
Two types of changeable password and login user rights for operators and administrator respectively.
- ◎ 可 100 个产品配方预设存储
100 kinds of data can be stored with strong data statistics function.
- ◎ 不合格产品多种剔除方式, 支持不合格停机功能。
Support the function of non-qualified stop and multi-methods of rejection.



▶ 选配Optional

- ◎ U 盘接口 USB Port
- ◎ RS485 接口/喷码机通信接口
RS485 Port/Inkjet printer communication interface
- ◎ 声光报警灯
Sound-light tri-colour alarming lamp

型号:Type	SG-550
称重范围:Weighing scope	0.05-50Kg
产品限制:Restrictions of product	L:800 W:550 H:3-400mm
分选精度:Accuracy	±20g (视产品) (±20g Depends on products)
分度值:Division Scale	1g
皮带速度:Belt speed	0-40m/min
最高速度:Highest speed	30pcs/min
皮带宽度:Belt Width	550mm
机器自重:Weight of Machine	≈100+50Kg
电源:Power Supply	AC 220V±10% 50HZ
功率:Power	≈500w
主要材质:Main Material	SU304 不锈钢 (SUS304 Stainless Steel)

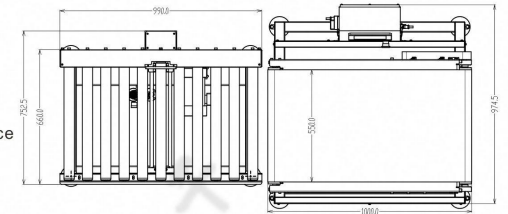

>> SG-D300

▶ 功能特点Features

- ◎ 加强型不锈钢机架;全面防水设计
Enhanced stainless steel rack; full waterproof design.
- ◎ 高精度数字称重传感器,采用高速数字滤波处理和自动零点跟踪功能。
High-precision digital load cell adopts high-speed digital filter processing and automatic zero tracking.
- ◎ 系统根据产品选择自动调整速度
The system automatically adjusts the speed according to the product selection
- ◎ 产品特性的自动学习功能
Product features automatic learning function
- ◎ 50组产品预设;全面的产品编辑和储存
50 sets of product presets; comprehensive product editing and storage
- ◎ 快速产品切换和自动调整相对应产品的分选速度
Rapid product switching and automatic adjustment of the corresponding product sorting speed

▶ 选配Optional

- ◎ U盘接口 USB Port
- ◎ RS485接口/喷码机通信接口
RS485 Port/inkjet printer communication interface
- ◎ 声光报警灯
Sound-light tri-colour alarming lamp

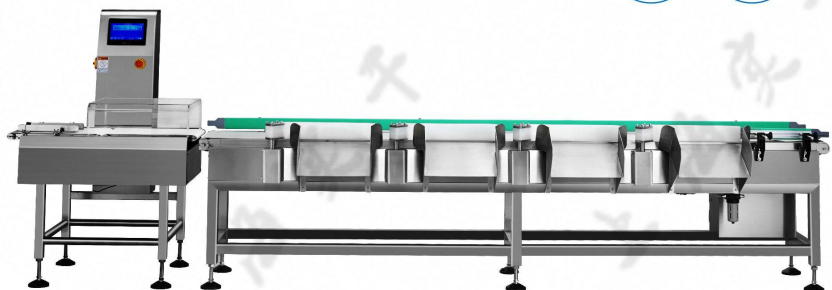

型号: Type	SG-D300
称重范围: Weighing scope	5-3000g/5000g
产品限制: Restrictions of product	L:350 W:300 H:3mm以上
分选精度: Accuracy	±0.5g-1g (视产品) (±0.5g-1g Depends on products)
分度值: Division Scale	0.1g
皮带速度: Belt speed	0-50m/min
最高速度: Highest speed	60pcs/min
皮带宽度: Belt Width	300mm
机器自重: Weight of Machine	≈60Kg+150Kg
电源: Power Supply	AC 220V±10% 50HZ
功率: Power	1400w
主要材质: Main Material	SU304 不锈钢 (SUS304 Stainless Steel)

>> SG-T300 称重贴标一体机 Check weigher and labeling machine Combo

▶ 功能特点Features

- ◎ 触摸屏人机对话
User-friendly operating system.
- ◎ 中英文操作界面
Chinese-English interface.
- ◎ 重量补偿功能
Weight of products can be compensated
- ◎ 柱状图和曲线图用来客户分析产品合格率
Product qualification ratio can be showed in line graphs and bar charts.
- ◎ 二级操作权限管理,支持自设密码
Two types of changeable password and login user rights for operators and administrator respectively.
- ◎ 可100个产品配方预设存储
100 kinds of data can be stored with strong data statistics function.
- ◎ 不合格产品多种剔除方式,支持不合格停机功能。
Support the function of non-qualified stop and multi-methods of rejection.



型号: Type	SG-T300
称重范围: Weighing scope	5-3000g/5000g
产品限制: Restrictions of product	L:350 W:300 H:3mm以上
分选精度: Accuracy	±0.5g-1g (视产品) (±0.5g-1g Depends on products)
分度值: Division Scale	0.1g
皮带速度: Belt speed	0-30m/min
最高速度: Highest speed	30pcs/min
皮带宽度: Belt Width	300mm
打印方法: (Print Methods)	热转印或直热式打印 (Heat transfer or direct heating printing)
打印规格: (Print Specifications)	最大打印宽度4.1英寸/104毫米 (Max Print Width)
分辨率: (Resolution)	每秒203dpi/8点或每毫米300dpi/12点 (dpi/8 points per second or 300 dpi/12 points per millimeter)
最大打印速度: (Max Print Speed)	每秒12英寸305毫米 (203和300dpi) (12 inches 305mm(203 and 300dpi) per second)
机器自重: Weight of Machine	≈200Kg
电源: Power Supply	AC 220V±10% 50HZ
功率: Power	≈300w
主要材质: Main Material	SU304 不锈钢 (SUS304 Stainless Steel)

>> SG-JS150 称重金属检测一体机 Checkweigher with Metal Detector Combo

金重检一体机是专门针对全自动包装线配套设计的在线检测设备,既可同时实现对产品重量的精确控制以及金属异物检测,并自动将重量不合格和含有异物的产品从生产线中剔除;节约空间,是生产线末端检测及质量控制最有效的解决方案

Checkweigher and Metal Detector Combo Machine is an on-line inspection equipment, specially designed for fully automatically packaging lines. It can not only achieve accurate control of product weight and metal detection, but also automatically remove products with unqualified weight and foreign objects from the production lines. Saving space, it is the most effective solution for end-of-line inspection and quality control.



设计优势 Design Advantages

- ◎ 结构轻巧,占地少,方便与生产线连接,检测灵敏度高,操作方便;可以在最大程度节省产线空间实现更多的质量控制。
Lightweight structure, less floor space, easy connection with production line, high detection sensitivity and easy operation; it can save production line space to realize more quality control.
- ◎ 技术先进,应用了最新的多频检测技术、物料效应自动消除技术、自动平衡技术和自适应调节技术为设备带来了行业内最简单的操作、最佳的环境适应能力和稳定性。
Advanced technology, applying the latest multi-frequency detection technology, automatic elimination of material effects, automatic balance technology and self-adaptive adjustment technology brings the industry's simplest operation, best environmental adaptability and stability to the equipment.
- ◎ 全不锈钢防震减震结构设计制作,保证长期稳定性和使用寿命。
All stainless steel shock absorber structure design and production to ensure long-term stability and service life
- ◎ 可以记录适合 100 种不同产品的检测参数,避免了由于人工差异导致的检测误差,避免更换产品的停工时间。
Can memory 100 different products of the detection parameters, to avoid the detection error caused by artificial differences, and the downtime of the replacement product .
- ◎ 低功耗设计和全密封设计以及设备的结构确保了防护效果电控部分防护效果好,达到 IP65 的防护等级,使用寿命。
Low-power design, full-seal design equipment structure ensure the protective effect of the electronic control part is best, and the protection level reach IP65,can last more than 15 years

型号: Type		数字式金属检测检重机 Digital Checkweigher with Metal Detector Combo (尺寸规格可根据要求定制 Accept custom)	
型号: Model	SG-JS150	规格: Specifications	4010
检测孔宽度: Detection of hole width	150mm	检测孔高度: Inspection hole height	100-200mm
检测灵敏度: Detection sensitivity	空机状态下: 高(H) 100mm: 铁 $\geq \phi 0.8\text{mm}$, 不锈钢 $\text{SUS} \geq \phi 1.2\text{mm}$ 高(H) 120mm 铁 $\geq \phi 1.0\text{mm}$, 不锈钢 $\text{sus} \geq \phi 1.8\text{mm}$ 高(H) 150mm 铁 $\geq \phi 1.2\text{mm}$, 不锈钢 $\text{sus} \geq \phi 2.0\text{mm}$ 高(H) 200mm 铁 $\geq \phi 1.5\text{mm}$, 不锈钢 $\text{sus} \geq \phi 2.5\text{mm}$		
有效检测孔宽度: Effective hole width detection	150mm		
有效检测孔高度: Effective hole detection level	100-200mm		
称重量程范围 Weighing scale range	5-500g		
称重精度 Weighing accuracy	$\pm 0.1\text{g}$ (视产品 Depend on product)		
传送带高度 Conveyor height	750mm ($\pm 50\text{mm}$)		
输送能力: Transmission capacity	10kg/times次	传送方向: Transfer direction	由左向右 From left to right
传送带最大速度: Conveyor belt maximum speed	25m/min	传送带材质: Material for conveyor belt	食品级 PU 带 Food grade PU belt
防护等级 Protection grade	IP65		
显示及操作方式 Display and operation mode	LED 液晶平面按键输入 LCD flat key input		
机器自重: Deadweight of Machine	$\approx 240\text{Kg}$		
电源要求 Power supply requirements	AC 220V 50Hz		
功率: Power	$\approx 300\text{w}$		
外形尺寸 Overall dimensions	About L2267XW589XH1500mm (最终按照设计图为准 Design drawing prevail)		

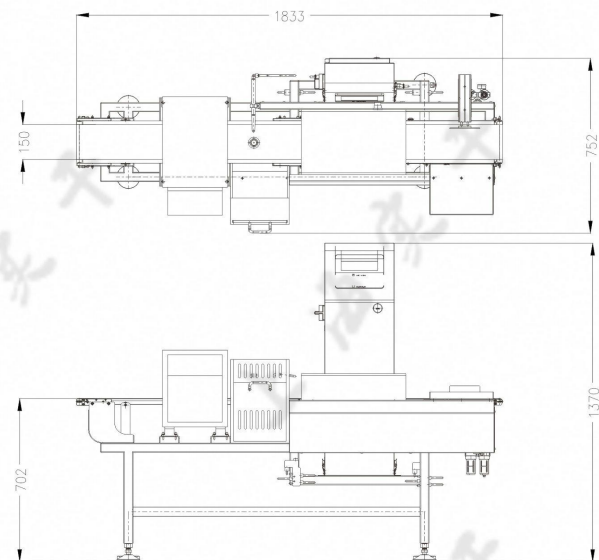

>> SG-M800 数字式全金属检测机 Digital All-metal Detector Machine

产品描述 The product description

全自动数字式金属检测机系统可以识别各种磁性以及非磁性金属(如铁、不锈钢、铝等),即便是细微金属嵌于产品中也可以被检测识别到。

Automatic digital all-metal detector machine system can identify the various of magnetic and non-magnetic metal (such as iron, stainless steel, aluminum, etc.), and even a tiny metal embedded in the product can also be detected.



设计优势 Design advantages

- ◎ 具备自动识别产品特性功能,100个产品信息存储功能、自动相位跟踪功能、输送带自动正反反转功能。
It has the function of automatic identification of product features, 100 product information storage function, automatic phase tracking function, automatic positive and reverse transfer function of conveyor belt.
- ◎ 采用先进的数字信号处理技术,提高了设备对产品效应的抑制能力,以及设备的稳定性。
Advanced digital signal processing technology has been used to improve the ability of the device to suppress the product effect and the stability of the equipment.
- ◎ 轻巧的机身设计节省流水线空间,全防水制作,适用于潮湿工作环境。
The lightweight fuselage design saves the assembly line space, all waterproof production, suitable for the wet working environment.
- ◎ 探测头和机架全不锈钢制作,卫生,耐用。
Probe head and rack all stainless steel production, sanitary, durable.

型号: Type		数字式全金属检测机 Digital All-metal Detector Machine (尺寸规格可根据要求定制Accept custom)	
型号: Model	SG-M800	规格: Specifications	4010
检测孔宽度: Detection of hole width	400mm	检测孔高度: Inspection hole height	100-200mm
检测灵敏度: Detection sensitivity	空机状态下: 高(H) 100mm:铁 $Fe \geq \phi 0.8mm$, 不锈钢 $SUS \geq \phi 1.2mm$ 高(H) 120mm 铁 $Fe \geq \phi 1.0mm$, 不锈钢 $sus \geq \phi 1.8mm$ 高(H) 150mm 铁 $Fe \geq \phi 1.2mm$, 不锈钢 $sus \geq \phi 2.0mm$ 高(H) 200mm 铁 $Fe \geq \phi 1.5mm$, 不锈钢 $sus \geq \phi 2.5mm$		
有效检测孔宽度: Effective hole width detection	400mm		
有效检测孔高度: Effective hole detection level	100-200mm		
传送带高度 Conveyor height	750mm ($\pm 50mm$)		
输送能力: Transmission capacity	10kg/times次	传送方向: Transfer direction	由左向右 From left to right
传送带最大速度: Conveyor belt, maximum speed	25m/min	传送带材质: Material for conveyor belt	食品级 PU 带 Food grade PU belt
防护等级 Protection grade	IP65		
显示及操作方式 Display and operation mode	LED 液晶平面按键输入 LCD flat key input		
机器自重: Deadweight of Machine	$\approx 180Kg$		
电源要求 Power supply requirements	AC 220V 50Hz		
功率: Power	$\approx 200w$		
报警方式 Alarm way	检测到金属,报警,皮带停止 Alarm, belt stop		

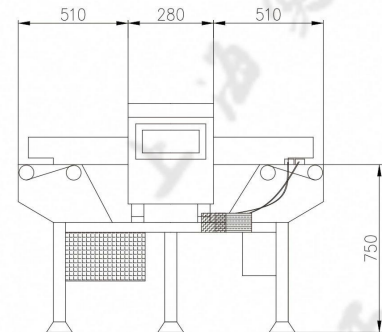
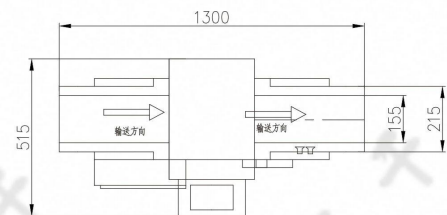

静态检重秤 Static checkweigher

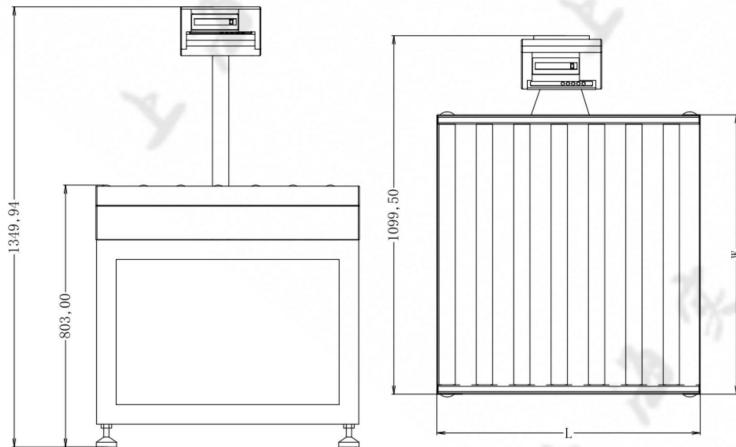

静态检重秤 Digital All-metal Detector Machine

功能特点 Features

- *具有检校秤之功能。(可以设定: HI, OK, LO三点)
- *具有自动校正、自动零点追踪之功能。
- *具有双重超载保护功能。
- *按键采用触感式设计, 采用3M胶贴防水性高。
- *外壳采用ABS塑料材质, 使用寿命长。
- *电力不足时有明确之低电压显示。
- *具有设计良好之运送保护功能。
- *大液晶LCD显示清晰易读, 具有EL背光功能。
- *电子显示头可调整适当的显示角度。

- With calibration scale function. (can be set: HI, OK, LO three values)
- With automatic calibration, automatic zero tracking function
- With double overload protection
- The key to take a touch design, using 3M stickers, high water resistance
- The shell is made of ABS plastic material, long service life
- When the power is not enough, there is a clear low voltage display
- With a well-designed transport protection
- Large-screen LCD display, clear and easy to read, with LE backlight
- Electronic instrument can adjust the appropriate display angle

选配 Optional

- 1: USB或者RS-232
- 2: 4-20毫安输出、0-5V
- 3: 三色报警灯
- 4: 热敏/不干胶打印机

- USB or RS-232
- 4-20 MA output, 0-5V
- Three-color alarm light
- Thermal printer/Adhesive sticker printer

客户: 重量: 20.0 kg 时间: 2012/11/14 08:32 西诺迪斯食品(上海)有限公司

客户: 重量: 20.0 kg 时间: 2012/11/14 08:32 西诺迪斯食品(上海)有限公司

热敏打印机:
打印尺寸: 57*50mm

Thermal printer
Print size: 57*50mm

2010-05-20 16:56:52 净重: 0.2000 Kg 皮重: 0.0000 Kg 总重: 0.2000 Kg 单重: 0.05 g/pcs 个数: 4000

2010-05-20 16:56:52 净重: 0.2000 Kg 皮重: 0.0000 Kg 总重: 0.2000 Kg 单重: 0.05 g/pcs 个数: 4000

上海实千实业有限公司 名称: 滚轮配件 货号: 2 净重: + 69.468 kg 毛重: + 8.088 kg 总重: + 69.468 kg

上海实千实业有限公司 名称: 滚轮配件 货号: 2 净重: + 69.468 kg 毛重: + 8.088 kg 总重: + 69.468 kg

不干胶打印机:
不干胶可以打印时间、净重、皮重、毛重、设置公司名称
打印尺寸: 60*60mm 50*30mm

Stickers printer:
Adhesive sticker printer can print time, net weight, tare, gross weight, set company name.
Print size: 60*60mm 50*30mm

序号 NO.	产品编号 (Product Number)	台面 (mm) Table size	量程 (KG) Weighing range	分度值 (g) Division Value
01	SG-HLGT (400*500)	W400*L500	30~300kg	2-20
02	SG-HLGT(600*800)	W600*L800	100~600kg	5-50
03	SG-HLGT (1000*1000)	W1000*L1000	0-1000kg	10-500
04	SG-HLGT (1200*1200)	W1200*L1200	0-1000kg	10-500
05	SG-HLGT (1500*1500)	W1500*L1500	0-1000kg	10-1000

>> SG-JC300

夹持输送机 Clamping conveyor

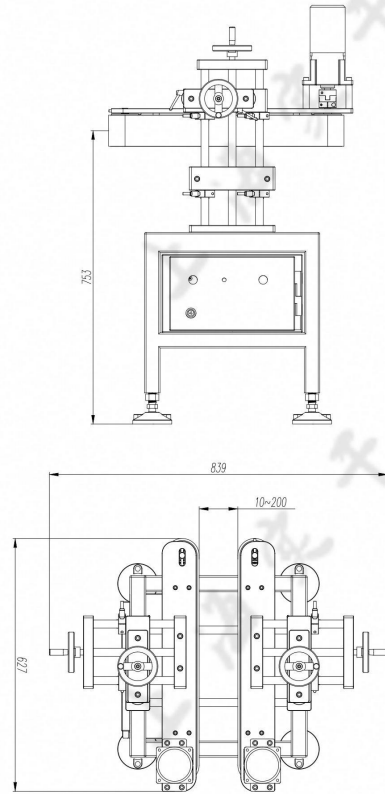

型号: Type	SG-JC300
夹持宽度: Clamping width	0-200mm
夹持高度: Holding Height	20-250mm
皮带速度: Belt speed	0-90m/min
最高速度: Highest speed	150pcs/min
皮带宽度: Belt Width	80mm
机器自重: Weight of Machine	≈50Kg
电源: Power Supply	AC 220V ± 10% 50HZ
功率: Power	≈200w
主要材质: Main Material	SUS304不锈钢 (SUS304 Stainless Steel)

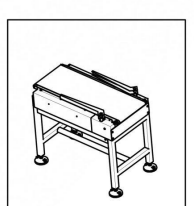
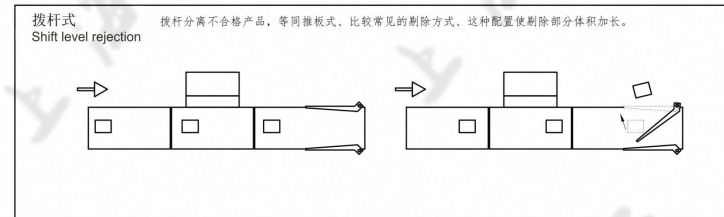
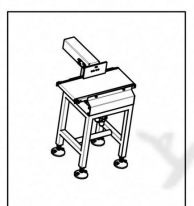
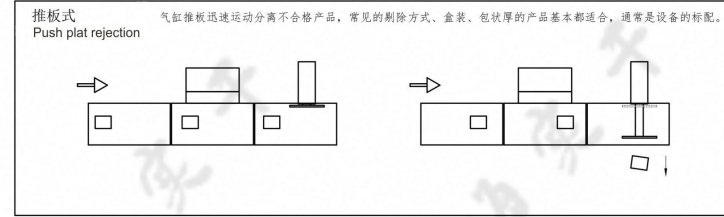
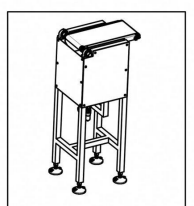
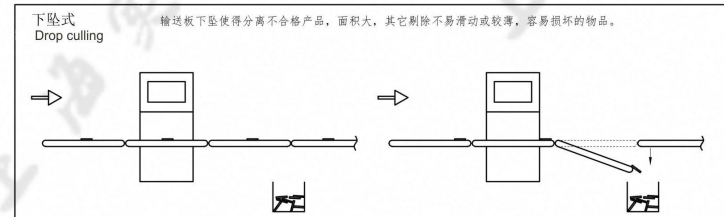
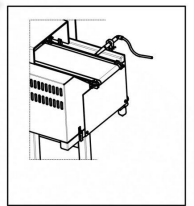
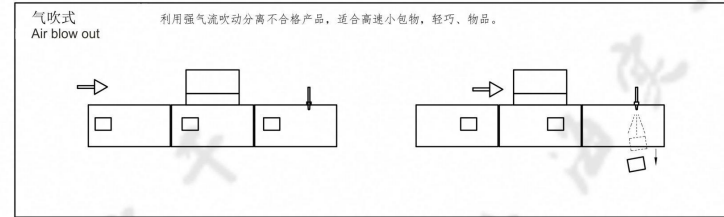
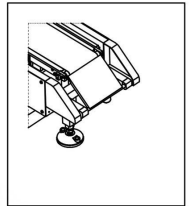
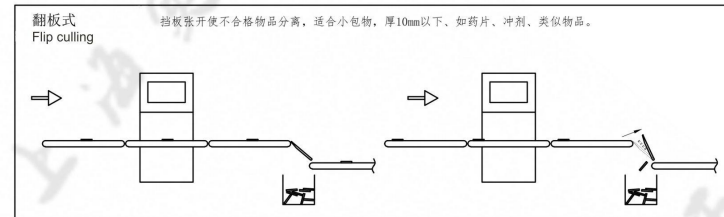

>> 倾情感谢



>> 生产流程 Manufacturing processes



>> 展会 Exhibition

