

SPRT®

SP-L36

Portable Thermal Printer

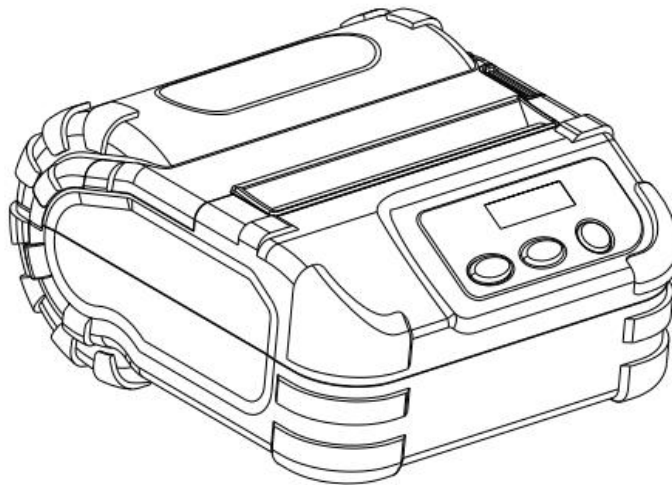

User's Manual
(ver 1.08)

Beijing Spirit Technology Development Co., Ltd

www.sprt-printer.com

CONTENT

NOTICE	1
Notice of Safety	1
Notice of Storing	1
Chapter 1 Outer Appearance and Model No.	2
1.1 Outer Appearance	2
1.2 Model No.	2
Chapter 2 Characteristic Specification	2
2.1 Printing Specification	2
2.2 Physical Parameters	3
2.3 Environment	3
2.4 other Specification	3
Chapter 3 Operation Method	4
3.1 Using Preparation	4
3.1.1 Battery Installation	4
3.1.2 Paper Roll Installation	4
3.1.3 Others	5
3.2 Basic function usage	5
3.2.1 Switch On	5
3.2.2 Switch Off	5
3.2.3 Self-Test	6
3.2.4 Paper Feeding (Manual Feeding)	6
3.2.5 Hexadecimal Printing	6
3.2.6 Printer Parameters Setting	7
3.2.7 Battery Charging	7
3.2.8 Enter program upgrade Mode	8
3.3 Printer Parameters Settings	8
3.4 Printer label sensor calibration	8
3.5 Restore the default configuration	9
3.6 Printer Interface Connection and Printing	9
3.6.1 USB Connection	9
3.6.2 Bluetooth Connection	9
3.6.3 WiFi connection	10
3.7 Buzzer	11
3.8 LCD indication	11
Chapter 4 Other Information	12
4.1 Command Programming Manual	13
4.2 Description of Black Mark Pre-print	13
4.3 Instruction on Label Paper	13
Appendix A	14
Appendix B	16

NOTICE

Please read this manual carefully before using the printer!

Notice of Safety

Be sure to use the specified battery and power supply provided by our company. Otherwise it may cause fire, explosion or damage printer, meanwhile, the battery also may be damaged.

Don't put battery into the fire, don't disassemble or heat the battery, don't be short circuit, it may cause fire, explosion or damage printer, meanwhile, the battery also may be damaged.

If the printer would not be used for a long time, be sure to take off the battery, otherwise the battery may leak liquid which is corrosive liquid, if improper operation causes battery leak liquid, and it paste in the skin or clothes, please rinse it by clean water, if paste in the eyes, please rinse them thoroughly by clean water and see a doctor. Please do not open the paper case cover when it is printing or just when printing is finished, do not touch the printer head with hand or body, overheat may cause scald.

Notice of Using

Pls do not print more than 1 meter receipt, or will cause damage to printer head .

Water or other liquid should not be spilled into the printer, also the printer should not be appeared in the rain, or else may cause printer damage. Please do not open the paper case cover when it is printing, otherwise the printer may work improperly. If printer is using USB connection to work, should not unplug the USB cable, or else some printing data may be lost. When printer is using Bluetooth connection to work, the distance of communication should be within 10 meters, otherwise the printer doesn't print or prints rubbish codes.

Too high (45°C) or too low (0°C) environment temperature and too high (85%) or too low (20%) environment humidity both effect the printing quality.

The printer paper roll with poor quality or stored for too long time also may reduce the printing quality even damage the printer.

Under the black mark detecting mode, the printer requires that the pre-printed black mark is accordant with the printing rule of black mark (please refer to details in Chapter 4.2), otherwise the black mark can not be detected correctly.

Pls do use the good label paper which is coincident with the requirements when the printer work under the label paper mode (pls refer to details in Chapter 4.3), otherwise, the printer may be not able to check the labels exactly.

Be sure to use up the power of the battery before charge up it, as it can ensure the using life of the battery.

Notice of Storing

The printer should be placed in such an environment that the temperature is between -20°C and 60°C, and the relative humidity is between 10% and 90%.

If the printer will be stored for a long time, please be sure to take out the battery, otherwise may damage the battery and printer.

Placing the battery pack in an extremely high temperature environment may cause explosion or leakage of flammable liquids or gases.

Exposing the battery pack to extremely low pressure may cause explosion or leakage of

flammable liquids or gases.

Warning

This is grade A product, which may lead to wireless radio interference. Under this circumstance, it may need users to apply practical measures for this interference.

Chapter 1 Outer Appearance and Model No.

1.1 Outer Appearance

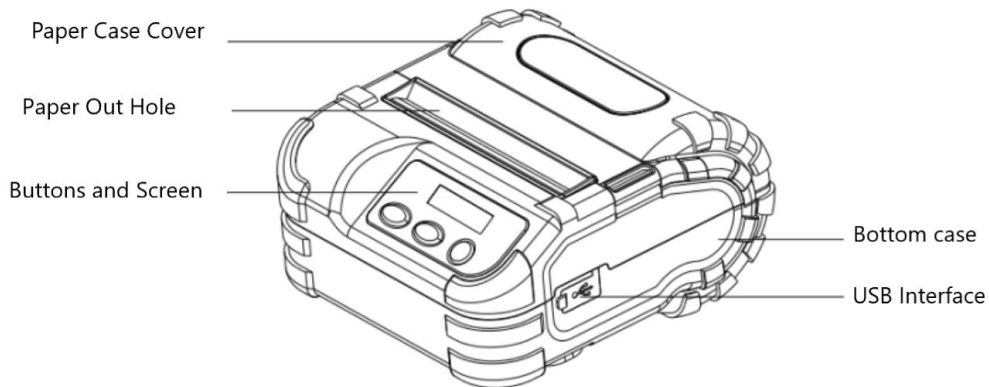

1.2 Model No.

Model	Interface
SP-L36BTDM	USB and Bluetooth
SP-L36W	USB and WiFi

Chapter 2 Characteristic Specification

2.1 Printing Specification

Printer Method: Thermal line
Paper Width: 79.5± 0.5mm, 57.5± 0.5mm
Effective Printing width:72mm,48mm
Resolution: 8 dots/mm (203dpi)

Dots in each line: 80mm: 576dots/line
58mm: 384dots/line
Printing Speed: thermal paper: 80mm/s (Max);
label paper: 60mm/s (Max)
Paper Thickness: 0.06-0.08mm (thermal paper);
0.06-0.15 (label paper)
Printable Content: GB18030 (Chinese), BIG5 (Traditional Chinese), GB12345 (Traditional Chinese), ShiftJIS Japanese Characters, ASCII characters, self-defining characters, bitmaps.
1D Barcode: UPCA,UPCE,EAN13,EAN8,CODE39,ITF25, CODABAR, CODE93, CODE128
2D Barcode: PDF417, QR CODE, DATA Matrix

2.2 Physical Parameters

Dimension: 123(L)X112(W)X67(H)mm
Physical Weight: 430g (excluding roll paper)
Paper Roll Diameter: ≤ 50.0mm
Interface: USB, Bluetooth, WiFi

2.3 Environment

Operating Temp: 0°C~50°C
Operating Humidity: 10%~80% (relative humidity)
Storage Temp: -20°C~60°C
Storage Humidity: 10%~90% (relative storage humidity)

2.4 other Specification

- **Paper Loading Method:** drop-in easy loading (please refer to details in 3.1.2 Paper Roll Installation).
- **Paper Tearing Method:** Manually tearing
- **Black Mark Location:** available(details please see 4.2 pre-printed black mark manual).
- **Printing Control Command:** ESC/POS compatible command set/CPCL command set. (Pls refer to the details in “The Commands Manual of SP-L36”).
- **Power Supply:** 7.4V/2100mAh rechargeable polymer lithium battery.
- **Low Power Alarm:** When the electric of battery will run out, the battery icon in the printer screen will flash.
- **Battery Charging:** quick charging, it will be charged full about 4hours;
- **Auto-sleeping:** If the printer doesn't receive any data or no any buttons operation within 5seconds, the printer will go into the auto-sleeping mode.

During auto-sleeping, press any buttons on the printer or the printer receives any data will call the printer on.

- **Battery Duration:** under 25% printing density, at least 200 meters, the standby time is over 4 days. These parameters are just for reference, long term usage will cause the capacity decline, and can not ensure the time of printing.

Chapter 3 Operation Method

3.1 Using Preparation

3.1.1 Battery Installation

1. Put the battery into the battery slot from the side with pins and press the other side into case.
2. Then tighten the M2.5*4 countersink screw (as below Pic.)

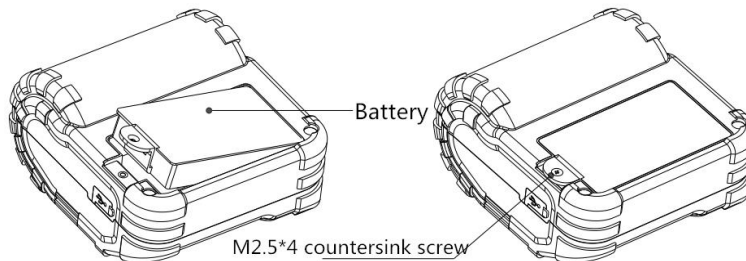

3.1.2 Paper Roll Installation

1. Press the OPEN button to open the paper case cover (as shown in Figure 1), put your finger in the finger groove in the baffle, slide the paper roll baffle outward till it is suitable for the width of the paper roll (as shown in Figure 2) .
2. Load the roll paper with the downward thermal face, pull out a part of paper and put them in the middle of the paper out orifice. (The end of paper is beyond the tear cutter.)
(see Figure 3).
3. Shut down paper case cover and cut off the redundant paper

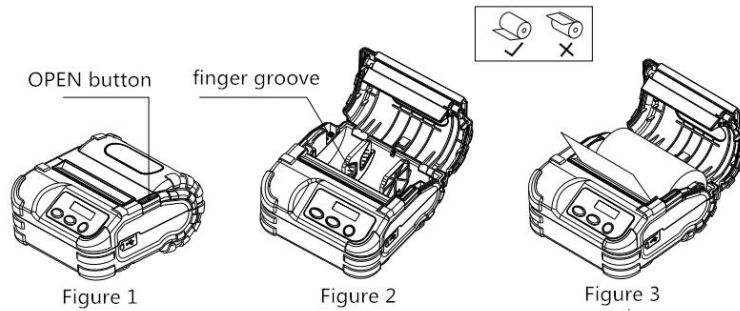

3.1.3 Others

Instruction for opening or closing the paper case cover: Opening or closing the paper case cover slowly after pressing the OPEN button.

Abnormal operation instructions: Paper blocking is not allowed at the outlet.

Placement direction: Hold it flat and try to ensure the stability of running paper roll when printing.

3.2 Basic function usage

Printing Modes: Standard Mode and Logistics Mode.

Paper Type: Thermal paper, Black mark paper and Label paper.

Logistics Modes: Way Bill mode, Receipt mode, Invoice mode. Label paper (80mm width) as default under Way bill mode. Receipt paper (58mm width) as default under Receipt mode. Black mark paper (58mm width) as default under Invoice model.

Standard Modes: 80mm mode, 58mm mode.

Standard thermal paper as default under Standard mode.

Printing modes or paper type can be set by Setting Tool (Way Bill mode and Invoice mode can't be changed under the logistics mode)

3.2.1 Switch On

Press the 【 POWER 】 button, you will hear 'one low one high 'prompt tone. "Loading..." will shown in LCD, then the printer turns into work mode when loosen the 【 POWER 】 button. Printer parameters will also shown in the LCD.

3.2.2 Switch Off

Under status of switch on, the printer will send out the prompt tone of 'one low

one high ' after pressing the **【POWER】** button, the LCD turns off, then loosen the **【POWER】** button, the printer switched off.

3.2.3 Self-Test

After receiving the printer, user can print the self test to check current settings and status of the printer at anytime.

The printing way is as below: Power off, then hold down the **【FEED】** button and press the **【POWER】** button at the same time. When you hear 'one low one high 'prompt tone and LCD shows "Loading...", loosen both**【FEED】**button and **【POWER】** button, the self-test will be printed out.

3.2.4 Paper Feeding (Manual Feeding)

A. Standard Mode:

Under the normal work status and apply to thermal receipt paper, press **【FEED】** button, the paper feeding begins, and stops when loosen **【FEED】** button. When the printer apply to black mark paper and label paper, press **【FEED】**button, the printer begins to feed paper and stops over the position of black mark/label spacing. If the paper is not the black mark/ label paper, the printer stops automatically after feeds paper for 26cm, and alarms the error of paper end for label paper.

B. Logistics Mode:

Under the normal work status and apply to receipt, press **【FEED】** button, the paper feeding begins, and stops when loosen**【FEED】**button. When the printer apply to invoice and waybill, press **【FEED】** button, the printer begins to feed paper and stops over the position of black mark/label spacing. If the paper is not the black mark/ label paper, the printer stops automatically after feeds paper for 26cm. And alarm the error of paper end for waybill.

3.2.5 Hexadecimal Printing

The function of hexadecimal printing is to print the data which received from host machine by hexadecimal numbers and corresponding characters. It will be convenient to debug program.

Enter hexadecimal printing mode: Power off, hold down the **【MODE】** button and press the**【POWER】**button at the same time. Then loosen the **【POWER】** button and press the **【FEED】** button when you hear 'one low one high' prompt tone of power on and LCD shows "Loading...". After that you may loosen the **【MODE】** button and **【FEED】** button. The printer enter the hexadecimal printing mode and print the notice.

Exit hexadecimal printing mode:The way to exit hexadecimal printing mode is

switch off the printer or press the **【FEED】** button for three times. The printer will also print the notice which shows that the printer have exit hexadecimal printing mode.

3.2.6 Printer Parameters Setting

Some simple parameters of the printer can also be set by operating buttons. There are two methods of entering parameter setting mode, which can set different parameters.

A. Under the state of power off, hold down the **【MODE】** button, then press the **【POWER】** button. Loosen the **【POWER】** button and **【MODE】** button orderly when you hear 'one low one high prompt tone and LCD shows "Loading...". The printer turns into the parameters setting mode. Press the **【FEED】** button or **【MODE】** button, LCD shows the first item which can be set parameters and the current numerical value. Details refer to Appendix A. Exit parameter setting: Hold down **【MODE】** and then **【FEED】** buttons, then loosen **【MODE】** button and **【FEED】** button. Saving the set parameters and exiting the parameter setting mode. The setting parameters won't be saved if you directly press the **【POWER】** button to turn off the printer.

B. Under the state of standby, press the **【MODE】** button to enter the parameter setting mode. Press the **【MODE】** button to select the setting parameter items, and press the **【FEED】** button to select the sub-menu of parameter items. Details refer to Appendix B. After setting the parameters, wait for 5 seconds, the printer will exit the parameter setting mode and save the setting values automatically.

3.2.7 Battery Charging

The battery will run out after a period of usage. When it nearly runs out, printer will give a alarm through the battery indicator flashing on LCD, at this time, user needs to charge up the battery.

Charging method is as following: connecting the adapter to the power socket with 220V, 50HZ, then plug the power charging plug to the power socket of the printer, then the power charging begins. During the charging process, the LCD screen of the printer will have a charging prompt.

In the power- off state: the icon shown with a plug image, and the battery power indicator icon is continuously changing to indicate that it is charging. Only one full battery icon is displayed to indicate that it is fully charged.

In the power-on state: the battery power indicator icon in the upper right corner of LCD is continuously changing to indicate that it is charging. If the battery power icon does not change, it indicates that it is fully charged.

3.2.8 Enter program upgrade Mode

a. Quick enter method

In the state of power-off, press both **【MODE】** button and **【FEED】** button. When hearing the 'one low one High' prompt sound, quickly release both buttons, the printer enters the program upgrade mode. At this time, LCD displays "Upgrading". Use "UpdateFirmware" (upgrade tool for PC) tool to upgrade.

Note: Only USB interface supports quick enter method.

b. Upgrade in printing mode:

In the power-on state, the printer can support printing mode upgrade when there is no error status. You can connect printer with PC by USB interface and use the "UpdateFirmware" tool to upgrade. Or "SprtPrinterUpdateTools" can be used (mobile upgrade tool). Connected by Bluetooth or WiFi to upgrade.

3.3 Printer Parameters Settings

Users can set more parameters by using the specified <Setting Tool> software through computer. The setting includes: language, font, printing density, default codepage, Bluetooth device name and password, printing mode etc. The setting method please refer to the <Setting Tools Software Help> which offered with the software together.

3.4 Printer label sensor calibration

Label sensor calibration is to adapt to different types of label paper on the market. By adjusting the sensor configuration of the printer, the printer can correctly position the label.

When it is currently in label paper mode, press the [MODE] button, press and hold the [FEED] button, and then press and hold the [power] button when the power is off. When you hear the power-on prompt, release the [power] button and then Release the [FEED] button. Press the [FEED] button once again, then release [MODE]. The printer enters label calibration mode. And print out "Sensor calibration mode \ r \ n, please press the feed button \ r \ n".

Power off directly to cancel the calibration.

After pressing the paper feed button, the printer will feed the paper for a fixed length, and then print out the "maximum voltage value: xx.xV \ r \ n minimum voltage value: xx.xV \ r \ n paper sensor setting value: xx". If the paper type configuration is incorrect or the hardware cannot support the current printing paper, the words "paper type setting error auto exit" and "calibration error auto exit" will be printed separately.

3.5 Restore the default configuration

When the printer configuration item is incorrectly configured and cannot work normally, use this function to restore the factory configuration content.

In the shutdown state, first press the [MODE] button, press and hold the [FEED] button, then press and hold the [power] button, when you hear the power-on prompt and the LCD screen starts, release the [power] button, and then release [FEED] button. Press the [FEED] button three times, and then release the [MODE] button. The printer enters the factory reset mode. And print out the "Note: Set the recovery system to the default value, press the FEED button once to confirm. Direct power off cancellation" prompt.

Direct power off to cancel recovery.

After pressing the paper feed button, the printer will print out the words "Restore System Settings Successfully". After the recovery is complete, the printer will automatically shut down.

3.6 Printer Interface Connection and Printing

3.6.1 USB Connection

The standard configuration of the SP-L36 printer is equipped with a standard Type-C cable for connecting the printer with the main device. The USB of the printer belongs to the type of slave device (DEVICE); the shape and pin definition are as shown in the figure below:

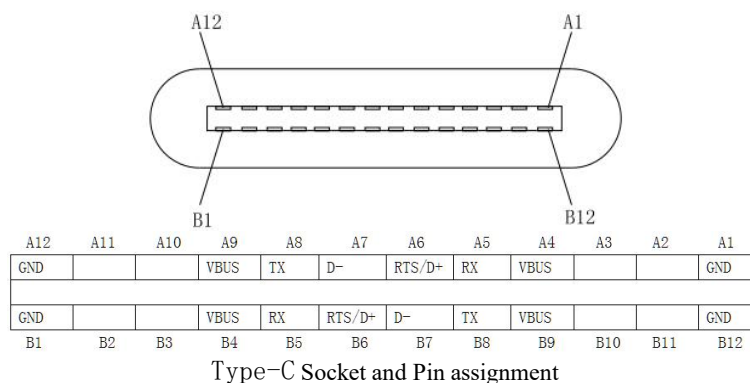

3.6.2 Bluetooth Connection

The devices, such as Hand-held device, laptop and other information terminal devices with Bluetooth can drive SP-L36 to print by the Bluetooth interface. SP-L36 portable printer is compatible with Bluetooth2.0 standard and dual Bluetooth(IOS Bluetooth 4.0 and Android Bluetooth 2.0) . Power class is

CLASS 2, effective communication distance is 10meters. The Bluetooth of the printer belongs to the slave device. The initial name of the printer is SP-L36 BT Printer, the initial password is '1234'; users can change the printer name and password by using<SP-L36 Setting Tools> software. Please see the details in help file of <SP-L36 Setting Tools>.

Before working, SP-L36 Portable Thermal Printer need to be pairing with primary device, matching begins with the host device. Usual matching course is as below:

1. Switch on printer;
2. Host device searches for the outer Bluetooth device;
3. If there are other Bluetooth devices, please select SP-L36 Printer;
4. Enter the password '1234';
5. Pairing finished.

Please see details in primary device Bluetooth function instruction for reference.

Notice:

1. When pairing, please make SP-L36 BT switch on.
2. Once SP-L36 has paired with the host successful, it can't be paired with other Bluetooth device until it unconnected with the host.
3. The power indicator flashing after paired successful. Printer LCD shows the connection state.

3.6.3 WiFi connection

Handheld devices with WiFi interface can be connected to a printer via WeChat for printing. The method of use is as follows:

1. Plug in the printer power and press the power button to make the printer power on.
2. Connect the mobile phone or tablet to a networkable router.
3. If the printer has never established a connection with this router, you need to first configure the network to connect the printer to the router.

Distribution method: Press and hold the printer's FEED button for more than 3 seconds, the printer will print out the QR code and follow the WeChat prompt to enter the router's password to configure the network.

4. After successful network configuration, the printer will print "Exit Network Configuration Mode", indicating that the printer has been successfully connected to the router. At this time, WeChat will scan the available printers in the local area and select the printer that has just been configured. Successfully bound the printer to WeChat and will enter the SPRIT public account. If you don't need to change the router, you don't need to configure the network, you

can directly enter the SPRUI official account. You can also scan the QR code on the bottom label of the machine and follow the prompts to skip the network configuration step and enter the public account directly.

3.7 Buzzer

There is also a buzzer to indicate various status of the printer. The meanings are as below:

One low one high: power on;

One high one low: power off;





Circulation continuous two lows: printer at mistakes status

3.8 LCD indication

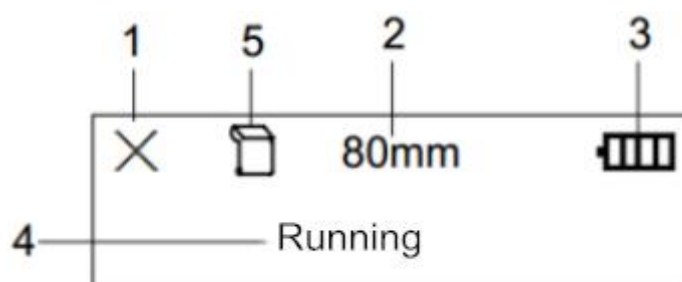
When the printer is turned on, the LCD screen of the printer will display a prompt message for startup. After the printer is initialized, the LCD will display the relevant information of the printer. If no data is sent to the printer or no external interface is inserted into the printer within 5 seconds, the LCD will automatically turn off the display. Until the external interface is plugged into the printer or the external device sends data to the printer.

1. Logistics mode:







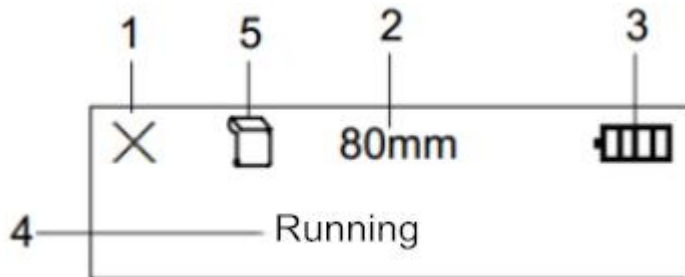

- ① When the icon is ×, it means that Bluetooth is not connected; when the icon is , it means that Bluetooth is connected; when the icon is , it means that WiFi is connected.
- ② Display the working mode of different printing paper, waybill mode, receipt mode and tax receipt mode.
- ③ Icons for the current battery power of the printer. The icons  for indicating current battery status. The icon  will flash when the printer power is low.
- ④ Text prompt display, where the current status of the printer is displayed in text.

When the printer is in normal standby, it is running.
 When the printer has a print job, it displays printing.
 When the printer makes an error, according to the error status, it will display out of paper, abnormal temperature, abnormal voltage and abnormal alarm of the paper compartment cover.

2. Standard mode:



- ① When the icon is ×, it means that the wireless is not connected; when the icon is , it means that Bluetooth is connected; when the icon is , it means that WiFi is connected.
- ② Display the working mode of different printing paper, 80mm, 58mm.
- ③ Icons for current battery power of the printer. The icons , ,  for indicating current battery level of the printer. The icon  will flash when the printer power is low.
- ④ Text prompt display, where the current status of the printer is displayed in text.
 - When the printer and peripherals are not connected, it displays: USB mode.
 - When a USB interface is inserted, it shows: USB is connected.
 - When the USB interface sends data to the printer, it displays: USB is communicating.
 - When there is Bluetooth connected to the printer and the corresponding port is opened, it shows: Bluetooth is connected.
 - When there is WiFi connected to the printer and the corresponding port is opened, it shows: WiFi is connected.
 - When a USB interface is inserted and Bluetooth is connected, it displays: USB and Bluetooth are connected.
 - When a USB interface is inserted and WiFi is connected, it displays: USB and WiFi are connected.
 - When the Bluetooth interface sends data to the printer, it shows: Bluetooth is communicating.
 - When the WiFi interface sends data to the printer, it shows: WiFi is communicating.

Chapter 4 Other Information

4.1 Command Programming Manual

<SP-L36 Technical Manual> is a technical manual for engineer to develop printer utility, and users can claim our company for it.

4.2 Description of Black Mark Pre-print

If user use pre-print black mark to locate the receipt, please be sure to abide by the following black mark pre-print regulation when printing the black mark paper, if not ,it will cause that the printer can not identify the black mark.

The black mark pre-print regulations are as below:

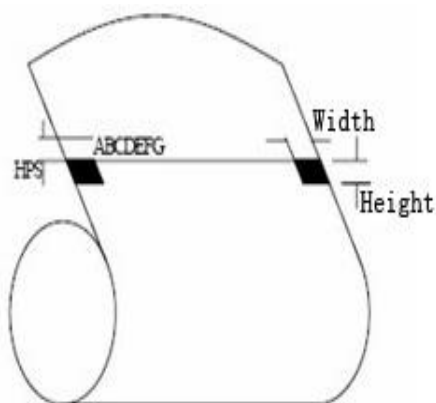

Printing Position: As the picture above, the black mark should be printed on the right or left edge of the side of words.

Width range: $\text{width} \geq 7\text{mm}$

Height range: $4\text{mm} \leq \text{height} \leq 6\text{mm}$

Reflectivity of infrared ray : $< 10\%$ (infrared ray reflectivity of other parts of the black mark paper is $> 65\%$)

HPS: it is the distance between edges of black mark and loading position.

$4.5\text{mm} \leq \text{Hps} \leq 6.5\text{mm}$

4.3 Instruction on Label Paper

Please do comply with the following instruction if the user adopts adhesive label paper, otherwise it may lead to the inaccurate locating the gaps, which results in the missed or blank receipt. Requirement on label printing paper:

1. The length of each receipt is less than 220mm
2. The gap width is less than 3mm, not more than 30mm
3. Requirement of receipt shape (rectangle or similar to), irregular shape

labels are not supported.

Appendix A

Setting instruction: hit the **【MODE】** button to choose “set” item; press it once, the set item will become the next alternative option, and it will print the present value of the chosen item. Hit the **【FEED】** button to set the value needed, when pressing it once , the value will become the next one in sequence

After setting, hit the **【MODE】** and **【FEED】** button together, the current value will be saved, and printer enters into normal operation status. Or it won't save the value.

General Setting:

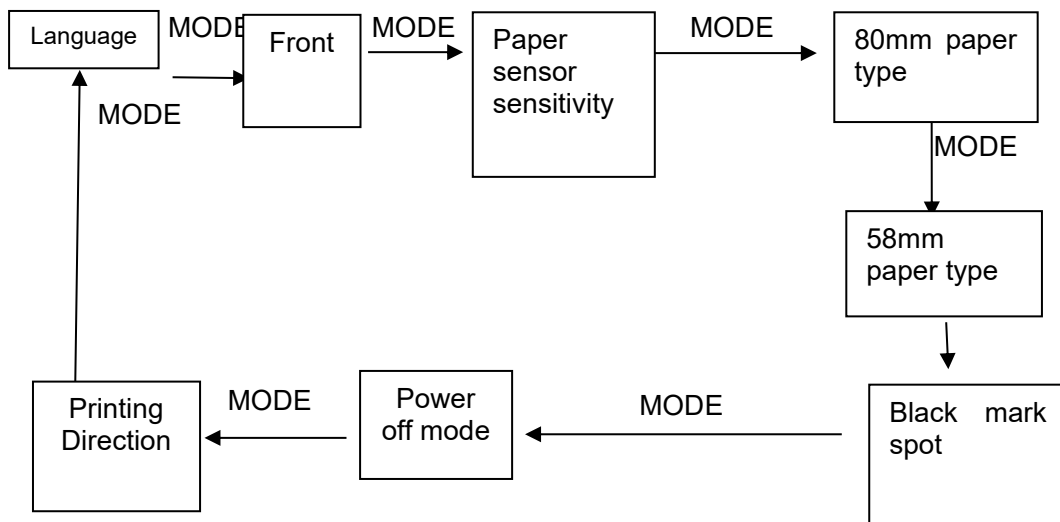

Language Setting:

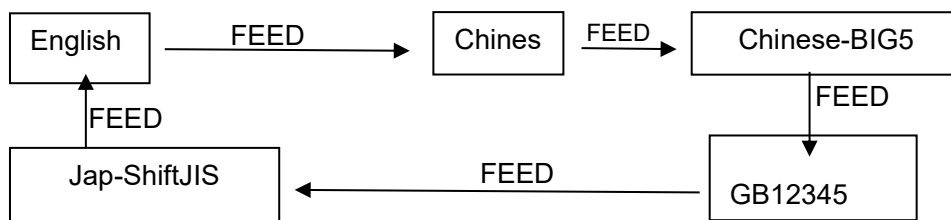

Font:

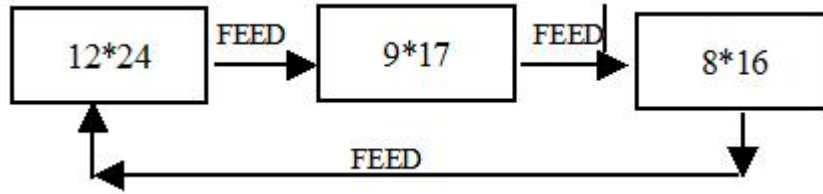

Paper sensitivity Setting:

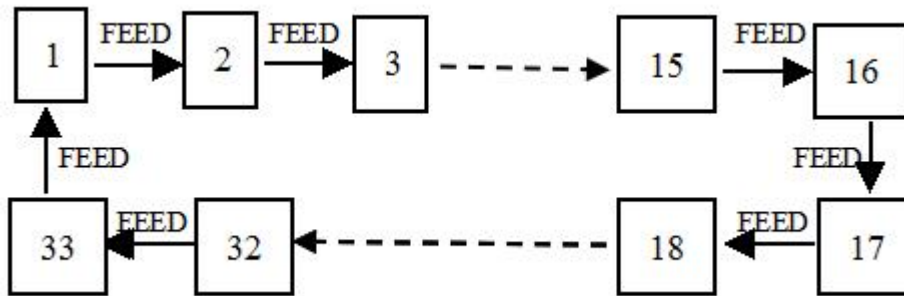

80mm/58mm Paper Type Mode:

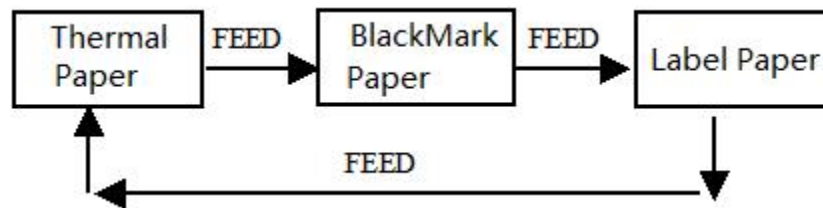

Black Mark Location Setting:

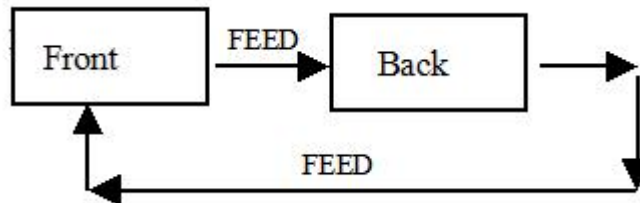

Power off Setting:

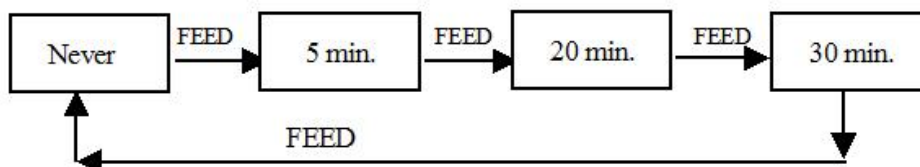

Printing Direction Setting:

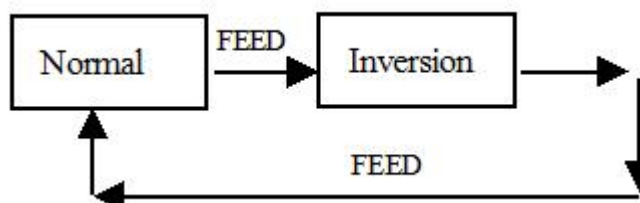

Appendix B

Setting instruction: hit the **【MODE】** button to choose “set” item; press it once, the set item will become the next alternative option, and it will print the present value of the chosen item. Hit the **【FEED】** button to set the value needed, when pressing it once , the value will alter to the next one in sequence

After setting, it'll quit the Setting mode automatically and save the current value after 5 seconds.

General Setting:

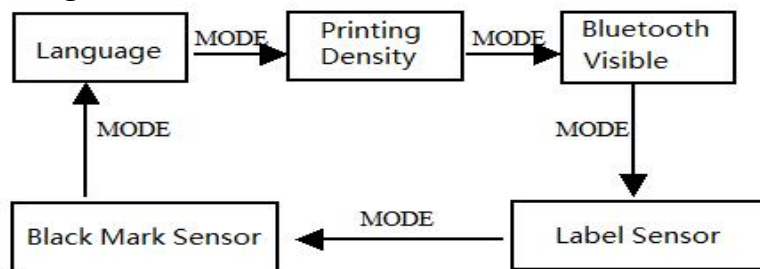

Language Setting:

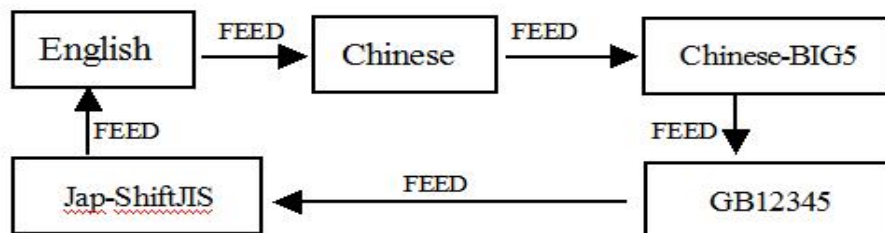

Density Setting:

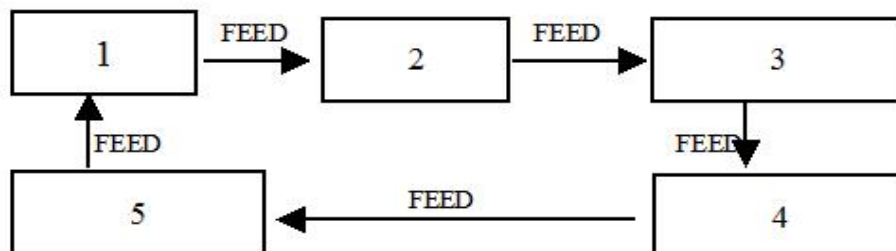

Visible Bluetooth Setting:

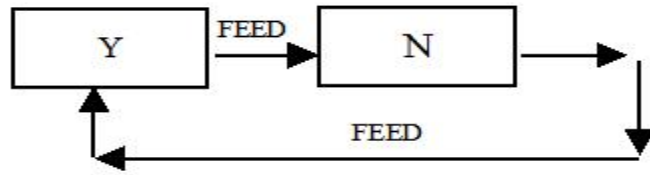

**Manufacture has right to amend the content of the
instruction without prior announcement!**

Beijing Spirit Tech Dev Co.,Ltd.

Add: No. 26 Ave. 4, Chuangye Middle Road, Shangdi Information Industry
Park, Beijing, CHINA

Zip code: 100085,

Tel: 010-51661178

FAX: 010-51661178-190

Technical support: 010-51661178-157 010-62969379

Service email: support@sprinter.com.cn