

USER MANUAL

Please read it carefully
before using and keep it well

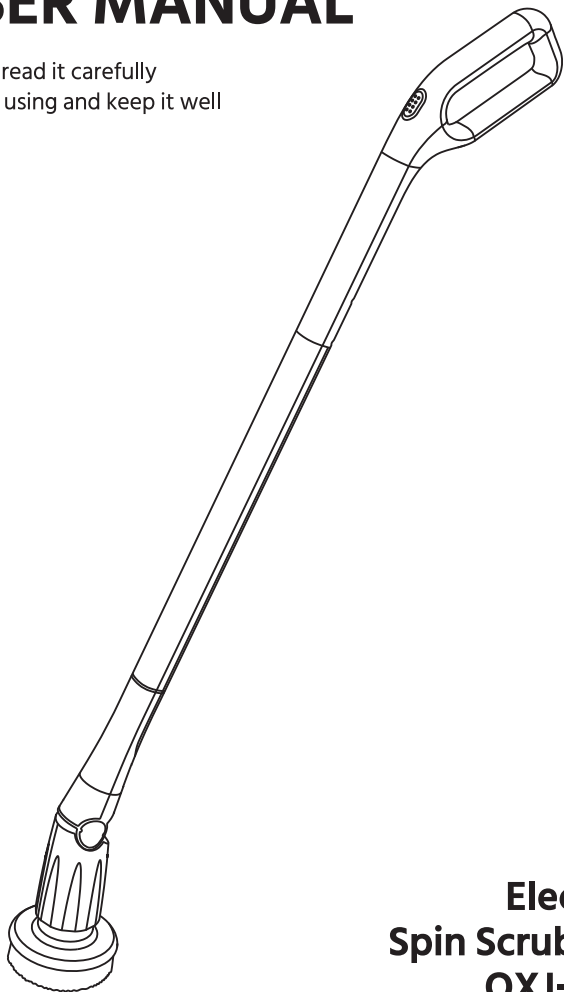

**Electric
Spin Scrubber
QXJ-M5**

In the box

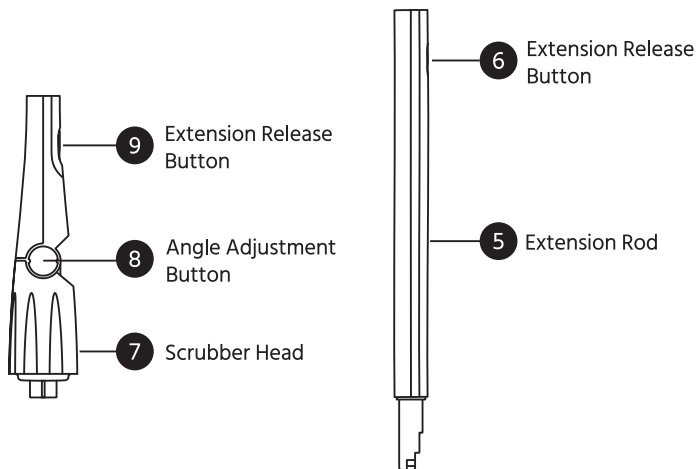
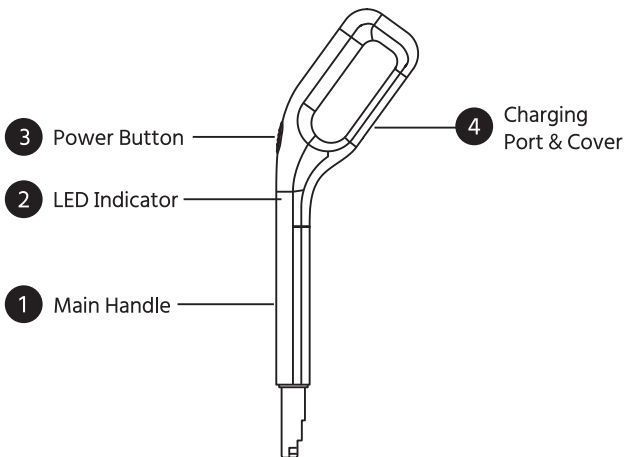



10 Dome Brush



11 Large Flat Brush



12 Flat Brush



13 Corner Brush

NOTE: Before assembling any component of this product, make sure the unit is turned off.

How to assemble the brush head ?

Hold the Scrubber Head with one hand and insert the selected brush head.

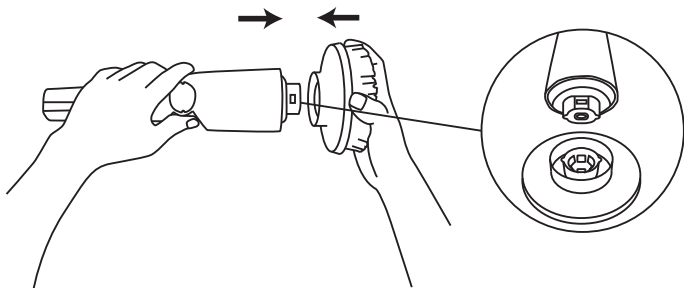

How to pull out the brush head ?

Hold the Scrubber Head with one hand and pull out the brush head.

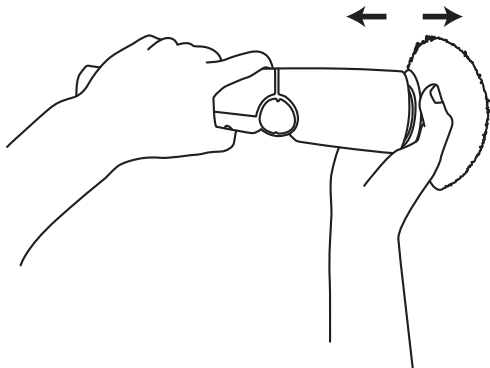

Assemble with Extension Rod

1. Connect the Main Handle to the Extension Rod until you hear a "CLICK".

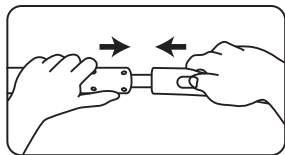

CLICK

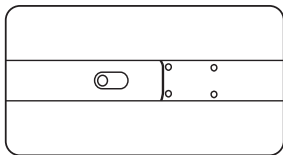

2. Connect the Scrubbe Head to the Extension Rod until you hear a "CLICK".

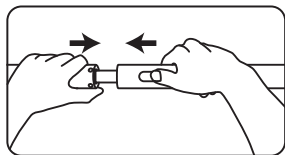

CLICK

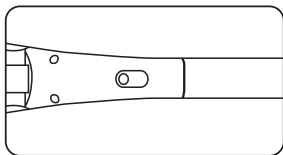

3. Assembly finished, as shown in the picture.

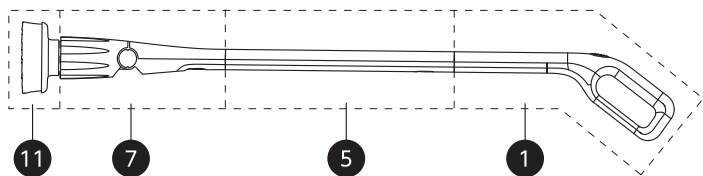

Assemble without Extension Rod

1. Connect the Main Handle to the Scrubber Head until you hear a "CLICK".

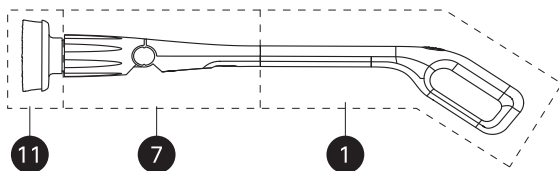

How to adjust the angle of scrubber head ?

Press and hold the 2 angle adjustment button (8) to adjust the scrubber head in your desired angle.

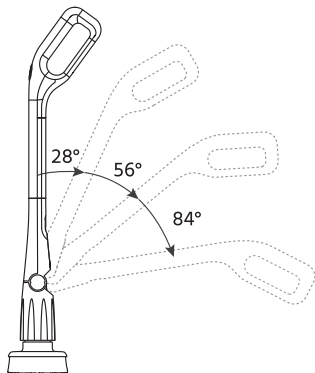
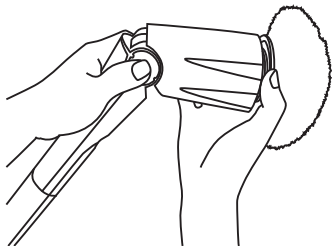

Suggestions for Use of Accessories



Dome Brush

Round Brush is perfect as a concave cleaning brush for shower, tub, bathtub, sink, baseboard, toilet.



Large Flat Brush

Large Flat Brush is used to clean large flat surface area, like hard floor, tile, wall, door, window, glass, counter, patio furniture, pool, soap scum, grime, stove, carpet, ceramic.



Flat Brush

Flat brush head ideals for cleaning smaller areas such as shower, kitchen, soap scum, grime, grease, stove, grill, counter, door.



Corner Brush

Corner brush is great for cleaning tile grout, edges, corners, cranny and tight places.

Charging your scrubber

Before using the spin scrubber for the first time or if indicator flash in white color, please fully charge the battery.

Open the silicone charging cover,
Insert the charging cord to the spin scrubber and USB Charger (Not Included), Plug the USB Charger into electrical outlet.

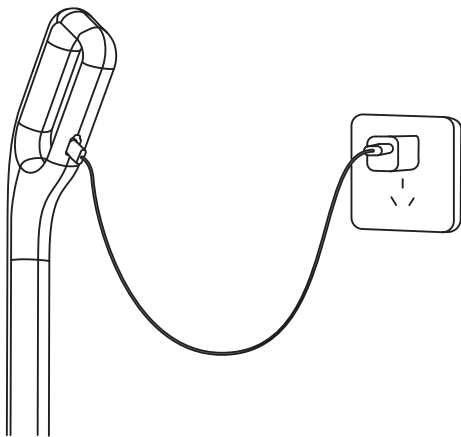

When the spin scrubber is fully charged, the 3 white indicators is solid on.
When the spin scrubber is being charged, the white indicator light flash.



How to work ?

Press the power button 1 time, power on, enter into low speed

Press the power button 2 times, enter into high speed

Press the power button 3 times, power off

Cleaning your scrubber

Handle Part

Gently wipe handle part of the scrubber with a wrung soft cloth.

Brush Head

Disassemble the brush head and immerse it into the water to clean.

Clean it with neutral detergent if it is difficult to clean.

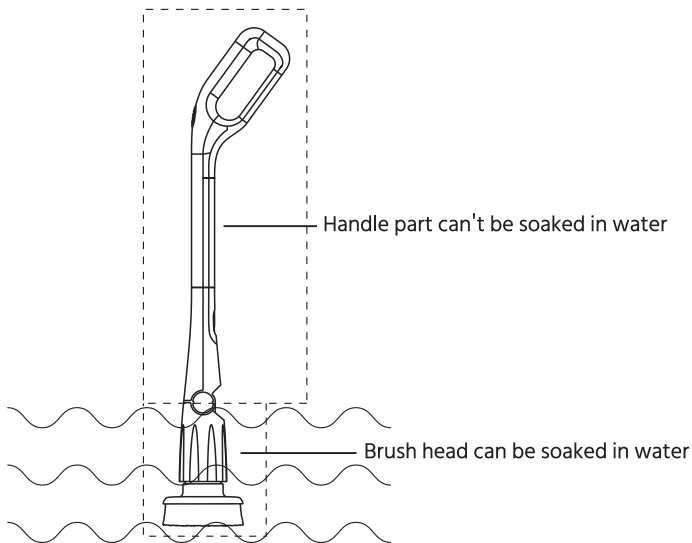

Cleaning Tips

For better cleaning effect, it is recommended to use the brush with detergent (such as Mold & Mildew Remover, Water Strain Remover, Oven Cleaner, Bleach Cleaner, All Purpose Cleaner). You could use different detergents for different needs.

For removing stubborn stains, please soak stains into water and detergent for a while, and then use the scrubber to clean, it will shorten your cleaning time.

Suggestion of Storage

Store the scrubber in a ventilated and shade place. Avoid placing it in a wet place or being exposed to strong sunlight.

Troubleshooting

Why doesn't the white indicator flash when charging?

Check if the charging socket is abnormal or power outage.

If the indicator light is solid white after plugging in the adapter, the product is fully charged, just turn it on to use.

The charging indicator light doesn't turn to solid white after charging over 3hours

Please check whether the socket and charging connection are loose, plug them tightly before charging.

If the product is immersed in water during use, it will damage the internal circuit and cause abnormal charging.

Why doesn't the brush head spin when the battery is fully charged ?

Please check whether the brush head is tightly connected with the extension rod and handle. For connection method, refer to the installation guide.

If it has been well connected and the product has not been soaked in water before, but the scrubber does not spin after turning on or it stops spinning without pressing the brush head too hard, please contact us.

Why does the brush head spin less than 90minutes when the battery is fully charged?

Each user may use different downforce during use. If you keep pressing the brush head too hard, the working time will be less than 90mins. In order to prolong the use time, please do not press the brush head too hard.

Warm Tips

- Allow for transportation safety, the product you received is not fully charged. Please fully charge the product before first use.
- Before using the scrubber, be careful not to get splashing stains into your eyes or on your skin.
- When the battery is low, the white indicator light will flash, please charge the product in time.
- When charging, the white indicator light is flashing.
- Please close the cover after charging to avoid water entering to cause the short circuit.
- Please check whether there are any missing parts after receiving the product.
- Please make sure that the scrubber is well-assembled before use.
- Small scratches may occur when cleaning the surface of stainless steel, polished resin, artificial marble, wood, etc., please try to confirm beforehand. Please try it out in a small area and make sure that there are no abnormalities before cleaning.
- It is recommended to rest the machine after working for 30 minutes.
- Brushes are consumable which are not applicable to the warranty.
- Please keep the charging cord and hands dry to avoid the risk of electric shock.
- Do not disassemble, repair or modify internal parts by yourself, please contact us if you have quality problems.
- Always use proper eye protection when using the scrubber with irritating substances.
- Rubber gloves are also recommended.
- When changing accessories, please make sure to turn off the machine first.
- Keep the hair, cloth or other parts of your body away from brush head to avoid convolving.

Warning

This appliance can be used by children age from 8 years and above and persons with reduced physical, sensory or mental capabilities or lack of experience and knowledge if they have been given supervision or instruction concerning use of the appliance in a safe way and understand the hazards involved. Children shall not play with the appliance. Cleaning and user maintenance shall not be made by children without supervision.

This appliance is not intended for use by persons with reduced physical, sensory or mental capabilities or lack of experience and knowledge, unless they have been given supervision or instruction concerning use of the appliance by a person responsible for their safety. Children should be supervised to ensure that they do not play with the appliance.

Warranty

We stand by our workmanship. If we made a mistake in building your scrubber, we will fix it or replace it.

FCC Statement

Operation is subject to the following conditions:

This device may not cause harmful interference.

This device must accept any interference received, including interference that may cause undesired operation.

Note

This device has been tested and found to comply with the limits for a Class B digital device, pursuant to part 15 of the FCC Rules.

These limits are designed to provide reasonable protection against harmful interference in a residential installation. This equipment generates, uses and can radiate radio frequency energy and, if not installed and used accordance with the instructions, may cause harmful interference to radio communications. However, there is no guarantee that interference will not occur in a particular installation. If this equipment does cause harmful interference to radio or television reception, which can be determined by turning the equipment off and on, the user is encouraged to try to correct the interference by one or more of the following measures:

- Reorient or relocate the receiving antenna.
- Increase the separation between the equipment and receiver.
- Connect the equipment into an outlet on a circuit different from that to which the receiver is connected.
- Consult the dealer or an experienced radio/TV technician for help.

Specification

| | |
|----------------|----------------------------------|
| Model | QXJ-M5 |
| Input | DC 5V 2A |
| Charge Time | 3 hours |
| Battery | Lithium ion Battery 7.4V 2000mAh |
| Running Time | 90 mins |
| Rotating Speed | Low: 220 rpm/min |
| | High: 260 rpm/min |
| Noise | <70dB |